



NSG 435 ESD SIMULATOR

USER MANUAL

601-131H

TESE

Advanced Test Solutions for EMC

NSG 435 ESD SIMULATOR
USER MANUAL

CONTENTS

1	General	5
1.1	Explanation of the symbols used in this manual	5
1.2	Safety	6
2	Introduction	8
2.1	Electrostatic discharge (ESD)	8
2.2	Simulation	9
2.3	Effects on the EUT	11
3	NSG 435	12
3.1	System description	12
3.2	The simulator	13
3.2.1	Function modules	13
3.2.2	Block diagram	14
3.2.3	Operating elements	15
3.3	System components	17
3.3.1	Basic set	17
3.3.2	Charging unit/battery-pack	17
3.3.3	Options	19
3.3.4	Mains power supply unit	19
3.3.5	Discharge networks	20
3.3.6	Remote triggering	21
3.3.7	Measurement adapters	22
4	Commissioning	23
4.1	Inspection	23
4.1.1	Function check	23
5	Operation	25
5.1	General	25
5.2	Switching on	25
5.3	Battery monitor	27

5.4	Air/Contact-discharge	28
5.5	Voltage	29
5.6	Polarity	30
5.7	Repetition frequency	31
5.8	Counter	31
5.9	Preselect counter	32
5.10	Automatic polarity switching	34
5.11	Continuous operation	37
5.12	Storing voltage settings	39
6	Test procedures	41
6.1	Standard-conforms procedures	41
6.2	Other conditions	41
7	Verification of the pulse data	43
8	Maintenance	44
8.1	Servicing	44
8.2	Calibration	44
8.3	Exchanging the R/C network	47
8.3.1	Derating of pulse repetition at increased capacitance	49
8.4	Repairs	50
8.5	Disposal	50
9	Declaration of Conformity CE	51
10	Technical specifications	52
11	ESD standards	54
12	Warranty	55
13	Ordering information	56
14	Addresses	57

1 GENERAL



1.1 Explanation of the symbols used in this manual

Please take note of the following explanations of the symbols used in order to achieve the optimum benefit from this manual and to ensure safety during operation of the equipment.

The following symbol draws your attention to a circumstance where non-observation of the warning could lead to inconvenience or impairment in the performance.

Example:



This connection must not be confused with the mains power input.

The following symbol draws your attention to a circumstance where non-observation of the warning could lead to component damage or danger to the operating personnel.

Example:



Never connect or disconnect the pistol while system is performing a test.

Symbols used on the product:



Danger
high voltage



Protective
earth terminal



Attention
refer to manual

1.2 Safety



This item of equipment, together with its accessories, works at high voltages of up to 16.5 kV. Any careless handling or non-observance of the operating instructions can have dangerous consequences.

The NSG 435 simulator is not a toy! It is a professional tool and belongs only in the hands of specialists and appropriately trained personnel.

When powered by its own batteries the simulator can be active even without any power cable being connected.

The instrument must not be switched on unless a correctly connected earth or ground cable (pulse current return path) is in place. The original earth cable supplied with the instrument is to be used. Any replacement cables must be fabricated in such a way that they cannot be accidentally connected to a mains outlet socket.

Do not touch the test finger! There is a danger of an unpleasant electric shock if the instrument is switched on (LC-display active).



Only trained personnel may operate the instrument.



Personnel fitted with a heart-pacemaker must not operate the instrument nor approach the test rig while it is in operation.

These operating instructions form an integral part of the instrument and must be available to the operating personnel at all times.

The instrument must not be used for any purpose other than testing the ESD immunity of electronic equipment.

The construction of the simulator is not designed for use in an explosive environment.

7



Each electrostatic discharge produces powerful electromagnetic interference.

Nearby electronic equipment can be seriously disrupted unless the appropriate counter-measures are taken. Perform ESD tests preferably in a shielded room.

The rechargeable batteries in the handgrip must not be short-circuited under any circumstances. They must only be recharged with the original charging unit supplied with the simulator. Should they have to be replaced, kindly observe the relevant recommendations for the disposal of nickelmetal hybrid batteries (if delivered before 2002).

The instrument must not be opened. Repairs, maintenance work and internal adjustments are only to be carried out by a qualified service engineer.

Use the instrument only in dry surroundings. Any condensation that occurs must be allowed to evaporate before putting the simulator into operation.

Long periods of exposure to sunlight and excessive warming by external energy sources are to be avoided.

Do not continue to use the instrument should any mechanical damage occur. The instruments housing has both an insulating and a screening function which can only be assured while the housing is intact. Return a damaged simulator to a Teseq service centre immediately for repair.

Teseq AG Luterbach, Switzerland and the associated sales organizations accept no responsibility for personal or material damage nor for any consequential damage that may result from irresponsible operation of this instrument.

T E S E Q

Advanced Test Solutions for EMC

2 INTRODUCTION



2.1 Electrostatic discharge (ESD)

Under appropriate ambient conditions, both material objects and even the human body itself can become charged with electrical energy. This effect is due to «electrostatics», a phenomenon that has been known since the earliest times. Thales von Milet (600 BC) noticed how amber attracted very light particles when it was rubbed. Touching a charged item against a conductive object leads to a charge equalization through a spark discharge which produces a brief but powerful electromagnetic field.

This effect can be explained as follow: Two insulating substances with differing dielectric constants become charged when rubbed together, i.e. one material gives electrons to the other one. This effect is known as electrostatic charging. The same can happen to a person. When somebody walks around in a dry atmosphere on a carpet with good insulating properties, a charge of several thousand volts can be built up. If, now, that person comes close to a conductive surface, the charge that he or she is carrying flows away through a hefty spark discharge.

The high equalizing current that flows, and the associated large electromagnetic field that hence results, can cause electronic devices (computers, terminals, process controllers, vehicle electronics, solid state devices, credit or memory cards, etc.) to malfunction or even be destroyed.

2.2 Simulation

A systematic investigation of electronic equipment and installations to determine their electromagnetic compatibility (EMC) is, today, a necessity if one is not prepared to suffer the economic disadvantages that could otherwise ensue. As a logical consequence, appropriate testing is now a legal requirement for the sale of electronic products within the EC.

The ESD test plays an important role in the range of interference sensitivity tests. It simulates frequently occurring effects and guides the development engineer to any weak spots in an instrument or item of equipment through a combination of high voltage and high frequency properties.

A simulation device must be constructed so that it reproduces practical conditions realistically. Furthermore, the results obtained (interference sensitivity threshold) must be reproducible.

The interference immunity of an instrument is not only dependent on its construction, it is also largely dependent on the quality or the consistency of the mass production techniques used. Knowing this has led to the demand for individual testing or at least random sample testing.

Further weak spots, which could affect the overall interference immunity, can arise through the assembly of instruments into complete systems because of the installation method used, the cabling and the earthing. An ESD check on systems is therefore also prescribed. Such tests provide valuable information about the immunity of the system to effects that occur only sporadically under operating conditions and hence represent difficult to detect sources of disruption.

- 10 The ESD simulator NSG 435 fulfils the requirements of various applications in an ideal manner:

Ergonomic shape	For nontiring use
Operation	Operating elements and display always in view of the user. Constant check on the test values.
Battery-powered	Independence from a mains power feed.
Compact and handheld	No bench unit as the high voltage source, no high voltage cable. Optimal freedom of movement around the device or system to be tested.
Carrying case	Simulator and accessories can be handily packed and conveniently transported.
Microprocessor-control	All the functions are «on-board», including a pre-settable counter, pre-programmed test values, discharge voltage measurement, etc.
Precision	The test parameters are maintained precisely for reliably reproducible tests.
Flexibility	The specifications prescribed in the standards are more than fulfilled in every respect. The instrument also offers many additional handy features.
Safety	The high voltage simulator is automatically deactivated if the instrument remains unused for a period of time.
Longterm operation	Automatic longterm operation for stationary applications with mounting on a tripod.
Application field	Development optimization, type approval, EMC certification, batch testing (individually), testing of fully installed systems.

2.3 Effects on the EUT

The most significant interference components of an electrostatic discharge are of a high frequency nature. The interference paths and effects have to be assessed in the range from about 30 MHz to the multi-GHz range.

The extremely rapid rise time of a discharge affects an object under test mostly through:

- magnetic HF-coupling between electrical conductors in the electronics and the discharge current path.
- electrical coupling between the discharge current and signal lines. A discharge current to the EUT flows proportionally through all the associated-conductors (earth, mains, data lines, screening, etc.) according to their relative impedance.

Malfunctions in insufficiently immune electronic equipment and systems make themselves apparent through:

- program crashes
- blocking of command sequences
- incorrect commands, statuses or data being processed
- partial system resets (e.g. only in peripheral modules which lead to errors that the system does not recognize)
- disturbance or destruction of interface chips
- destruction of insufficiently protected MOS or other components

ESD testing usually shows up all the weak spots in the HF-range of a piece of equipment simultaneously. The uses to which the NSG 435 simulator can be put hence go way beyond those called for in standard-conform applications.

This instrument provides the engineer with a means to detect sources of error caused by unsuitable earthing, poor ground connections, insulation problems, etc.

The simulator also serves as a reliable aid for localizing hidden wiring faults during acceptance trials on installations.

Use can also be made of the instrument as an insulation tester to determine the breakdown voltage of switches, relay contacts, insulators, etc.

3 NSG 435



3.1 System description

By using the latest materials, construction methods and manufacturing techniques for the robust housing shell, together with highly insulated modules, the newest high voltage technology and a control unit built using the SMD-technique, it has been possible to integrate all the functions that a comprehensive simulator system should offer into one compact instrument.

Professional industrial designers have ensured an optimized ergonomic concept. The instrument, with its well-balanced handgrip, sits comfortably in the users hand and guarantees non-tiring operation. Both the operating elements and the display window remain in view of the user while work is in progress.

Thanks to its battery pack, the NSG 435 offers optimal freedom of movement around the workplace and is an ideal test instrument not just for the development engineer but also for quality control purposes, system tests and for investigations in the field.

As supplied in the basic set, the system is equipped with a 150 pF/330 Ω discharge network for the IEC/EN 61000-4-2 standard. The discharge voltage of up to 16.5 kV for air-discharges and up to 9 kV for contact discharges ensure a comfortable test margin over and above the levels called for in the standard.

The instrument is well equipped to cope with other (and future) standards. The accessories include various networks and test fingers that can be attached by the user himself.

The basic set contains everything necessary for general use. For special tasks a rich assortment of accessories is available such as a mains power unit for longterm operation, a remote triggering unit via an optical link, spare battery-packs, discharge networks, test fingers, etc.

NSG 435 ESD simulator

3.2 The simulator

3.2.1 Function modules

The NSG 435 simulator is modularly constructed from a number of function units that are all housed in a multi-part, molded shell.



3.2.2 Block diagram

The function units are shown in the block diagram:

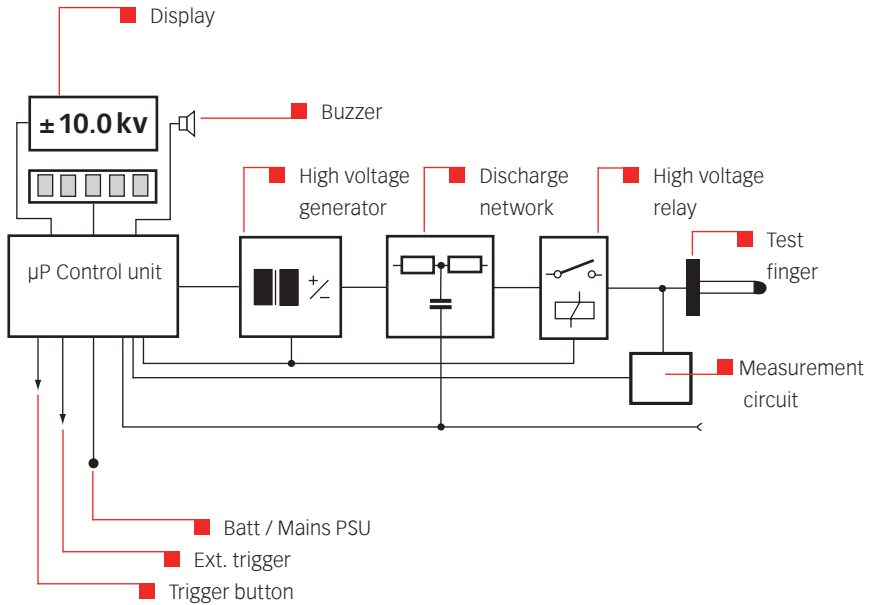

The microprocessor controls and monitors all the generator functions:

- Keypad entries are checked for plausibility. Unacceptable entries are rejected and an acoustic warning notifies the user of the error.
- Values entered are clearly shown on the large display screen. Further information shows the operating status and the counter settings.
- The battery charge state is continuously monitored. A tendency towards low voltage is shown on the display. The instrument's functions are inhibited once the battery voltage is insufficient to guarantee the pulse parameters.

- The high voltage generation is dynamically controlled by the processor. Varying load conditions, supply voltages, etc. can thus be taken into account and have no effect on the pulse parameters.
- The instrument switches itself off automatically if it is not used for a while. The pulse parameters and operating mode remain stored and ready for use once the simulator is switched on again.
- The charge voltage to the network is kept constant as long as the trigger is active. The high voltage is discharged internally when the trigger is reset.
- If no discharge occurs when set for an air-discharge and the trigger is active, the processor waits for about 15 s then autonomously resets the trigger and discharges the network internally. An acoustic warning is also sounded.
- A measurement facility at the pulse output measures the actual air-voltage reached during an air-discharge and shows the result on the display.
- Pulse triggering is monitored. Once an arc has occurred the network is discharged internally so that no further arcing is possible.

3.2.3 Operating elements

Apart from the trigger button itself (pulse triggering) all the operating elements are on the surface of the instrument that faces the operator.

The NSG 435 is switched on/off with the main switch.

The significance of the elements in the display field can be seen in the following picture. Further information can be found in section 5 «Operation».

Operation of the whole instrument is effected via the five multifunction buttons (soft-keys). These buttons perform different functions depending on the stage of operation. The current function is shown on the display in each case.

The designation F1 to F5 used for these buttons in the following notes serve to simplify the descriptions in this manual.

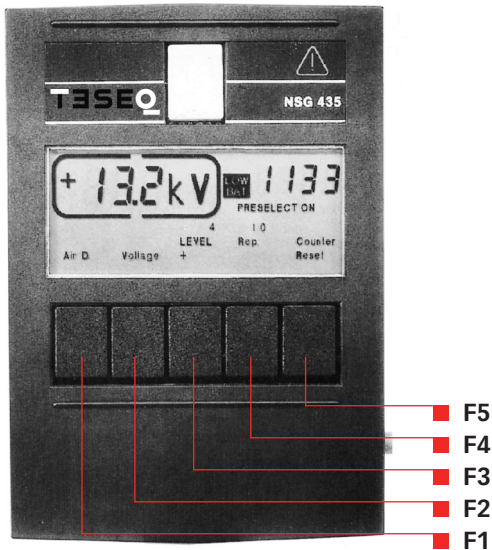

- F1**
 - Toggle between air and contact-discharge (and vice versa)
 - Increment voltage and counter

- F2**
 - Activation of voltage setting
 - Decrement voltage and counter

- F3**
 - Polarity switching:
 - Selection of pre-programmed test levels
 - Preselect counter on/off

- F4**
 - Selection of discharge mode:
 - Single discharge Repetitive discharge at 0.5, 1, 5, 10, 20, 25 Hz for air-discharge
 - Repetitive discharge at 0.5, 1, 5, 10 Hz for contact-discharge
 - Automatic polarity switching
 - Storage of programmed test levels

- F5**
 - Resets the counter
 - Return from second function

NSG 435 ESD simulator

The trigger button in the hand-grip works as follows, depending on the operating mode selected:

- For single discharge as a pulse button
(1 pulse when pressed)
- For repetitive discharges as on/off button
(discharge while the button is pressed)
- For repetitive discharges with preselect counter active as a holding on/off button
(switch on by pressing the button, switch off by pressing the button again)

The remote triggering facility is a substitute for the manual trigger button by producing the relevant control signals.

3.3 System components

3.3.1 Basic set

The basic set is packed in a practical carrying case and comprises:

- Carrying case 42 x 32 x 13.5 cm (16.5 x 12.5 x 5.5 " approx.)
- ESD simulator NSG 435 with battery-pack and 150 pF/330 Ω discharge network conforming to IEC/EN 61000-4-2, Ed. 1.2:2001
- One test finger each for air- and contact-discharges
- Earth cable
- Battery charger
- Operating instructions
- Calibration certificate

This set contains all the items necessary under normal conditions to perform tests conforming to IEC/EN 61000-4-2, Ed. 1.2:2001.

3.3.2 Charging unit/battery-pack

The battery charger supplied in the set is designed for multi-country use and is coming with various mains adaptors. Green LED shows fully charged battery status.

Operation range 100 V to 240 V (50/60 Hz)

Charging of the battery takes about 1 hour. For further details please refer to separate manual.

The battery has to be removed from the NSG 435 for charging via the jack connector. One charge is sufficient for several days of normal test operation.

Battery life expectancy:

Ambient temperatures over 50°C can lead to degradation of the battery. If treated carefully, more than 300 charge/discharge cycles can be expected without any noticeable reduction in capacity.

The charger and battery-pack form a matched entity. The battery must not be charged from any other unit and the charger is to be used exclusively for the intended purpose.

Operating advice:

- Avoid short-circuits. Keep the contacts clean
- Use the equipment only in dry surroundings
- Do not switch the mains off while charging otherwise the timer will be restarted
- Never leave the battery in a fully discharged state for a long time
- Do not attempt to recharge a full battery
- Recharge the battery about every 6 months even if the instrument is not being used

3.3.3 Options

A range of additional accessories is available for special applications and for testing to other standards:

- Spare battery-pack (space available in carrying case)
- Mains power supply with adapter
- Remote triggering unit with 5 m (197 ") optical cable
- Discharge networks and test fingers for other standards
- Coaxial measurement adapter (target)

3.3.4 Mains power supply unit

Instead of using the normal battery-pack, a mains power supply unit type INA 402 can be used for stationary applications and for longterm test purposes.



The handgrip adapter is an integral part of this power supply unit. It contains electrical components that are necessary for this mode of operation. It is not permissible to operate the NSG 435 with a power supply unit from another system.

The power supply unit can be used on all common AC mains supplies without having to make any adjustments, thus:

80 to 240 V (50/60 Hz) with 3-pin IEC connector
Matching 3-core mains cable

20 The power supply unit must be connected to a mains outlet having a protective earth.

The protective earth connection does not replace the earth cable for the operation of the NSG 435. To ensure safe and valid test operation the earth cable must be correctly connected as the pulse return path in every case.

The mains power supply unit is constructed in conformity with the relevant safety standards and carries the appropriate test symbol.

3.3.5 Discharge networks

The basic set contains a discharge network and test fingers that conforms to IEC/EN 61000-4-2, Ed. 1.2:2001.

Alternative networks can be installed for testing in accordance with other standards.

The discharge network and test fingers form a mutually matched combination. They are labeled with a corresponding INA number. The specified pulse data are only achieved while this combination is maintained.

Several combinations are given in the order list. The C and R values of the discharge network can also be specified for other applications.

Networks conforming to other standards can be built upon request. The specifications of the standard must be fully defined.

Exchanging the discharge network is described in section «Exchanging the R/C network».

3.3.6 Remote triggering

A remote triggering unit can be connected to operate the NSG 435 inside a Faraday cage with external pulse triggering or for test pulse triggering in synchronism with other conditions. The optical input for remote triggering is insensitive to external light sources.



The normal remote trigger unit consists of a «triggerbox» and 5 m (197 ") of optical cable. The remote trigger works in parallel with the «trigger-button» on the NSG 435. Pulse triggering, or the on/off switching in the case of repetitive discharges, can be effected by a push-button or an electrical signal applied to the triggerbox.

The electrical signal at the BNC connector must fulfill the following conditions:

On: $V = 2.4...10 \text{ V}$, $I > 2 \text{ mA}$, $t > 10 \text{ ms}$

Off: $V < 0.8 \text{ V}$

Repetition rate: $< 5 \text{ Hz}$

The remote trigger is powered by a conventional 9 volt battery. The current consumption is so low that a battery switch has been dispensed with. If NSG 435 provided with two optical connectors connect the optical cable to the blue terminal.

It is recommended to remove the battery if the unit is not going to be used for a long time.

3.3.7 Measurement adapters

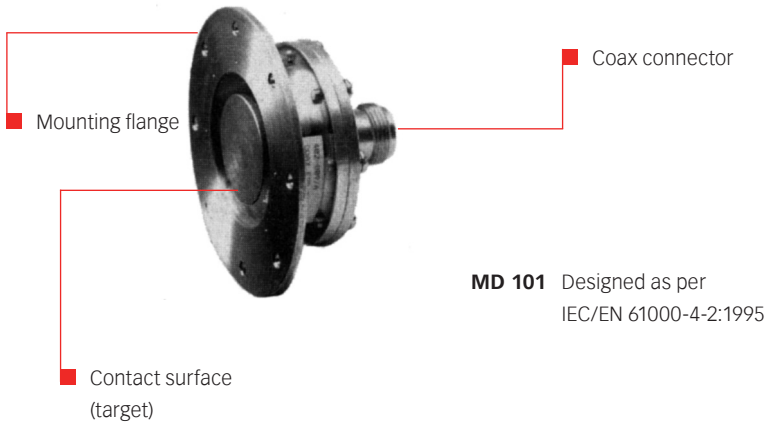

The measurement adapter type MD 101 as per informative annex B of IEC/EN 61000-4-2 serves to verify pulse amplitudes and pulse shapes. It is designed for mounting in the side wall of a Faraday cage in which an oscilloscope has been installed. This measurement adapter, also known as a «Pellegrini-Target» has the flat impedance curve to well over 1 GHz that is necessary for the purpose.

Use of this adapter is only worthwhile in conjunction with a test rig that is laid out in strict conformity with the relevant standard (see section 7).



MD 103

MD 103 («Pommerenke» target) is a more advanced coaxial measuring target with flat response characteristics up to the multi-GHz range. It may be used instead of MD 101.

NSG 435 ESD simulator

4 COMMISSIONING



4.1 Inspection

Immediately upon receipt, check the instrument and the accessories for completeness and look for any transport damage. Damage incurred in transit must be reported to the transportation undertaking without delay.

Before putting the instrument into operation:

- Study the manual
- Take the necessary safety precautions
- Charge the battery (see section 3.3.2)
- Connect the earth cable correctly (The NSG 435 must never be switched on without an earth cable being connected)
- Allow the instrument to dry out if any condensation has occurred

4.2 Function check

Inserting the battery

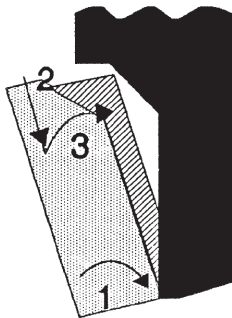

Insert the lower end of the battery (the part with the spring-blade) into the handgrip. Gently pull down against the spring so that the battery can be snapped inwards and then release the pressure.

24 Switch the simulator on with the main switch.

A display appears in the window showing values representing the status of the instrument before it was last switched off.

A typical set of values might look like this:

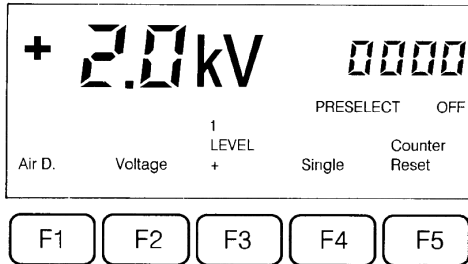

The instrument performs audible switching functions for a while that result from various self-tests and calibration procedures.

High voltage generation is activated by pressing and holding the trigger button. By bringing the test finger close to the earthing point an discharge occurs which is acknowledged acoustically and the display shows the effective discharge voltage in a frame. (This applies under the following conditions: air-discharge, single-pulse, preselect counter off).

The instrument is now ready to use.

5 OPERATION



5.1 General

This section provides a guide through the numerous setting possibilities of the NSG 435. The operation, which is strictly logical and hierarchically arranged, is easy to remember.

The display shows unmistakable information about the parameters that have been set and the operating status of the simulator. Equally logically, the instrument refuses to accept any invalid entries.

It is recommended to carry out the examples directly on the instrument (not forgetting to connect the earth cable!).

5.2 Switching on



Ascertain that the earth cable for the pulse return path is solidly connected to the fixed installation's earth point.

There is a danger of electric shock if this is neglected!

When the instrument is switched on, the last used settings will be reinstated. The following illustration is hence just one example from a multitude of possibilities.

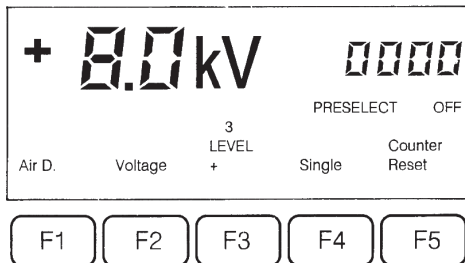

26

The instrument is ready for use immediately after the execution of a self-test and calibration procedure.

Press and hold the trigger button to activate the high voltage generation. The active high voltage state is shown on the display by the "kV" indication blinking.

The measured value of the breakdown voltage in air-discharge mode will be displayed. Differentiation from the display of the set value is made by the frame around the kV readings.

The effective discharge voltage depends on various factors such as the distance to the discharge point, speed of approach, nature of the EUT, etc.

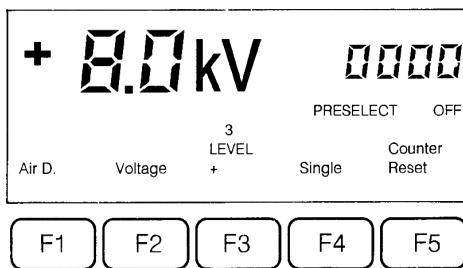

In the case of a contact-discharge this measurement is not carried out since only a discharge current can occur.

The instrument switches itself off automatically after a period of 30 minutes of non-use although the parameters that have been set will remain stored in memory.

5.3 Battery monitor

The battery charge state is monitored continuously. An insufficiently charged or empty battery is indicated on the display.

- «LOW BAT» blinks: Change or charge the battery soon. The instruments functions and the pulse data are still assured.
- «LOW BAT» steady: Battery empty. The instrument's functions are inhibited since the pulse data can no longer be assured.

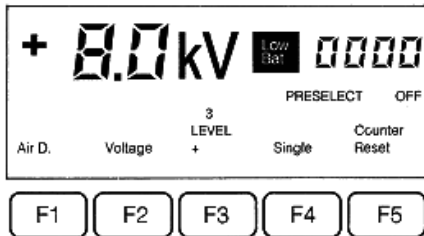

Note: One battery charge will last for several days of normal test operation. The useful working time depends, of course, to a large extent on the operating conditions.

The following figures have been obtained by way of reference:

- Battery freshly charged
- Air-discharge at 15 kV
- More than 10000 discharges until «LOW BAT» blinks
- A further 3000+ discharges until «LOW BAT» remains constant

5.4 Air-/Contact-discharge

F1 toggles between air-discharge and contact-discharge and vice versa.

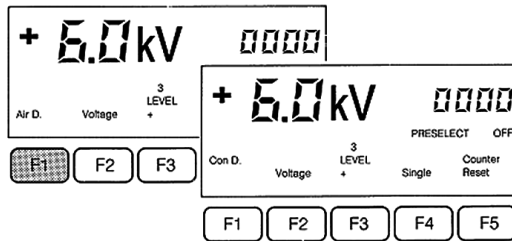

The change to contact-discharge is prevented if:

- The voltage set for this operating mode is too high, i.e. over 9 kV
- The repetition frequency set for this operating mode is too high, i.e. over 10 pulses/s

The instrument notifies the error with a beep and the erroneous setting blinks for 5 s.

When working with fixed voltage levels, the relevant value is automatically loaded upon toggling between the air/contact-discharge mode.

The corresponding test finger must, of course, be attached to suit the particular discharge mode:

Air-discharge = rounded test finger

Contact-discharge = pointed test finger

5.5 Voltage

Press F2 to branch into the submenu for voltage setting. Some of the other buttons take on different functions as shown on the display:

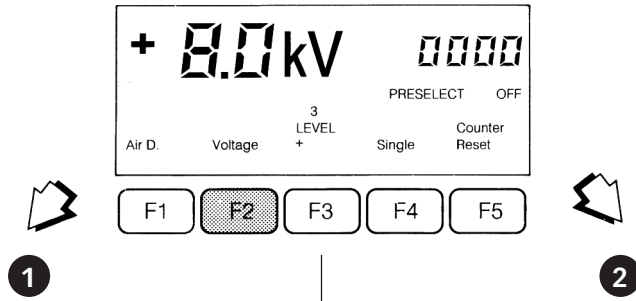

Free setting

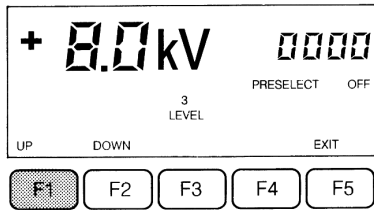

Pressing F1 or F2 raises or lowers the voltage respectively in steps of 100 V. Pressing the buttons continuously changes the voltage level with increasing rapidity.

Call stored values level 1-4 (4 values each for air-discharge and contact discharge)

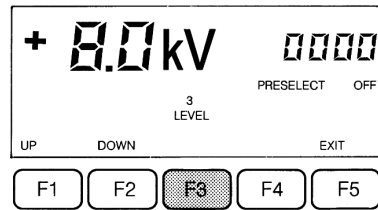

Press F3 to select the four stored voltage values in each case. (To change a stored value, see section 5.12).

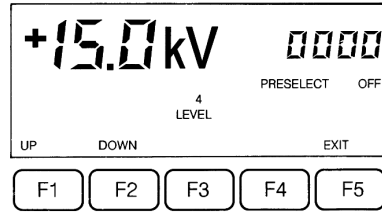
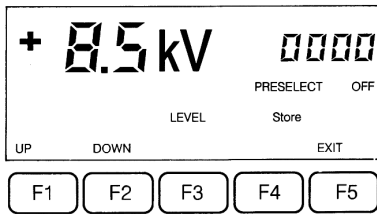

Press F5 to return to the starting menu level. (This return will also be made automatically after about 10 s).

5.6 Polarity

F3 toggles between positive and negative polarity. The sign shown in the display alters correspondingly.

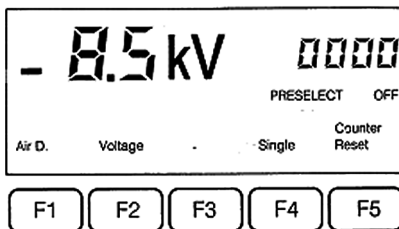
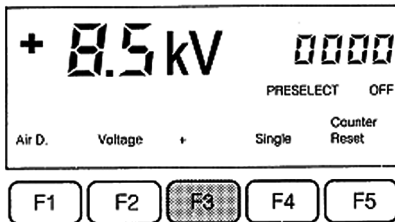

5.7 Repetition frequency

Use F4 to scroll from SINGLE (single discharges) through all the possible frequencies for repetitive discharges:

0.5/1/5/10/20/25 Hz for air-discharge

0.5/1/5/10 Hz for contact-discharge

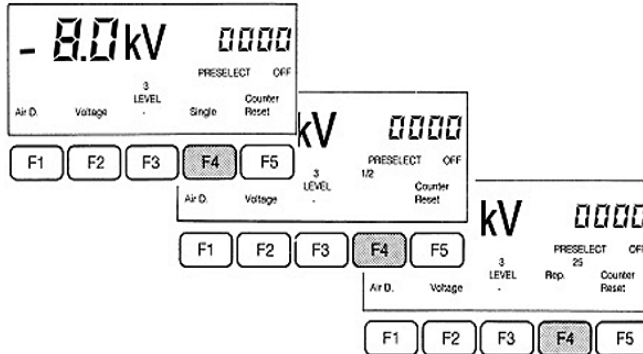

In the SINGLE mode a discharge is released each time the trigger button is pressed. The discharge is confirmed by a beep. In the REPETITIVE mode discharges are released at the chosen rate for as long as the trigger button remains pressed (no acoustic confirmation).

5.8 Counter

The counter sums the number of discharges, irrespective of the operating mode and irrespective of whether other pulse parameters have been set meanwhile.

The counter works in a decrementing manner in the preselect counter mode.

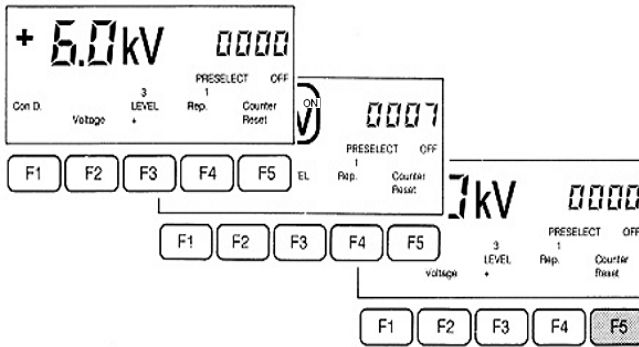

F5 sets the counter either back to 0000 or to the preset value if the preselect counter mode has been chosen.

Pressing F5 a second time causes a branch to the preselect counter menu.

5.9 Preselect counter

A specified number of discharges (0...9999) can be pre-programmed with this function. These can then be triggered single by hand or automatically.

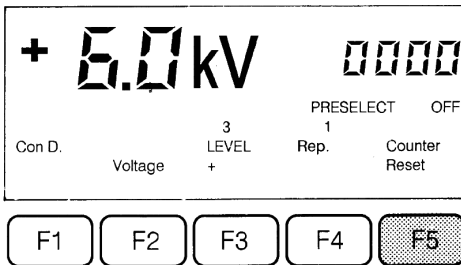

F5 first resets the counter then, when pressed a second time, branches into the preselect counter menu.

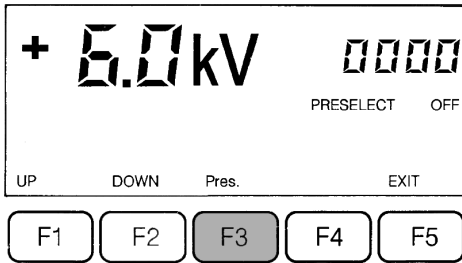

F3 switches the preselect counter operation on and off (PRESELECT ON/OFF).

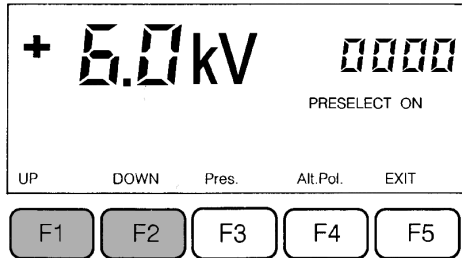

Use F1 and F2 to raise or lower the preset value. Keeping either button pressed causes the change to occur with increasing rapidity.

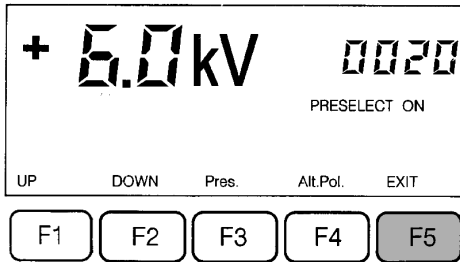

Press F5 to return to the original menu level. (This return also occurs automatically after about 10 s)

The preselect counter mode can be used with either single or with repetitive discharges.

Each time there is a discharge the counter content is decremented by 1.

In the repetitive mode the discharge sequence is started when the trigger button is first pressed and is halted when the button is pressed a second time. The sequence can be continued by pressing it again.

Pulse triggering is terminated when the counter content reaches 0000.

F5 reloads the preselect counter with the original value.

Once the counter reaches 0000 and the procedure has been stopped, the counter can also be reloaded with the original value again and the test sequence started anew simply by pressing the trigger button.

5.10 Automatic polarity switching

The IEC standards call for equal quantities of positive and then negative discharges to be applied to a test point. The NSG 435 can execute this function automatically.

The automatic polarity switch operates in conjunction with the preselect counter.

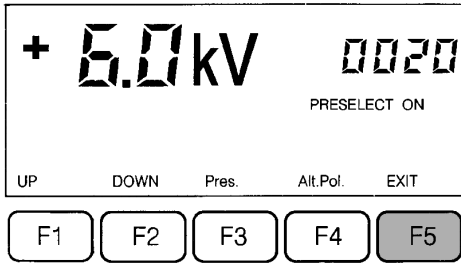

F5 branches into the preselect counter menu.

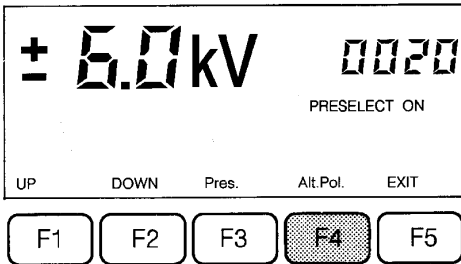

F4 switches the function «Automatic polarity change» on and off (Precondition: PRESELECT ON). The active state is shown by the polarity sign in front of the voltage alternating on the display.

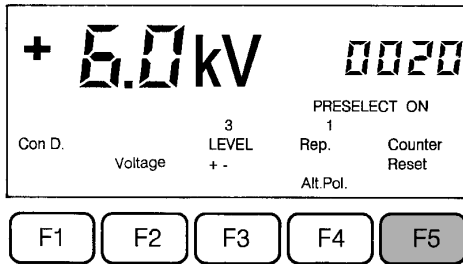

Use F5 to return to the original menu level. (This return also occurs automatically after about 10 s). The «Automatic polarity change» function is identified by «ALT. POL.» over F4 and +/- over F3.

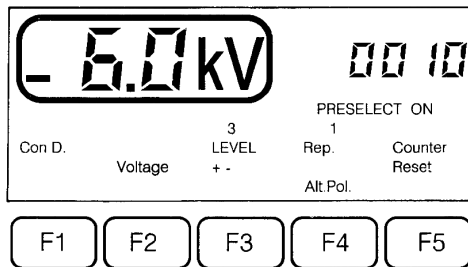

The instrument switches over from positive to negative polarity once half of the preset number of pulses has been released (the sign on the display changes).

This automatic function works in both the single pulse mode as well as with repetitive discharges.

Reinitialize the operation in single pulse mode after each cycle. Reset the counter and select the counter menu again (press F5 three times).

5.11 Continuous operation

A continuous operating mode can be selected for repetitive discharges. Pressing the trigger button starts the continuous operation; pressing it a second time stops the operation.



- Continuous operation should only be utilized in cases of real necessity since every ESD radiates electromagnetic disturbance the effect of which on the environment must be taken into consideration.
- The test area should be made out of bounds for unauthorized personnel.
- The test must be monitored throughout its duration.
- When running on batteries alone the duration of the test is naturally limited.

Activate continuous operation:

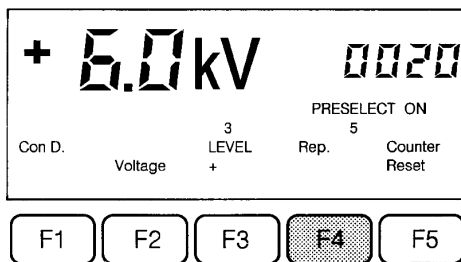

Select the repetition frequency in the basic menu with F4. By F5 branch into the preselect counter menu.

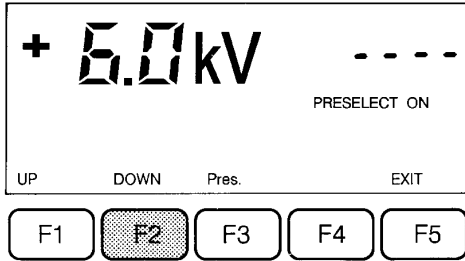

Hold F2 down until the counter content is 0000. Press F2 again to activate continuous operation. The display shows - - - -.

Use F5 to return to the original menu level.

Switching off continuous operation:

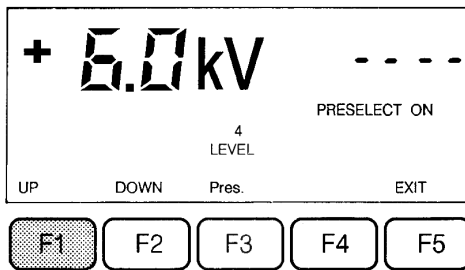

By F5 branch into the preselect counter menu. Press F1 or F2. The counter shows 0000 or 9999 respectively. Continuous operation is switched off.

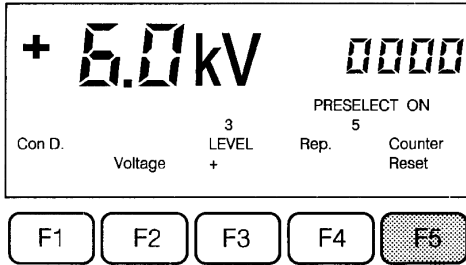

Use F5 to return to the original menu level.

5.12 Storing voltage settings

Pre-programmed discharge voltage values can be stored in four memory locations for both air and contact-discharges. As delivered, the instrument has the test levels set according to IEC/EN 61000-4-2, Ed. 1.2:2001.

Level	Test voltage contact-discharge	Test voltage air-discharge
1	2 kV	2 kV
2	4 kV	4 kV
3	6 kV	8 kV
4	8 kV	15 kV

The values stored in memory can be altered arbitrarily.

Select discharge mode (air-discharge or contact-discharge) with F1.
Call up «Voltage» submenu with F2.

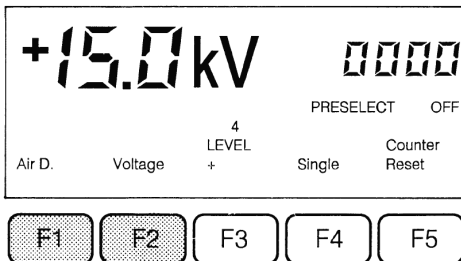

- 40 Set the required voltage with F1 or F2.
Range for air: 0.2 ... 16.5 kV
Range for contact: 0.2 ...9 kV

The «LEVEL» indication shown over F3 disappears. «STORE» appears over F4.

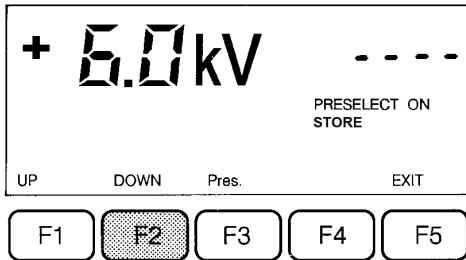

Press F4 and a memory location (1 ... 4) appears over F3.

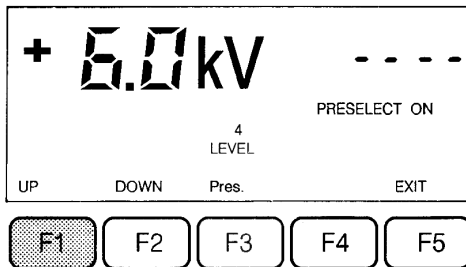

Use F3 to specify the required memory location. Press F4 again and the value is stored.

Use F5 to return to the original menu level.

6 TEST PROCEDURES



6.1 Standard-conform procedures

Test standards such as the IEC/EN 61000-4-2, Ed. 1.2:2001 give detailed information about setting up a test rig, the organization of a test and the documentation.

The ESD simulator system NSG 435 is constructed and calibrated in accordance with the requirements of the standards.

The test engineer cannot be relieved of the duty to study the applicable test prescriptions closely and to adapt the conditions to the test object in question.

The necessary documents can be obtained directly from the IEC, ANSI, IEEE, etc. or they can be obtained through the relevant national standards bureau.

6.2 Other conditions

It is not always possible to set up a test rig in precise conformity with the standards. By observing a few basics, however, it is nevertheless possible to make credible assessments of the interference immunity of a test object and to obtain worthwhile pointers to ways of improving it.

An electrostatic discharge always exhibits high frequency properties with parts of the spectrum extending to well beyond 1 GHz. Screening and filtering measures must therefore also be effective up into these frequency ranges.

The possible paths that the pulse may take have to be considered. The pulse return path must, without doubt, be through the earth cable connected to the simulator.

The contact-discharge method is to be used in preference to the air-discharge method. The former must, however, be implemented in such a way that there is a true metal-to-metal contact with the EUT.

Repetitive discharges can really be used only to localize weak spots or to find sensitive conditions in program sequences quickly. Single pulses then have to be used for a detailed investigation and assessment of the interference sensitivity.

The test conditions must always be documented exactly including photos of the test rig, information about the type and number of discharges, details of the prevailing climatic conditions, comments regarding the effects observed, etc.

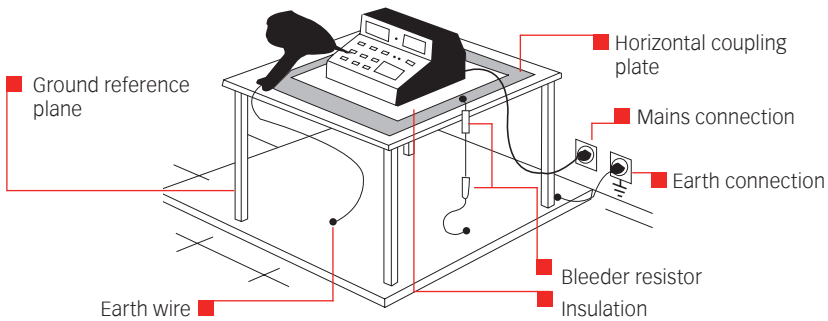

Example of a simplified test rig for a table-top instrument.

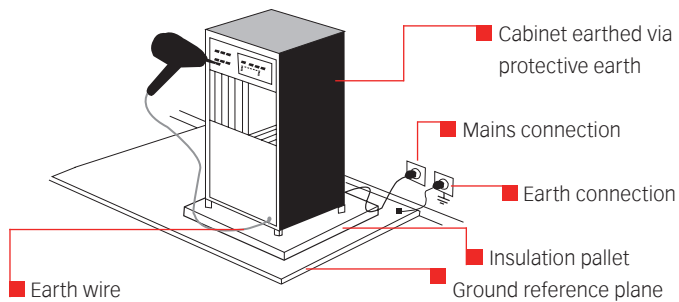

Example of a test rig for a system.

7 VERIFICATION OF THE PULSE DATA



The calibration and verification of the pulse data necessitates a specialized measurement equipment arrangement. The IEC standard lays down minimal requirements.

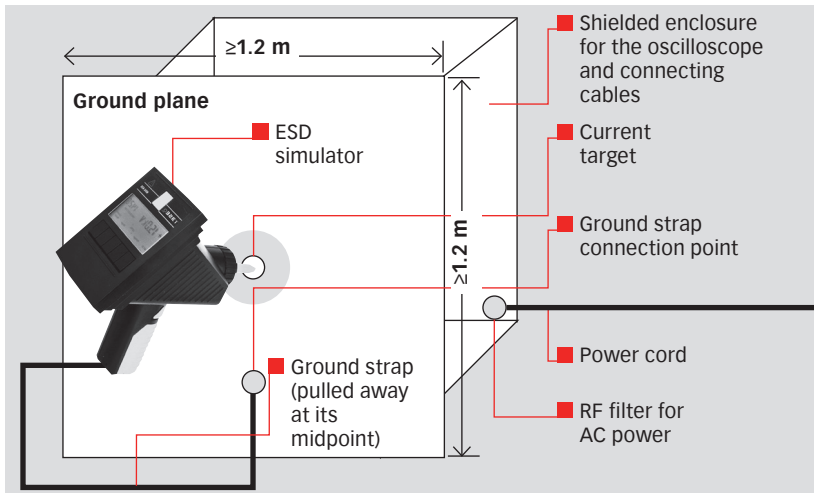

Teseq uses the following instruments for calibration purposes:

- Oscilloscope with >1 GHz bandwidth
- Coaxial measurement adapter MD101 (Pellegrini target as per IEC/EN 61000-4-2) or MD 103
- 20 dB attenuator DC-12.4 GHz - SUCOFLEX-HF-coaxial cable
- DC-High voltage voltmeter ($R_i > 30$ G Ω)

The measuring instruments are periodically recalibrated in compliance with ISO 9001 and ISO 17025.

8 MAINTENANCE



8.1 Servicing

Care

The housing may be cleaned with a moist cloth with possibly just a trace of detergent liquid.

Industrial spirit is also a suitable cleaning agent.

Other solvents are not permitted.

Fuses

The instrument contains no fuses that are accessible to the user.

8.2 Calibration

Trimming procedures in the NSG 435 are carried out digitally and automatically. The instrument contains no elements that are foreseen for adjustment by the user. A component defect must be suspected if the calibration measurements differ from the published technical data and the instrument is to be returned to an authorized Teseq service centre.

Measurements can only be undertaken by trained specialists. A prerequisite is the availability of the necessary measurement equipment as listed in section 7.

Charge voltage check

Equipment:

EHT voltmeter with 20 kV voltage range

Internal resistance > 20 G Ω

Measurement accuracy <1%

Check the voltage level under the following conditions

Air-discharge

Single discharge

Polarity: positive and negative

Voltage settings: 2, 4, 8 and 15 kV

Permissible deviation: $< \pm 5\%$ of the set value

Check the discharge current pulse shape.

Check to be made under the following conditions

Contact-discharge

Single discharge

Polarity: positive and negative

Voltage settings: 2, 4, 6 and 8 kV

Compare the results obtained against the reference figures quoted in IEC/EN 61000-4-2, Ed. 1.2:2001

Remark

Teseq offers an accredited service for this kind of work.

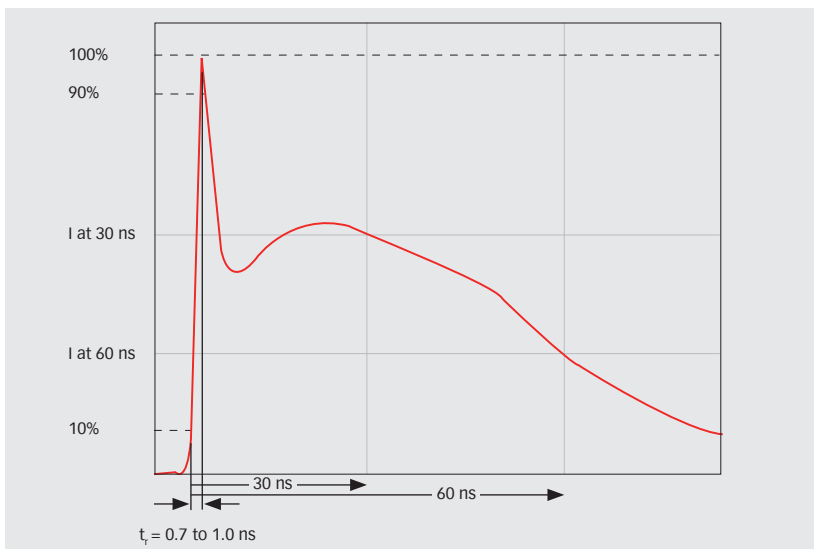

Level	Indicated voltage kV	First peak current of discharge $\pm 10\%$	Rise time t_r with discharge switch	Current ($\pm 30\%$) at 30 ns	Current ($\pm 30\%$) at 60 ns
1	2 kV	7.5 A	0.7 to 1.0 ns	4 A	2 A
2	4 kV	15 A	0.7 to 1.0 ns	8 A	4 A
3	6 kV	22.5 A	0.7 to 1.0 ns	12 A	6 A
4	8 kV	30 A	0.7 to 1.0 ns	16 A	8 A

These figures only apply to the discharge network and test fingers that comply with IEC/EN 61000-4-2, Ed. 1.2:2001.

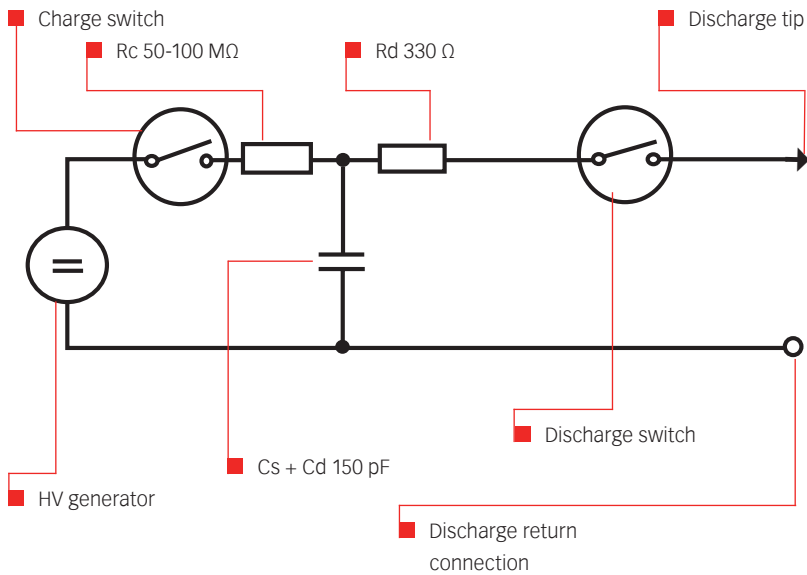

Teseq offers calibration services to carry out such work.

NSG 435 ESD simulator

8.3 Exchanging the R/C network

Exchanging the discharge networks is to be undertaken by knowledgeable personnel. A clean and well-lit working area is necessary.

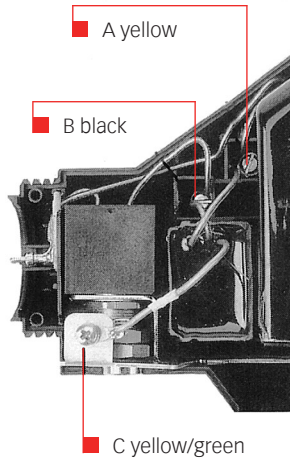
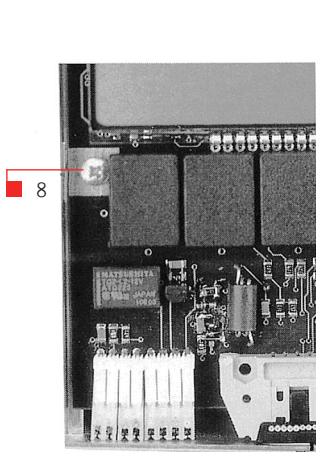

Procedure:

- 1 Switch the instrument off
- 2 Remove the earth cable
- 3 Take out the battery
- 4 Unscrew the test finger
- 5 Pull out the trigger button
- 6 Remove the rear cover
(the cover locks into 3 notches in the housing on both sides. The cover can be removed by carefully lifting it at the points where the notches are and gradually sliding it back).
- 7 Lay the instrument on its side and remove the screws
- 8 Remove the screw in the printed circuit board
- 9 Remove the upper part of the housing with a rocking movement
- 10 Note the arrangement of the wiring
- 11 Release the network connecting screws in the given order
- 12 Remove the network
- 13 Insert the replacement network
- 14 Firmly screw the color-coded network connections into place as shown in the illustration
- 15 Take care with the placement of the wires so that none becoming trapped while re-assembling the generator
- 16 Carefully screw the upper part of the housing back into place
- 17 Continue re-assembly in the reverse order of points 8 .. 1 above (attach the test finger belonging to the set!)
- 18 Check the operation of the generator by observing the spark-gap (the high voltage generator adjusts itself automatically to the new network)
- 19 If in doubt, a voltage check can be carried out as given in section 8.2
- 20 A calibration measurement is not normally necessary

8.3.1 Derating of pulse repetition at increased capacitance

When using special discharge networks with higher capacitor values, the maximum pulse repetition frequency will be automatically derated. This is the only consequence however of using high C networks.

No firmware modification of the NSG 435 is needed.

The figure shows the derating values for various capacitances versus the voltage.

If any selected parameter (repetition rate and/or charging voltage) should be out of range, same will be indicated by 3 beeps followed by a time out.

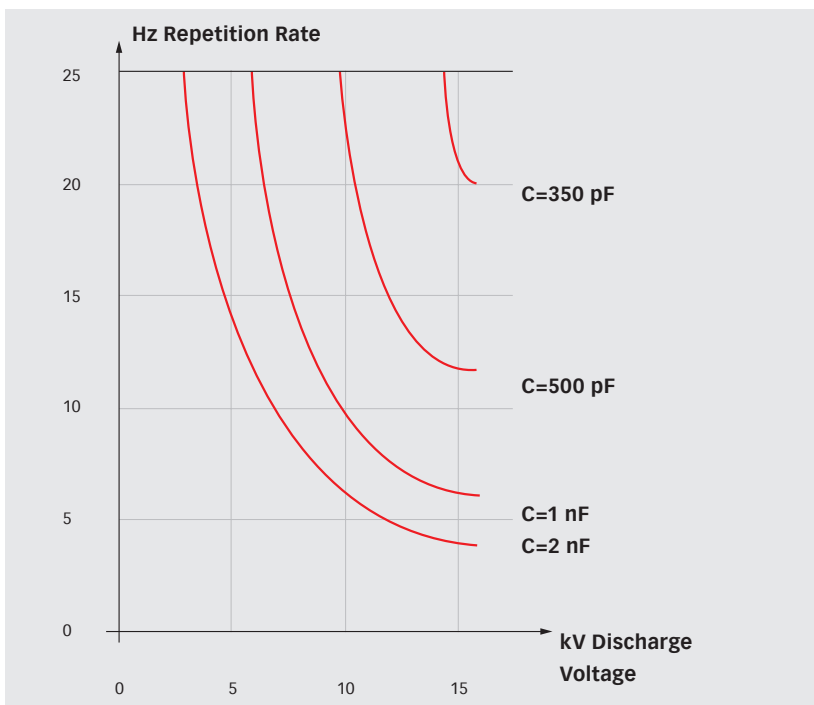

8.4 Repairs

Repair work is to be executed exclusively by authorized Teseq repair departments. Only original replacement parts and accessories are to be used.

Do not continue to use the instrument in the event of mechanical damage occurring. The molded housing also performs insulating and protective functions which are only assured as long as it is in its original condition. A damaged instrument should be returned without delay to a Teseq service centre.

8.5 Disposal

The following list shows the principal materials that are used in the construction of the NSG 435. The relevant national regulations are to be observed when disposing of the instrument.

Item	Material	Remark
Housing	ABS with glass-fiber	
Control unit	Epoxy circuit board with SMD components	
LCD-display	Glass	
LCD-window	Acrylic	
Chassis plate	Galvanized steel	
HV unit/ network	Polyurethane block with electr. components and copper wire	
HV relay	Various metals, ceramic various insulating Magerials	
Test finger	Brass, plastics, electrical components	
Battery	Nickel-metal hybrid (>2002) ABS hosing Epoxy circuit board	Observe any special regulations regarding disposal of Ni-MHS
Charger	ABS housing with transformer, PCB with electr, components	
Carrying case	Polyethylene	

9 DECLARATION OF CONFORMITY CE

51

TESEQ

Advanced Test Solutions for EMC

Teseq AG Nordstrasse 11F, 4542 Luterbach, Switzerland
T +41 32 681 40 40 F +41 32 681 40 48 www.teseq.com

Declaration of conformity



Manufacturer: Teseq AG
Address: Nordstrasse 11F, 4542 Luterbach, Switzerland
declares that the following product
Product: NSG 435 ESD Simulator
Options: all
conforms to the following Directives and Regulations
EMC Directive 2004/108/EEC
LVD Directive 2006/95/EEC
Standards: EN61326-1, 2005
EN61326-2-1, 2005
EN61010-1, 2001
The relevant technical file is available for inspection:
Technical file: N° EMC 435 / LVD 435
Teseq AG
CH - 4542 Luterbach

The purpose of this instrument is the generation of defined interference signals for EMI immunity testing. Depending on the arrangement of the test rig, the configuration, the cabling and the properties of the EUT itself, a significant amount of electromagnetic radiation may result that could also affect other equipment and systems. The user himself or herself is ultimately responsible for the correct and controlled operation of the rig. In case of doubt, the tests should be carried out in a Faraday cage.

European representative: Teseq GmbH, Landsberger Str. 255, 12623 Berlin, Germany
Place and Date: Luterbach, August 27th, 2008

Johannes Schmid
President

TESEQ

Advanced Test Solutions for EMC

10 TECHNICAL SPECIFICATIONS



Description	Compact ESD simulator with microprocessor controller, large surface LC-display, built-in HV-relay for contact-discharges, mains-independent
Pulse data	<ul style="list-style-type: none"> – standard Conforms to IEC/EN 61000-4-2 – special With exchangeable networks/test fingers for other standards
Pulse network	<ul style="list-style-type: none"> – standard 150 pF/330 Ω as per IEC/EN 61000-4-2 – special Exchangeable networks for other standards as accessories <p>Range R = 0 Ω to 10 kΩ Range C = 60 pF to 1000 pF</p>
Discharge voltage (air-discharge)	200 V to 16.5 kV (in 100 V steps) (Tolerance ±5%, 1 to 16 kV)
Discharge voltage (contact-discharge)	200 V to 9 kV (in 100 V steps) (Tolerance ±5%, 1 to 9 kV)
Test finger -standard	Ball and point as per IEC/EN, exchangeable via locking ring
Voltage measurement	On HV-side, dynamic Accuracy better than ±5% (1 kV to 16.5 kV)
Arcing recognition	Indicated also acoustically in the «single» operating mode
Holding time	> 5 s
Charge resistor R _{ch}	50 MΩ
Triggering	Trigger button in handgrip or by remote trigger unit with 5 m (197") optical cable
Power supply	Battery in handgrip, exchangeable, charging time: approx. 3 hours Mains power unit as an accessory

Operation	Via push-buttons and microprocessor
Discharge modes	Air-discharge Contact-discharge
Polarity	Pos., neg. and automatic switch-over
Operating modes	Single Repetitive at 0.5, 1, 5, 10, 20 or 25 Hz Pulse counter 0 to 9999 Preselect counter 0 to 9999 Continuous operation
Discharge voltage	200 V to 16.5 kV (air-discharge) 200 V to 9 kV (contact-discharge) Fixed levels, 4 values each, programmable
Auto-shut-off	After 30 minutes idle time (without loss of the test parameters)
Display	LCD panel showing – Discharge voltage – Breakdown voltage – Polarity – Air- / contact-discharge – Counter / preselect counter content – Soft-key functions – Battery monitor
Weight	NSG 435 with battery: 1.2 kg (2.6 lbs) approx.
Ambient conditions	Operating +5° to +40°C 20 to 80% r.h. (non-condensing) 68 to 106 kPa

11 ESD STANDARDS



Most widely adopted EMC standard for domestic or industrial appliances is the basic immunity standard IEC/EN 61000-4-2, Ed. 1.2:2001.

The following documents are either already identical or compatible to a large extent:

- IEC/EN 61000-4-2, Ed 1.2:2001 (equivalent)
- IEC/EN 61000-4-2 (harmonized)

Many product or product family standards refer back to these documents.

Special discharge networks and test fingers are called for by:

ANSI C63.16	Guide for ESD
ISO 10605:2008	Road Vehicles ESD
SAE J1113, Part 5	Vehicle Component ESD
and others	

12 WARRANTY



During this period, any defective component part will be repaired or replaced free of charge or, if necessary, the instrument will be replaced by another of equivalent value. The decision regarding the method of reinstating the functional capability is at the sole discretion of Teseq.

Excluded from the warranty is damage or consequential damage caused by negligent operation or use as well as the replacement of parts subject to degradation.

The warranty is rendered invalid by any intervention on the part of the customer or a third party.

The goods are to be returned in the original packing or other equivalent packing suitable for the purpose of the foreseen means of transport.

Teseq can accept no responsibility for damage in transit.

13 ORDERING INFORMATION



NSG 435 basic kit consisting of:	Order no.	Qty.
NSG 435 ESD simulator complete with: Carrying case Network for IEC/EN 61000-4-2, Ed. 1.2:2001 with 150 pF/330 Ω Test fingers, ball and point Battery-pack / earth cable / operating instructions charging unit 100/230 V, 50/60 Hz, with interna- tional adapter set	NSG 435

Options	Order no.	Qty.
Mains power supply, 80 to 240 V, 50/60 Hz, incl. grip adapter	INA 402-..*
Spare battery-pack	INA 405
Remote triggering unit, including 5 m opto-cable	INA 415
Networks and test fingers		
ANSI C63, 1991, hand-metal-mod. (180 pF/330 Ω)	INA 422
IEC 801-2: 1984 (150 pF/150 Ω)	INA 421
Special test finger for fast leading edge <400 ps	INA 420
Discharge networks, special versions R and C are to be specifiedpF/....Ω
Measuring adapter IEC/EN 61000-4-2 (IEC 801-2, 1991)	MD 101
ESD target set IEC/EN 61000-4-2, Ed. 1.2:2001	MD 103
Calibration adapter	INA 103

Specify mains cable: -01 = SCHUKO; -02 = SEV 13; -04 = UL 498; -05 = BS 1363

NSG 435 ESD simulator

Headquarters

Teseq AG

4542 Luterbach, Switzerland

T +41 32 681 40 40

F +41 32 681 40 48

sales@teseq.com

www.teseq.com

China

Teseq Company Limited

T +86 10 8460 8080

F +86 10 8460 8078

chinasales@teseq.com

Germany

Teseq GmbH

T +49 30 5659 8835

F +49 30 5659 8834

desales@teseq.com

Singapore

Teseq Pte Ltd.

T +65 6846 2488

F +65 6841 4282

singaporesales@teseq.com

Taiwan

Teseq Ltd.

T +886 2 2917 8080

F +886 2 2917 2626

taiwansales@teseq.com

USA

Teseq Inc.

T +1 732 417 0501

F +1 732 417 0511

Toll free +1 888 417 0501

usasales@teseq.com

To find your local partner within Teseq®'s global network, please go to

www.teseq.com

Manufacturer

Teseq AG

4542 Luterbach, Switzerland

T +41 32 681 40 40

F +41 32 681 40 48

sales@teseq.com

France

Teseq Sarl

T +33 1 39 47 42 21

F +33 1 39 47 40 92

francesales@teseq.com

Japan

Teseq K.K.

T +81 3 5725 9460

F +81 3 5725 9461

japansales@teseq.com

Switzerland

Teseq AG

T +41 32 681 40 50

F +41 32 681 40 48

sales@teseq.com

UK

Teseq Ltd.

T +44 845 074 0660

F +44 845 074 0656

uksales@teseq.com

© June 2012 Teseq®

Specifications subject to change without notice. Teseq® is an ISO-registered company. Its products are designed and manufactured under the strict quality and environmental requirements of the ISO 9001. This document has been carefully checked. However, Teseq® does not assume any liability for errors or inaccuracies.