

# Keysight 2-Port and 4-Port PNA Network Analyzer

N5227B 900 Hz to 67 GHz

Data Sheet and  
Technical  
Specifications

## Documentation Warranty

THE MATERIAL CONTAINED IN THIS DOCUMENT IS PROVIDED "AS IS," AND IS SUBJECT TO BEING CHANGED, WITHOUT NOTICE, IN FUTURE EDITIONS. FURTHER, TO THE MAXIMUM EXTENT PERMITTED BY APPLICABLE LAW, KEYSIGHT DISCLAIMS ALL WARRANTIES, EITHER EXPRESS OR IMPLIED WITH REGARD TO THIS MANUAL AND ANY INFORMATION CONTAINED HEREIN, INCLUDING BUT NOT LIMITED TO THE IMPLIED WARRANTIES OF MERCHANTABILITY AND FITNESS FOR A PARTICULAR PURPOSE. KEYSIGHT SHALL NOT BE LIABLE FOR ERRORS OR FOR INCIDENTAL OR CONSEQUENTIAL DAMAGES IN CONNECTION WITH THE FURNISHING, USE, OR PERFORMANCE OF THIS DOCUMENT OR ANY INFORMATION CONTAINED HEREIN. SHOULD KEYSIGHT AND THE USER HAVE A SEPARATE WRITTEN AGREEMENT WITH WARRANTY TERMS COVERING THE MATERIAL IN THIS DOCUMENT THAT CONFLICT WITH THESE TERMS, THE WARRANTY TERMS IN THE SEPARATE AGREEMENT WILL CONTROL.

## U.S. Government Rights

U.S. Government Rights. The Software is "commercial computer software," as defined by Federal Acquisition Regulation ("FAR") 2.101. Pursuant to FAR 12.212 and 27.405-3 and Department of Defense FAR Supplement ("DFARS") 227.7202, the U.S. government acquires commercial computer software under the same terms by which the software is customarily provided to the public. Accordingly, Keysight provides the Software to U.S. government customers under its standard commercial license, which is embodied in its End User License Agreement (EULA), a copy of which can be found at <http://www.keysight.com/find/sweula>. The license set forth in the EULA represents the exclusive authority by which the U.S. government may use, modify, distribute, or disclose the Software. The EULA and the license set forth therein, does not require or permit, among other things, that Keysight: (1) Furnish technical information related to commercial computer software or commercial computer software documentation that is not customarily provided to the public; or (2) Relinquish to, or otherwise provide, the government rights in excess of these rights customarily provided to the public to use, modify, reproduce, release, perform, display, or disclose commercial computer software or commercial computer software documentation. No additional government requirements beyond those set forth in the EULA shall apply, except to the extent that those terms, rights, or licenses are explicitly required from all providers of commercial computer software pursuant to the FAR and the DFARS and are set forth specifically in writing elsewhere in the EULA. Keysight shall be under no obligation to update, revise or otherwise modify the Software. With respect to any technical data as defined by FAR 2.101, pursuant to FAR 12.211 and 27.404.2 and DFARS 227.7102, the U.S. government acquires no greater than Limited Rights as defined in FAR 27.401 or DFARS 227.7103-5 (c), as applicable in any technical data.

<b>Dynamic Range</b> .....	<b>8</b>
System Dynamic Range .....	9
Table 1a. System Dynamic Range at Test Port (dB), Options 200 or 400.....	9
Table 1b. System Dynamic Range at Test Port (dB), Options 201 or 401 .....	10
Table 1c. System Dynamic Range at Test Port (dB), Options 219 or 419.....	11
Table 1d. System Dynamic Range at Test Port (dB), Option 205, 405 .....	12
Table 1e. System Dynamic Range at Test Port (dB), Option 220, 420.....	13
Table 1f. System Dynamic Range at Test Port (dB), All LFE Options (LFE Enabled) .....	14
Extended Dynamic Range .....	15
Table 2a. Extended Dynamic Range at Direct Receiver Access Input (dB) – Typical .....	15
Table 2b. Extended Dynamic Range at Direct Receiver Access Input (dB), Option 205, 405 – Typical...	16
Table 2c. Extended Dynamic Range at Direct Receiver Access Input (dB), Option 220, 420 – Typical...	17
Receiver Dynamic Range .....	18
Table 3a. Receiver Dynamic Range (dB), All Options .....	18
Table 3b. Receiver Dynamic Range (dB), All Ports, All LFE Options (LFE Enabled) .....	18
<b>Corrected System Performance, All Options</b> .....	<b>19</b>
Table 4a. N5227B with 85058B Calibration Kit .....	19
Table 4b. N5227B with N4694A 2-Port Electronic Calibration Module .....	22
Table 4c. N5227B with N4694D 2-Port Electronic Calibration Module.....	24
Table 4d. N5227B with 85058B Calibration Kit, All LFE Options (LFE Enabled).....	26
Table 4e. N5227B with N4694D Calibration Kit, All LFE Options (LFE Enabled) .....	27
<b>Uncorrected System Performance</b> .....	<b>29</b>
Table 5a. Error Terms (dB), All Ports, All Options - Specifications .....	29
Table 5b. Error Terms (dB), All Ports, All LFE Options (LFE Enabled) - Specifications.....	29
Table 5c. Error Terms (dB), All Ports, All Options - Typical.....	30
Table 5d. Error Terms (dB), All Ports, All LFE Options (LFE Enabled) - Typical.....	30
<b>Test Port Output</b> .....	<b>31</b>
Table 6. Frequency Information, All Options.....	31
Table 7a. Maximum Leveled Power (dBm) – Specification .....	31
Table 7b. Maximum Leveled Power (dBm) – Typical .....	32
Table 7c. Maximum Leveled Power (dBm) – All LFE Options - Specification .....	33
Table 7d. Maximum Leveled Power (dBm) – All LFE Options - Typical .....	34
Table 7e. Maximum Power (dBm), All Ports – All LFE Options (LFE Enabled) .....	35
Table 8a. Power Level Accuracy (dB) at Nominal Power <sup>1</sup> , All Options.....	35
Table 8b. Power Level Accuracy (dB), All Ports, All LFE Options (LFE Enabled) .....	36

Table 9a. Power Level Linearity <sup>1</sup> (dB), All Options - Specification .....	36
Table 9b. Power Level Linearity <sup>1</sup> (dB), All Options - Specification .....	36
Table 9c. Power Level Linearity <sup>1</sup> (dB), All Ports, All LFE Options (LFE Enabled).....	37
Table 10a. Power Sweep Range (dB) - Specification .....	37
Table 10b. Power Sweep Range (dB) - Typical.....	38
Table 10c. Power Sweep Range (dB) - All LFE Options - Specification .....	39
Table 10d. Power Sweep Range (dB) - All LFE Options - Typical.....	40
Table 10e. Power Sweep Range (dB) - All LFE Options (LFE Enabled) .....	41
Table 11. Nominal (Preset) Power (dBm).....	41
Table 12. Power Resolution and Maximum/Minimum Settable Power, All Models and Options .....	41
Table 13a. 2 <sup>nd</sup> and 3 <sup>rd</sup> Harmonics at Max Specified Power (dBc) All Options - Typical.....	41
Table 13b. 2 <sup>nd</sup> and 3 <sup>rd</sup> Harmonics at Max Specified Power (dBc), All Ports, All LFE Options (LFE Enabled) - Typical.....	42
Table 14. Non-Harmonic Spurs at Nominal Power (dBc), All Options - Typical.....	42
Table 15a. Phase Noise (dBc/Hz), All Options - Typical.....	43
Table 15b. Phase Noise (dBc/Hz), All Ports, All LFE Options (LFE Enabled) - Typical .....	43
<b>Test Port Input .....</b>	<b>44</b>
Table 16a. Test Port Noise Floor (dBm) @ 10 Hz IFBW, All Options .....	44
Table 16b. Test Port Noise Floor (dBm) @ 10 Hz IFBW, All LFE Options (LFE Enabled).....	44
Table 17. Direct Receiver Access Input Noise Floor (dBm) .....	45
Table 18a. 0.1 dB Compression, Option 201, 219, 401, 419, and All LFE Options - Typical.....	46
Table 18b. 0.1 dB Compression, All Ports, All LFE Options (LFE Enabled) - Typical.....	46
Table 18c. Compression - Specification .....	47
Table 18d. Compression, All Ports, All LFE Options (LFE Enabled) - Specification.....	47
Table 19a. Trace Noise <sup>2</sup> Magnitude (dB rms), All Options.....	48
Table 19b. Trace Noise <sup>1</sup> Magnitude (dB rms), All Ports, All LFE Options (LFE Enabled) .....	48
Table 20a. Trace Noise <sup>2</sup> Phase (deg rms), All Options.....	49
Table 20b. Trace Noise <sup>1</sup> Phase (deg rms), All Ports, All LFE Options (LFE Enabled) .....	49
Table 21. Reference Level Magnitude, All Models and Options - Specification .....	49
Table 22a. Stability, All Options - Typical.....	50
Table 22b. Stability <sup>1</sup> , All LFE Options (LFE Enabled) - Typical.....	50
Table 23. Damage Input Level, All Options.....	50
<b>Dynamic Accuracy .....</b>	<b>51</b>
Table 24. N5227B Dynamic Accuracy.....	51
Table 25. Group Delay - Typical.....	57

<b>General Information</b> .....	<b>58</b>
Table 26. Miscellaneous Information .....	58
Table 27. Front Panel Information, All Options.....	58
Table 27. (Continued) Front Panel Information, All Options.....	59
Table 28. Rear Panel Information, All Options.....	59
Table 28. (Continued) Rear Panel Information, All Options.....	60
Table 28. (Continued) Rear Panel Information, All Options.....	61
Table 28. (Continued) Rear Panel Information, All Options.....	62
Table 29. Analyzer Dimensions and Weight .....	63
Regulatory and Environmental Information .....	63
<b>Measurement Throughput Summary</b> .....	<b>64</b>
Table 30. Typical Cycle Time (ms) for Measurement Completion, All Models and Options .....	64
Table 31. Typical Cycle Time (ms) for Full-Span Measurement Completion .....	65
Table 32. Cycle Time vs. IF Bandwidth - Typical .....	65
Table 33. Cycle Time vs. Number of Points - Typical .....	66
Table 34. Data Transfer Time (ms) - Typical.....	67
<b>Specifications: Front-Panel Jumpers</b> .....	<b>68</b>
Table 35. Measurement Receiver Inputs (dBm) - Typical.....	68
Table 36. Port 1 Reference Receiver Inputs and Reference Source Outputs (dBm) - Typical .....	69
Table 37. Port 2, 3, 4 Reference Receiver Inputs and Reference Source Outputs (dBm) - Typical .....	70
Table 38. Source Outputs (dBm) - Typical.....	71
Table 39. Coupler Inputs (dB) - Typical .....	72
Table 40. Damage Level, All Options - Typical .....	72
<b>Test Set Block Diagrams</b> .....	<b>73</b>
N5227B Option 200 (2-port base model) .....	73
N5227B Option 201 .....	74
N5227B LFE Options .....	74
N5227B Option 219.....	75
N5227B Option 400 (4-port base model) .....	75
N5227B Option 401 .....	76
N5227B Option 419.....	76
Receiver Block Diagram .....	77

This is a complete list of the technical specifications for the N5227B PNA network analyzer with the following options. See block diagrams for all models and options beginning on page 60.

## 2-Port Models

**Option 200** - 2-port base model with standard test set.

**Option 201** - To base model, adds front-panel jumpers and R1 receiver switch.

**Option 219** - To base model, adds front-panel jumpers, R1 receiver switch, source and receiver attenuators (extended power range), and bias-tees.

## 4-Port Models

**Option 400** - 4-port base model with standard test set.

**Option 401** - To base model, adds front-panel jumpers and R1 receiver switch.

**Option 419** - To base model, adds front-panel jumpers, R1 receiver switch, source and receiver attenuators (extended power range), and bias-tees.

## Low Frequency Extension (LFE) Options

Option	Description
<b>2-Port Model</b>	
205	2-port standard test set (includes six front-panel access loops), R1 receiver switch, and low frequency extension (LFE) hardware.  2-port standard test set (includes six front-panel access loops), R1 receiver switch, source and receiver attenuators (extended power range), bias-tees, and low frequency extension (LFE) hardware.
<b>4-Port Model</b>	
405	4-port standard test set (includes six front-panel access loops), R1 receiver switch, and low frequency extension (LFE) hardware.
420	4-port standard test set (includes six front-panel access loops), R1 receiver switch, source and receiver attenuators (extended power range), bias-tees, and low frequency extension (LFE) hardware.

## Notes

This document provides technical specifications for the 85058B calibration kit and N4694A ECal module.

Please download our free Uncertainty Calculator from [http://www.keysight.com/find/na\\_calculator](http://www.keysight.com/find/na_calculator) to generate the curves for your calibration kit and PNA setup.

Typical performance information between 67 GHz and 70 GHz is shown in this document where available. The performance is degraded at particular frequencies in this range due to the modes of the 1.85 mm connectors used in the analyzer, test port cables and adapters.

For all tables in this data sheet, the specified performance at the exact frequency of a break is the degraded value of the two specifications at that frequency.

## Definitions

All specifications and characteristics apply over a  $25\text{ }^{\circ}\text{C} \pm 5\text{ }^{\circ}\text{C}$  range (unless otherwise stated) and 90 minutes after the instrument has been turned on.

**Specification (spec.):** Warranted performance. Specifications include guardbands to account for the expected statistical performance distribution, measurement uncertainties, and changes in performance due to environmental conditions.

**Characteristic (char.):** A performance parameter that the product is expected to meet before it leaves the factory, but that is not verified in the field and is not covered by the product warranty. A characteristic includes the same guardbands as a specification.

**Typical (typ.):** Expected performance of an average unit which does not include guardbands. It is not covered by the product warranty.

**Nominal (nom.):** A general, descriptive term that does not imply a level of performance. It is not covered by the product warranty.

**Calibration:** The process of measuring known standards to characterize a network analyzer's systematic (repeatable) errors.

**Corrected (residual):** Indicates performance after error correction (calibration). It is determined by the quality of calibration standards and how well "known" they are, plus system repeatability, stability, and noise.

**Uncorrected (raw):** Indicates instrument performance without error correction. The uncorrected performance affects the stability of a calibration.

**Standard:** When referring to the analyzer, this includes no options unless noted otherwise.

**Standard and LFE measurements:** With an LFE option, which adds low frequency extension (LFE) hardware, the LFE measurement range overlaps with the standard measurement range from 10 MHz to 100 MHz. With LFE Enabled, measurements from 500 Hz to 100 MHz use LFE hardware. With LFE Disabled, measurements from 10 MHz to 100 MHz use standard hardware. To measure below 10 MHz, LFE must be enabled. All measurements above 100 MHz use standard hardware, regardless of the LFE Enabled/Disabled setting.

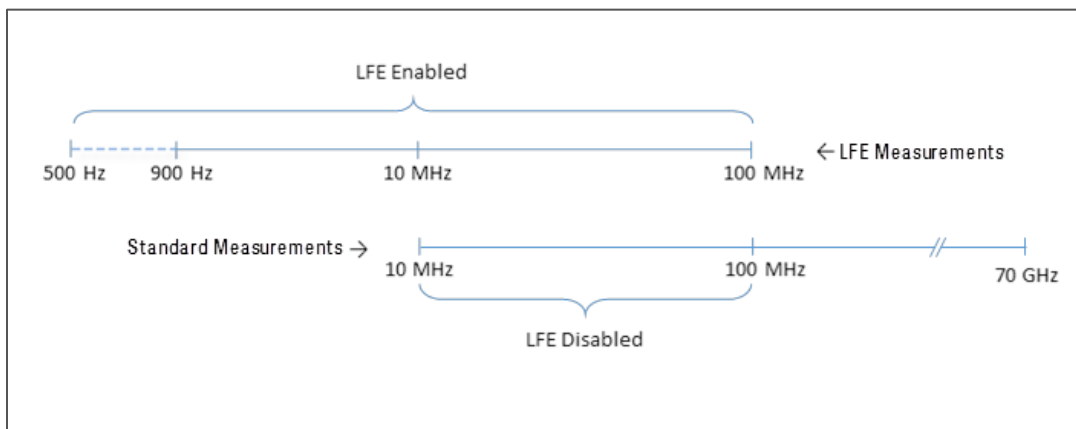

## Dynamic Range

The specifications in this section apply for measurements made with the N5227B PNA network analyzer with the following conditions:

- 10 Hz IF bandwidth
- No averaging applied to data
- Isolation calibration with an averaging factor of 8
- **System Dynamic Range** is defined as the measured source maximum output power (A) minus the measured noise floor (B).
- **Extended Dynamic Range at Direct Access Input** is defined as the system dynamic range (typical) less the nominal loss associated with the test port coupler.
- **Receiver Dynamic Range** is defined as the typical test port 0.1 dB compression (C) minus the typical noise floor (D).

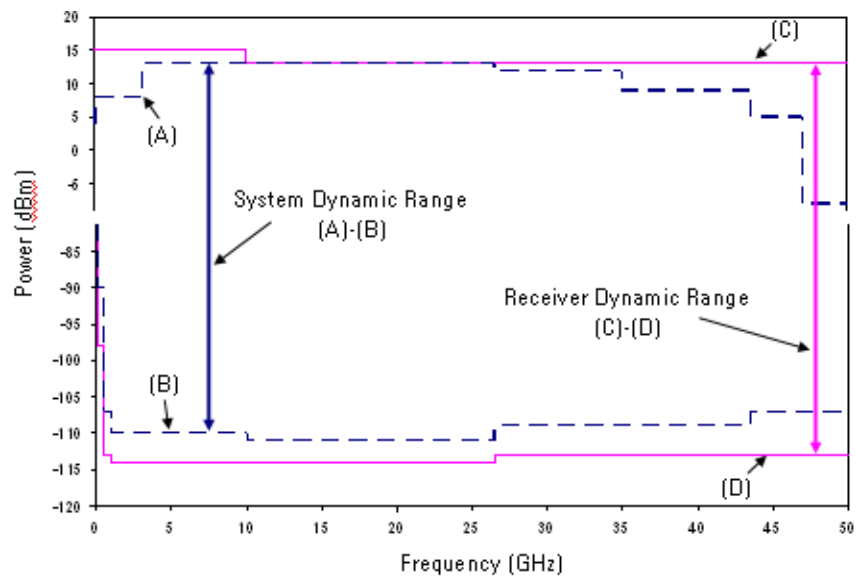



## System Dynamic Range

Table 1a. System Dynamic Range at Test Port (dB), Options 200 or 400

Description	Specification		Typical	
	Ports <sup>1</sup> 1, 3	Ports <sup>1</sup> 2, 4	Ports <sup>1</sup> 1, 3	Ports <sup>1</sup> 2, 4
10 MHz to 50 MHz	87	86	95	95
50 MHz to 100 MHz	107	108	116	117
100 MHz to 500 MHz	116	115	129	131
500 MHz to 1 GHz	127	129	135	137
1 GHz to 2 GHz	130	133	138	141
2 GHz to 3.2 GHz	127	130	134	139
3.2 GHz to 10 GHz	130	132	138	140
10 GHz to 13.5 GHz	131	130	139	139
13.5 GHz to 16 GHz	130	131	138	140
16 GHz to 19 GHz	129	129	138	138
19 GHz to 20 GHz	130	130	138	139
20 GHz to 24 GHz	130	130	138	138
24 GHz to 26.5 GHz	130	130	138	138
26.5 GHz to 30 GHz	122	120	131	129
30 GHz to 32 GHz	120	118	129	127
32 GHz to 35 GHz	121	118	129	127
35 GHz to 40 GHz	110	108	121	119
40 GHz to 43.5 GHz	116	111	127	121
43.5 GHz to 50 GHz	118	114	127	124
50 GHz to 60 GHz	116	112	126	122
60 GHz to 64 GHz	118	114	127	123
64 GHz to 67 GHz	118	114	128	125
67 GHz to 70 GHz	--	--	126	123

<sup>1</sup> Either port can be used as the source port. Any other port can be used as the receiver port.

Table 1b. System Dynamic Range at Test Port (dB), Options 201 or 401

Description	Specification		Typical	
	Ports <sup>1</sup> 1, 3	Ports <sup>1</sup> 2, 4	Ports <sup>1</sup> 1, 3	Ports <sup>1</sup> 2, 4
10 MHz to 50 MHz	87	85	96	94
50 MHz to 100 MHz	109	107	117	116
100 MHz to 500 MHz	116	115	130	130
500 MHz to 1 GHz	128	128	136	137
1 GHz to 2 GHz	131	132	138	140
2 GHz to 3.2 GHz	128	131	135	139
3.2 GHz to 10 GHz	130	132	137	139
10 GHz to 13.5 GHz	132	130	139	138
13.5 GHz to 16 GHz	130	129	138	138
16 GHz to 19 GHz	130	130	139	138
19 GHz to 20 GHz	130	130	139	139
20 GHz to 24 GHz	130	130	138	138
24 GHz to 26.5 GHz	129	129	137	137
26.5 GHz to 30 GHz	122	121	131	130
30 GHz to 32 GHz	119	120	128	128
32 GHz to 35 GHz	120	119	128	128
35 GHz to 40 GHz	111	111	121	121
40 GHz to 43.5 GHz	115	114	125	123
43.5 GHz to 50 GHz	115	115	125	125
50 GHz to 60 GHz	115	114	124	124
60 GHz to 64 GHz	117	115	125	125
64 GHz to 67 GHz	118	117	127	127
67 GHz to 70 GHz	--	--	124	124

<sup>1</sup> Either port can be used as the source port. Any other port can be used as the receiver port.

Table 1c. System Dynamic Range at Test Port (dB), Options 219 or 419

Description	Specification		Typical	
	Ports <sup>1</sup> 1, 3	Ports <sup>1</sup> 2, 4	Ports <sup>1</sup> 1, 3	Ports <sup>1</sup> 2, 4
10 MHz to 50 MHz	86	86	95	94
50 MHz to 100 MHz	109	108	116	116
100 MHz to 500 MHz	116	116	130	131
500 MHz to 1 GHz	129	129	136	137
1 GHz to 2 GHz	130	133	138	140
2 GHz to 3.2 GHz	126	131	134	138
3.2 GHz to 10 GHz	130	131	137	138
10 GHz to 13.5 GHz	130	129	138	137
13.5 GHz to 16 GHz	130	129	137	137
16 GHz to 19 GHz	128	127	136	136
19 GHz to 20 GHz	128	127	136	136
20 GHz to 24 GHz	127	127	135	135
24 GHz to 26.5 GHz	127	127	135	134
26.5 GHz to 30 GHz	118	118	127	126
30 GHz to 32 GHz	116	116	125	125
32 GHz to 35 GHz	116	115	125	124
35 GHz to 40 GHz	106	106	116	116
40 GHz to 43.5 GHz	111	109	121	118
43.5 GHz to 50 GHz	111	110	120	120
50 GHz to 60 GHz	109	107	118	117
60 GHz to 64 GHz	110	108	119	118
64 GHz to 67 GHz	110	109	119	119
67 GHz to 70 GHz	--	--	116	115

<sup>1</sup> Either port can be used as the source port. Any other port can be used as the receiver port.

Table 1d. System Dynamic Range at Test Port (dB), Option 205, 405

Description	Specification		Typical	
	Ports <sup>2</sup> 1, 3	Ports <sup>2</sup> 2, 4	Ports <sup>2</sup> 1, 3	Ports <sup>2</sup> 2, 4
10 MHz to 50 MHz <sup>1</sup>	81	76	89	87
50 MHz to 100 MHz <sup>1</sup>	103	104	112	113
100 MHz to 500 MHz	110	112	125	126
500 MHz to 1 GHz	123	123	132	133
1 GHz to 2 GHz	130	129	137	139
2 GHz to 3.2 GHz	127	129	134	137
3.2 GHz to 10 GHz	128	128	136	137
10 GHz to 13.5 GHz	128	126	137	136
13.5 GHz to 16 GHz	128	127	137	136
16 GHz to 19 GHz	126	127	136	137
19 GHz to 20 GHz	128	128	137	137
20 GHz to 24 GHz	126	127	135	136
24 GHz to 26.5 GHz	127	127	135	136
26.5 GHz to 30 GHz	118	118	128	128
30 GHz to 32 GHz	116	117	126	126
32 GHz to 35 GHz	117	117	126	127
35 GHz to 40 GHz	107	107	119	119
40 GHz to 43.5 GHz	112	111	123	123
43.5 GHz to 50 GHz	112	113	123	124
50 GHz to 60 GHz	111	111	121	121
60 GHz to 64 GHz	111	112	122	122
64 GHz to 67 GHz	110	114	122	124
67 GHz to 70 GHz	--	--	119	119

<sup>1</sup> With Option 205, 405 installed and LFE disabled, applied to frequencies <= 100 MHz. Above 100 MHz, performance is the same for both LFE enabled or disabled.

<sup>2</sup> Either port can be used as the source port. Any other port can be used as the receiver port.

Table 1e. System Dynamic Range at Test Port (dB), Option 220, 420

Description	Specification		Typical	
	Ports <sup>2</sup> 1, 3	Ports <sup>2</sup> 2, 4	Ports <sup>2</sup> 1, 3	Ports <sup>2</sup> 2, 4
10 MHz to 50 MHz <sup>1</sup>	79	79	88	87
50 MHz to 100 MHz <sup>1</sup>	105	104	112	112
100 MHz to 500 MHz	112	112	126	127
500 MHz to 1 GHz	126	126	133	134
1 GHz to 2 GHz	127	130	135	137
2 GHz to 3.2 GHz	123	128	131	135
3.2 GHz to 10 GHz	128	129	135	136
10 GHz to 13.5 GHz	128	127	136	135
13.5 GHz to 16 GHz	128	127	135	135
16 GHz to 19 GHz	126	125	134	134
19 GHz to 20 GHz	126	125	134	134
20 GHz to 24 GHz	125	125	133	133
24 GHz to 26.5 GHz	125	125	133	132
26.5 GHz to 30 GHz	117	117	126	125
30 GHz to 32 GHz	115	115	124	124
32 GHz to 35 GHz	115	114	124	123
35 GHz to 40 GHz	105	105	115	115
40 GHz to 43.5 GHz	110	108	120	117
43.5 GHz to 50 GHz	110	109	119	119
50 GHz to 60 GHz	108	106	117	116
60 GHz to 64 GHz	109	107	118	117
64 GHz to 67 GHz	109	108	118	118
67 GHz to 70 GHz	--	--	115	114

<sup>1</sup> With Option 220, 420 installed and LFE disabled, applied to frequencies <= 100 MHz. Above 100 MHz, performance is the same for both LFE enabled or disabled.

<sup>2</sup> Either port can be used as the source port. Any other port can be used as the receiver port.

Table 1f. System Dynamic Range at Test Port (dB), All LFE Options (LFE Enabled)

Description	Specification		Typical	
	Ports 1, 3	Ports 2, 4	Ports 1, 3	Ports 2, 4
500 Hz to 900 Hz	--	--	105	105
900 Hz to 1 kHz	100	102	109	110
1 kHz to 10 kHz	103	105	110	111
10 kHz to 100 kHz	113	115	120	121
100 kHz to 1 MHz	120	121	124	125
1 MHz to 5 MHz	121	122	126	127
5 MHz to 10 MHz	112	114	118	119
10 MHz to 50 MHz	110	112	116	117
50 MHz to 100 MHz	110	112	116	117

## Extended Dynamic Range

Table 2a. Extended Dynamic Range at Direct Receiver Access Input (dB) – Typical

Description	Option 201, 401		Option 219, 419	
	Ports <sup>1</sup> 1, 3	Ports <sup>1</sup> 2, 4	Ports <sup>1</sup> 1, 3	Ports <sup>1</sup> 2, 4
10 MHz to 50 MHz	136	134	135	134
50 MHz to 100 MHz	145	144	144	144
100 MHz to 500 MHz	158	158	158	159
500 MHz to 1 GHz	164	165	164	165
1 GHz to 2 GHz	153	155	153	155
2 GHz to 3.2 GHz	150	154	149	153
3.2 GHz to 10 GHz	152	154	152	153
10 GHz to 13.5 GHz	153	152	152	151
13.5 GHz to 16 GHz	152	152	151	151
16 GHz to 19 GHz	153	152	150	150
19 GHz to 20 GHz	153	153	150	150
20 GHz to 24 GHz	152	152	149	149
24 GHz to 26.5 GHz	151	151	149	148
26.5 GHz to 30 GHz	145	144	141	140
30 GHz to 32 GHz	142	142	139	139
32 GHz to 35 GHz	142	142	139	138
35 GHz to 40 GHz	135	135	130	130
40 GHz to 43.5 GHz	138	136	134	131
43.5 GHz to 50 GHz	138	138	133	133
50 GHz to 60 GHz	136	136	130	129
60 GHz to 64 GHz	136	136	130	129
64 GHz to 67 GHz	138	138	130	130
67 GHz to 70 GHz	135	135	127	126

<sup>1</sup> Either port can be used as the source port. Any other port can be used as the receiver port.

Table 2b. Extended Dynamic Range at Direct Receiver Access Input (dB), Option 205, 405 – Typical

Description	Option 205, 405	
	Ports <sup>1</sup> 1, 3	Ports <sup>1</sup> 2, 4
10 MHz to 50 MHz	129	127
50 MHz to 100 MHz	140	141
100 MHz to 500 MHz	153	154
500 MHz to 1 GHz	160	161
1 GHz to 2 GHz	152	154
2 GHz to 3.2 GHz	149	152
3.2 GHz to 10 GHz	151	152
10 GHz to 13.5 GHz	151	150
13.5 GHz to 16 GHz	151	150
16 GHz to 19 GHz	150	151
19 GHz to 20 GHz	151	151
20 GHz to 24 GHz	149	150
24 GHz to 26.5 GHz	149	150
26.5 GHz to 30 GHz	142	142
30 GHz to 32 GHz	140	140
32 GHz to 35 GHz	140	141
35 GHz to 40 GHz	133	133
40 GHz to 43.5 GHz	136	136
43.5 GHz to 50 GHz	136	137
50 GHz to 60 GHz	133	133
60 GHz to 64 GHz	133	133
64 GHz to 67 GHz	133	135
67 GHz to 70 GHz	130	130

<sup>1</sup> Either port can be used as the source port. Any other port can be used as the receiver port.



Table 2c. Extended Dynamic Range at Direct Receiver Access Input (dB), Option 220, 420 – Typical

Description	Option 220, 420	
	Ports <sup>1</sup> 1, 3	Ports <sup>1</sup> 2, 4
10 MHz to 50 MHz	128	127
50 MHz to 100 MHz	140	140
100 MHz to 500 MHz	154	155
500 MHz to 1 GHz	161	162
1 GHz to 2 GHz	150	152
2 GHz to 3.2 GHz	146	150
3.2 GHz to 10 GHz	150	151
10 GHz to 13.5 GHz	150	149
13.5 GHz to 16 GHz	149	149
16 GHz to 19 GHz	148	148
19 GHz to 20 GHz	148	148
20 GHz to 24 GHz	147	147
24 GHz to 26.5 GHz	147	146
26.5 GHz to 30 GHz	140	139
30 GHz to 32 GHz	138	138
32 GHz to 35 GHz	138	137
35 GHz to 40 GHz	129	129
40 GHz to 43.5 GHz	133	130
43.5 GHz to 50 GHz	132	132
50 GHz to 60 GHz	129	128
60 GHz to 64 GHz	129	128
64 GHz to 67 GHz	129	129
67 GHz to 70 GHz	126	125

<sup>1</sup> Either port can be used as the source port. Any other port can be used as the receiver port.

## Receiver Dynamic Range

Table 3a. Receiver Dynamic Range (dB), All Options

Description	Typical
10 MHz to 50 MHz <sup>1</sup>	91
50 MHz to 100 MHz <sup>1</sup>	112
100 MHz to 500 MHz	118
500 MHz to 1 GHz	127
1 GHz to 10 GHz	131
10 GHz to 13.5 GHz	132
13.5 GHz to 26.5 GHz	133
26.5 GHz to 30 GHz	124
30 GHz to 35 GHz	123
35 GHz to 40 GHz	121
40 GHz to 50 GHz	119
50 GHz to 60 GHz	118
60 GHz to 67 GHz	119
67 GHz to 70 GHz	117

<sup>1</sup> With an LFE option installed and LFE disabled, applied to frequencies  $\leq 100$  MHz. Above 100 MHz, performance is the same for both LFE enabled or disabled.

Table 3b. Receiver Dynamic Range (dB), All Ports, All LFE Options (LFE Enabled)

Description	Typical
500 Hz to 900 Hz	106
900 Hz to 1 kHz	109
1 kHz to 10 kHz	109
10 kHz to 100 kHz	118
100 kHz to 1 MHz	123
1 MHz to 5 MHz	123
5 MHz to 10 MHz	119
10 MHz to 50 MHz	120
50 MHz to 100 MHz	120

## Corrected System Performance, All Options

For any  $S_{ii}$  reflection measurement:

- $S_{jj} = 0$ .

For any  $S_{ij}$  transmission measurement:

- $S_{ji} = S_{ij}$  when  $S_{ij} \leq 1$
- $S_{ji} = 1/S_{ij}$  when  $S_{ij} > 1$
- $S_{kk} = 0$  for all  $k$

Applies to the N5227B Option 200, 201, 205, 219, 220, 400, 405, 401, or 419, 420 analyzers, N4697F flexible test port cable set, and a full 2-port calibration. Also applies to the following condition:

Environmental temperature  $23^\circ \pm 3^\circ \text{C}$ , with  $< 1^\circ \text{C}$  deviation from calibration temperature

Table 4a. N5227B with 85058B Calibration Kit

Description	Specification (dB)							
	10 MHz to 50 MHz <sup>1</sup>	50 MHz to 2 GHz <sup>1</sup>	2 GHz to 10 GHz	10 GHz to 20 GHz	20 GHz to 35 GHz	35 GHz to 50 GHz	50 GHz to 60 GHz	60 GHz to 67 GHz
Directivity	35	35	38	38	37	37	34	34
Source Match	34	34	40	40	41	42	40	40
Load Match	34	35	37	37	36	36	33	33
Reflection Tracking								
Mag	0.019	0.019	0.033	0.033	0.033	0.020	0.030	0.030
Phase (°)	0.125	0.125	0.218	0.218	0.218	0.132	0.198	0.198
Transmission Tracking								
Mag	0.159	0.128	0.099	0.094	0.100	0.093	0.121	0.137
Phase (°)	1.047	0.845	0.655	0.619	0.663	0.616	0.801	0.903

<sup>1</sup> With an LFE option installed and LFE disabled, applied to frequencies  $\leq 100$  MHz. Above 100 MHz, performance is the same for both LFE enabled or disabled.

# Transmission Uncertainty, All Options

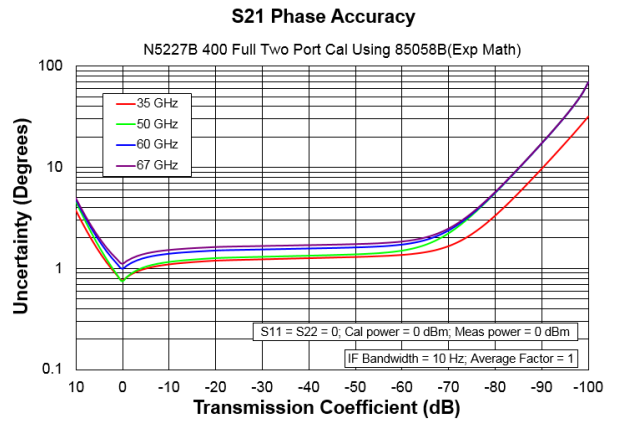
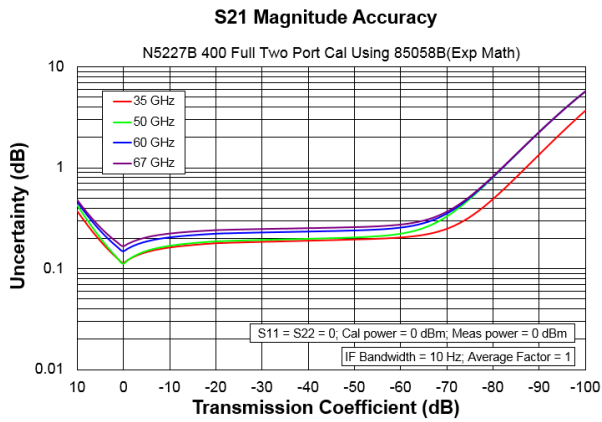
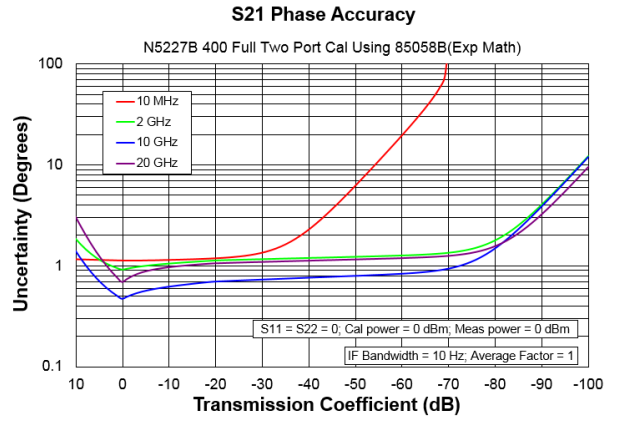
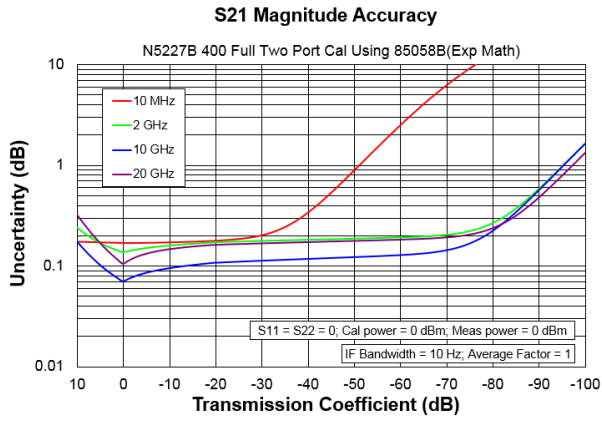

# Reflection Uncertainty, All Options

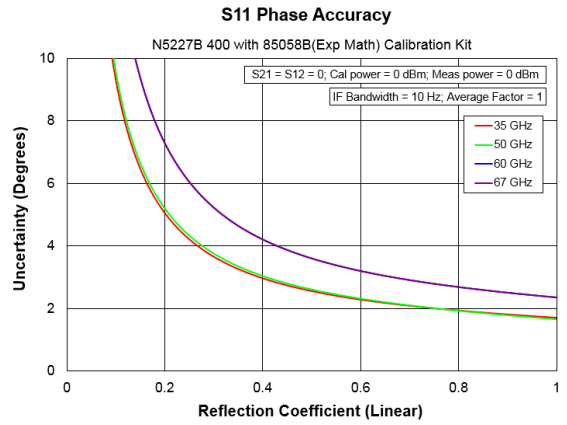
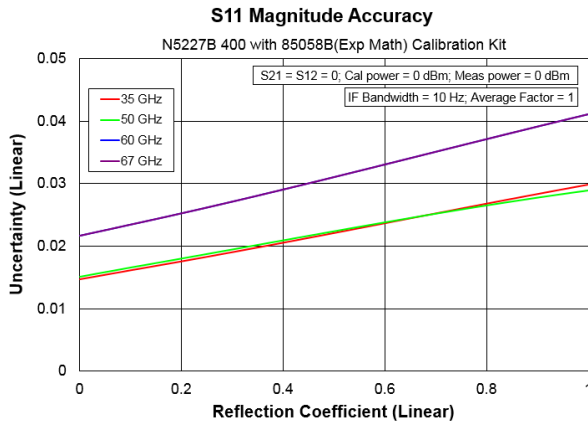
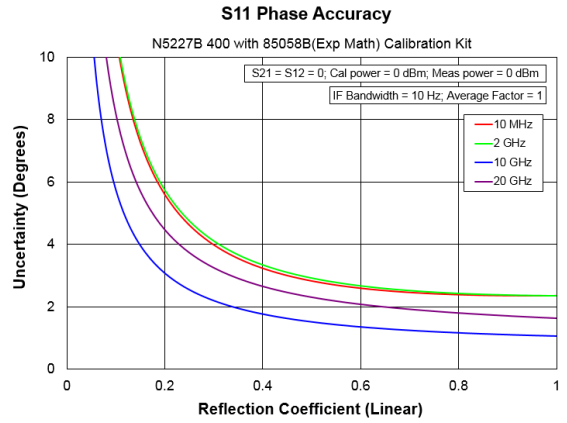
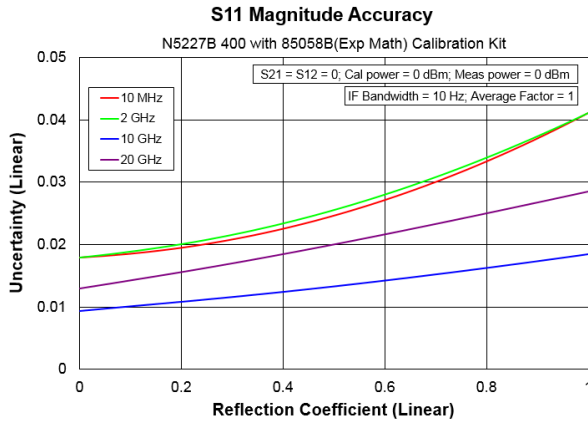
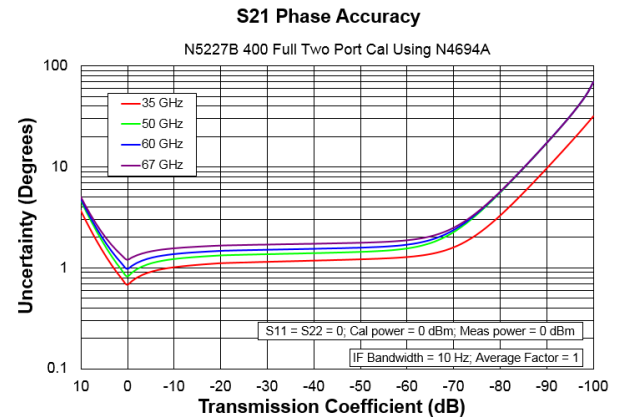
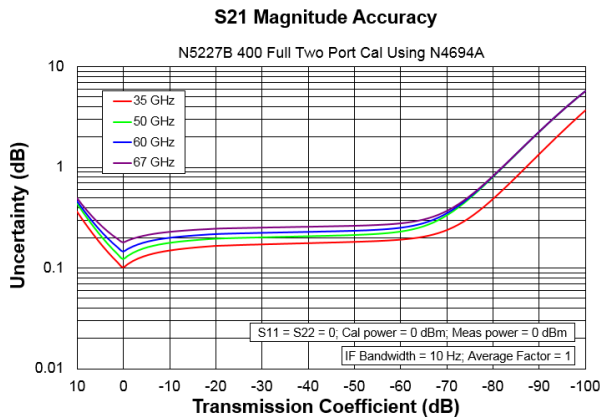
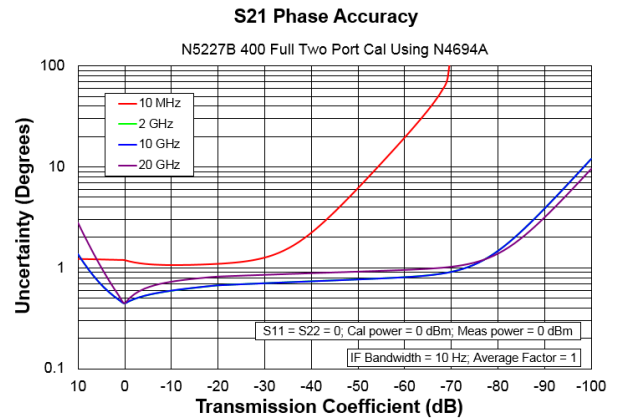
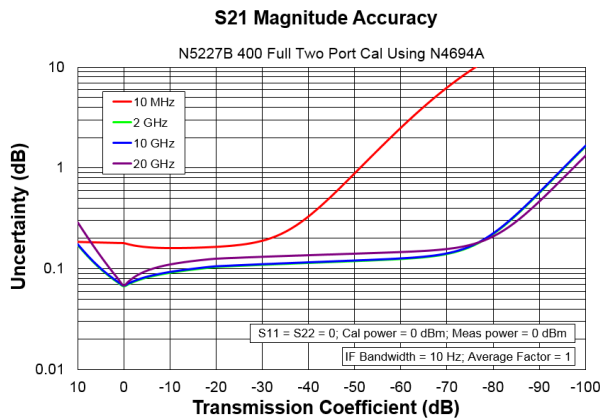

Table 4b. N5227B with N4694A 2-Port Electronic Calibration Module

Description	Specification (dB)							
	10 MHz to 50 MHz <sup>1</sup>	50 MHz to 2 GHz <sup>1</sup>	2 GHz to 20 GHz	20 GHz to 30 GHz	30 GHz to 40 GHz	40 GHz to 50 GHz	50 GHz to 60 GHz	60 GHz to 67 GHz
Directivity	33	41	47	46	44	42	41	38
Source Match	25	38	39	35	34	33	30	27
Load Match	25	37	38	34	33	32	29	26
Reflection Tracking Mag	±0.050	±0.040	±0.040	±0.050	±0.060	±0.070	±0.080	±0.090
Phase (°)	±0.330	±0.264	±0.264	±0.330	±0.396	±0.462	±0.528	±0.594
Transmission Tracking Mag	±0.146	±0.059	±0.057	±0.072	±0.087	±0.104	±0.114	±0.144
Phase (°)	±0.966	±0.392	±0.378	±0.473	±0.576	±0.688	±0.754	±0.951

<sup>1</sup> With Option 205 installed and LFE disabled, applied to frequencies <= 100 MHz. Above 100 MHz, performance is the same for both LFE enabled or disabled.

### Transmission Uncertainty, All Options



# Reflection Uncertainty, All Options

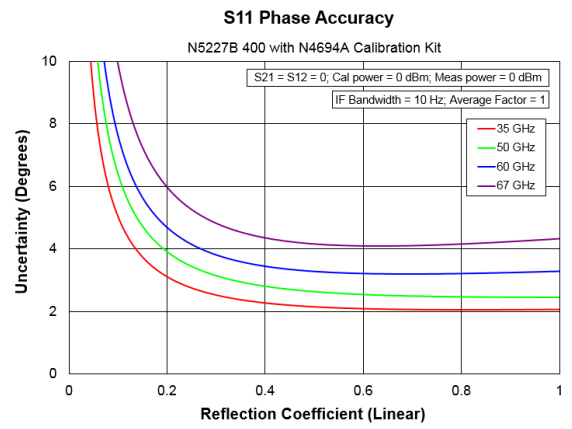
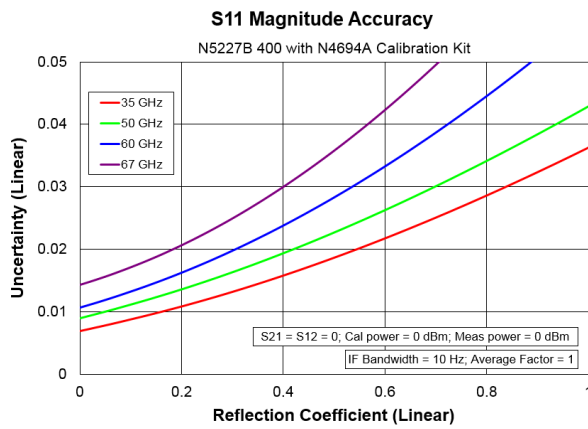
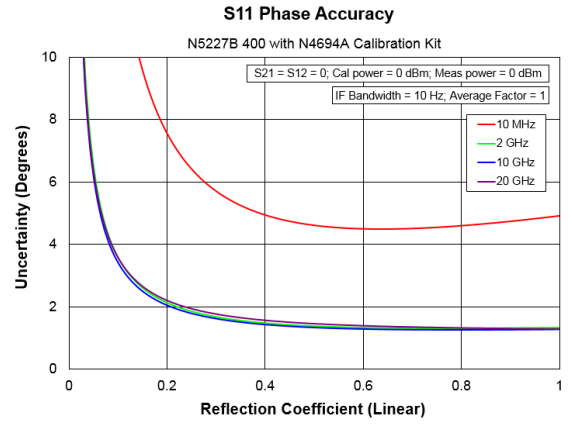
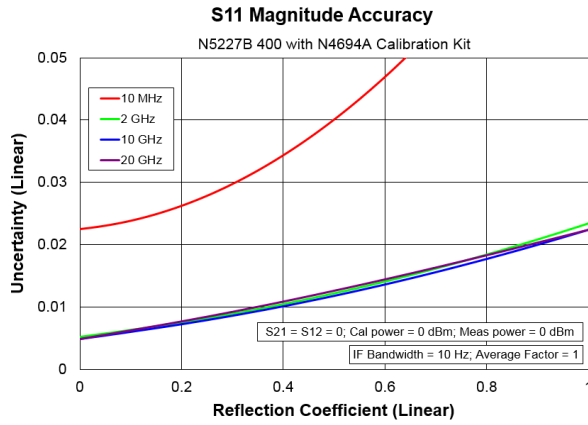
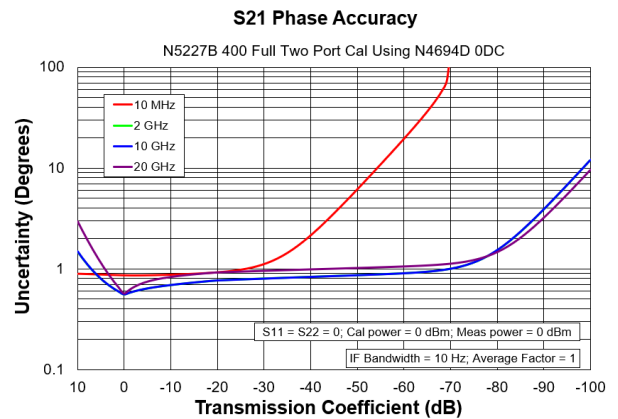
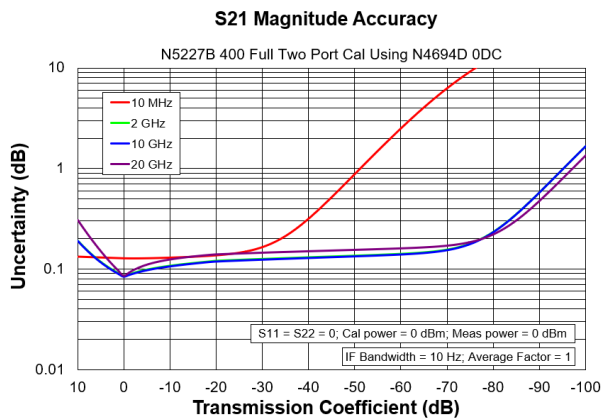

Table 4c. N5227B with N4694D 2-Port Electronic Calibration Module

Description	Specification (dB)							
	10 MHz to 50 MHz <sup>1</sup>	50 MHz to 2 GHz <sup>1</sup>	2 GHz to 20 GHz	20 GHz to 30 GHz	30 GHz to 40 GHz	40 GHz to 50 GHz	50 GHz to 60 GHz	60 GHz to 67 GHz
Directivity	41	41	42	41	40	38	35	33
Source Match	38	38	39	35	34	33	30	26
Load Match	35	36	37	33	32	31	28	24
Reflection								
Tracking Mag	±0.081	±0.041	±0.041	±0.051	±0.061	±0.081	±0.081	±0.13
Phase (°)	±0.54	±0.27	±0.27	±0.34	±0.40	±0.54	±0.54	±0.80
Transmission								
Tracking Mag	±0.12	±0.075	±0.075	±0.089	±0.11	±0.14	±0.15	±0.22
Phase (°)	±0.79	±0.50	±0.50	±0.59	±0.69	±0.90	±0.99	±1.5

<sup>1</sup> With an LFE option installed and LFE disabled, applied to frequencies <= 100 MHz. Above 100 MHz, performance is the same for both LFE enabled or disabled.

### Transmission Uncertainty, All Options





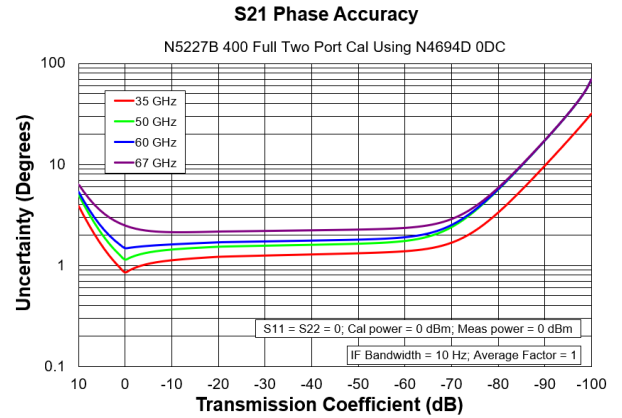
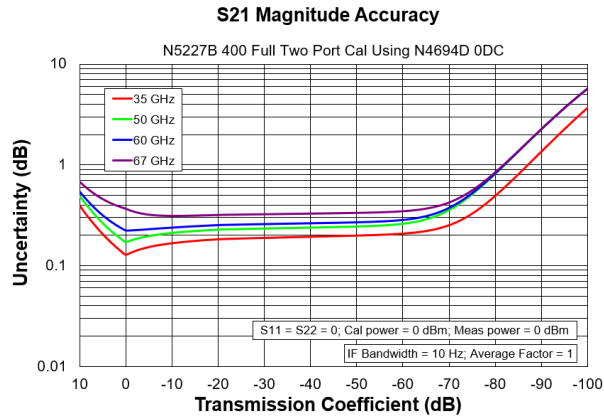

## Reflection Uncertainty, All Options

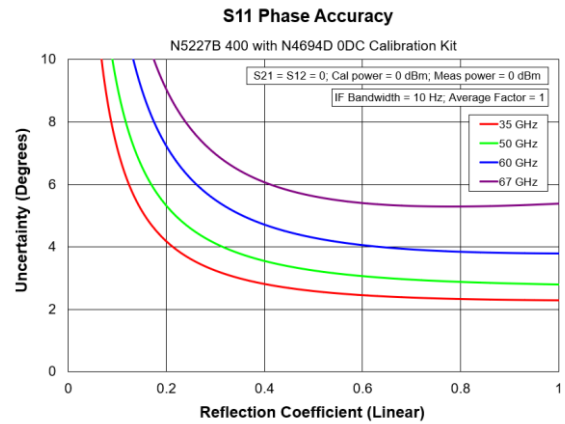
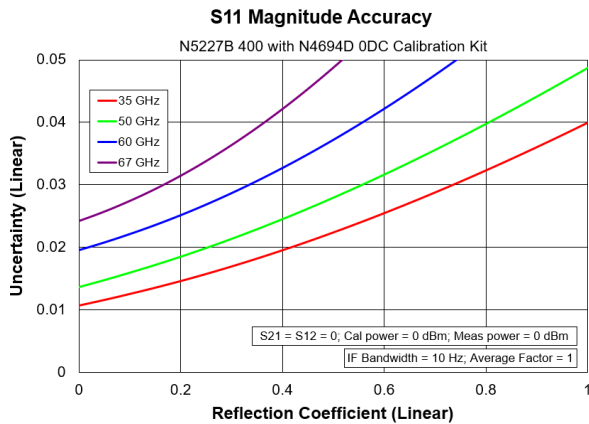
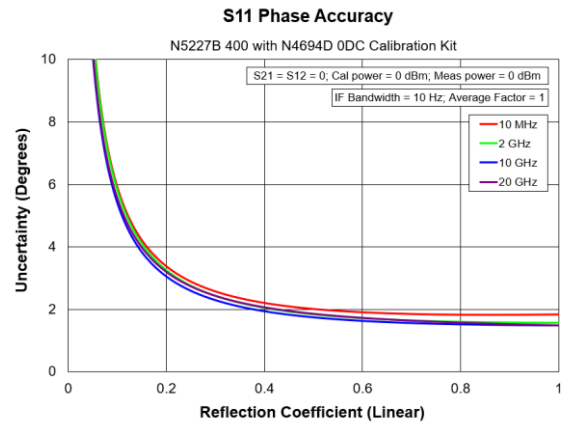
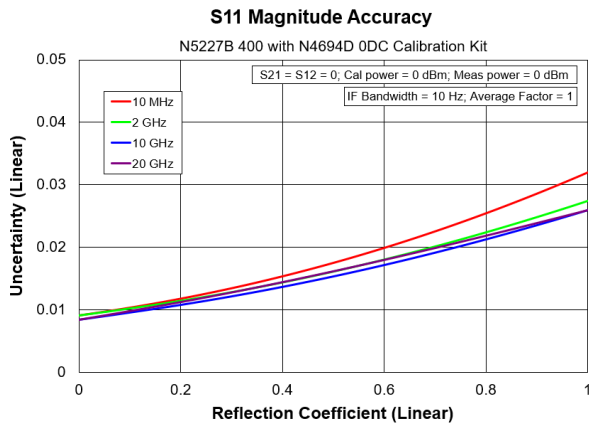
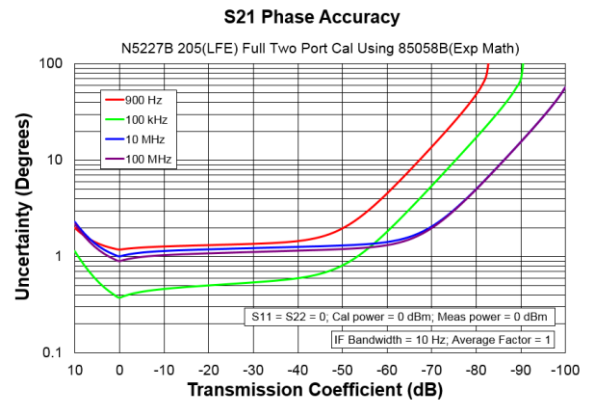
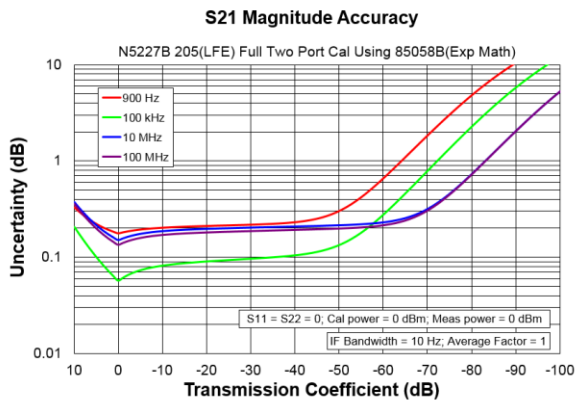

Table 4d. N5227B with 85058B Calibration Kit, All LFE Options (LFE Enabled)

Description	Specification (dB)							
	900 Hz to 1 kHz	1 kHz to 10 kHz	10 kHz to 100 kHz	100 kHz to 1 MHz	1 MHz to 5 MHz	5 MHz to 10 MHz	10 MHz to 50 MHz	50 MHz to 100 MHz
Directivity	35	35	35	35	35	35	35	35
Source Match	34	34	34	34	34	34	34	34
Load Match	35	35	35	35	35	35	35	35
Reflection Tracking								
Mag	±0.019	±0.019	±0.019	±0.019	±0.019	±0.019	±0.019	±0.019
Phase (°)	±0.125	±0.125	±0.125	±0.125	±0.125	±0.125	±0.125	±0.125
Transmission Tracking								
Mag	±0.167	±0.149	±0.047	±0.103	±0.140	±0.140	±0.125	±0.125
Phase (°)	±1.105	±0.983	±0.309	±0.680	±0.926	±0.926	±0.823	±0.823

### Transmission Uncertainty, All LFE Options

**NOTE** The plots are valid for all LFE options.



## Reflection Uncertainty, All LFE Options

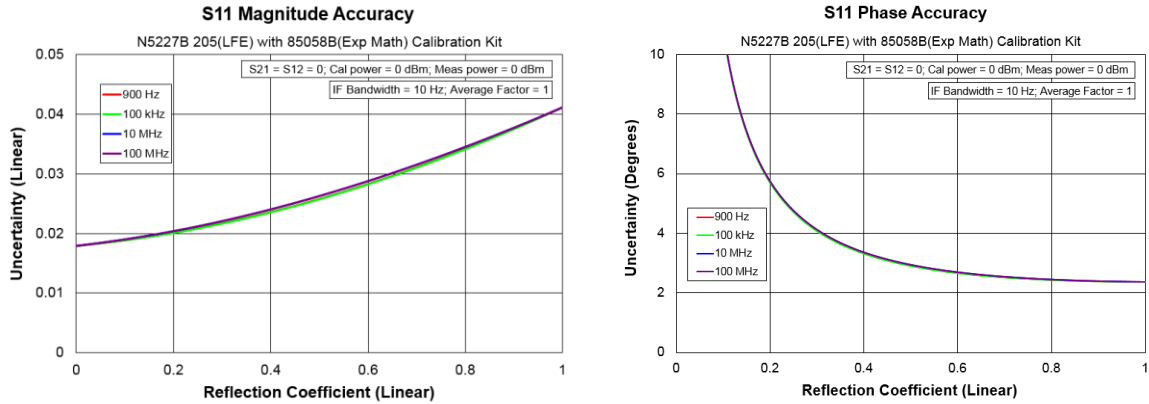
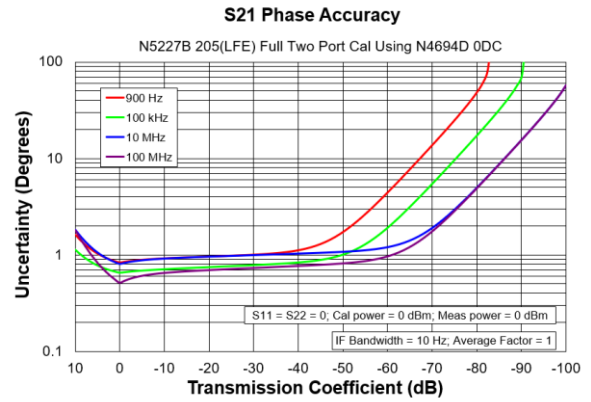
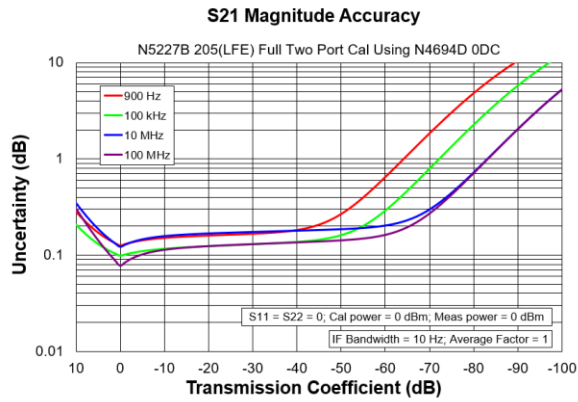

Table 4e. N5227B with N4694D Calibration Kit, All LFE Options (LFE Enabled)

Description	Specification (dB)							
	900 Hz to 1 kHz	1 kHz to 10 kHz	10 kHz to 100 kHz	100 kHz to 1 MHz	1 MHz to 5 MHz	5 MHz to 10 MHz	10 MHz to 50 MHz	50 MHz to 100 MHz
Directivity	41	41	41	41	41	41	41	41
Source Match	38	38	38	38	38	38	38	38
Load Match	35	35	37	37	36	35	35	36
Reflection Tracking Mag	±0.081	±0.081	±0.081	±0.081	±0.081	±0.081	±0.081	±0.041
Phase (°)	±0.54	±0.54	±0.54	±0.54	±0.54	±0.54	±0.54	±0.27
Transmission Tracking Mag	±0.12	±0.12	±0.089	±0.089	±0.11	±0.12	±0.12	±0.068
Phase (°)	±0.76	±0.76	±0.59	±0.59	±0.68	±0.74	±0.74	±0.45

## Transmission Uncertainty, All LFE Options

**NOTE** The plots are valid for all LFE options.



## Reflection Uncertainty, All LFE Options

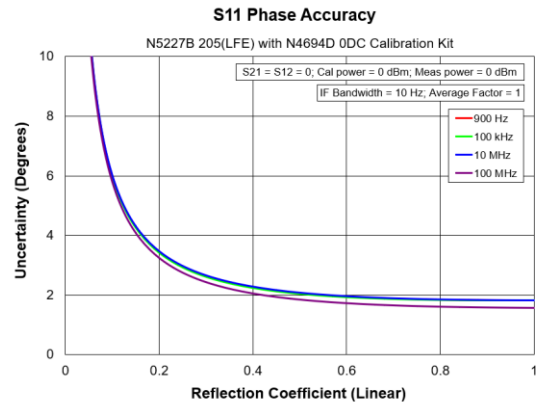
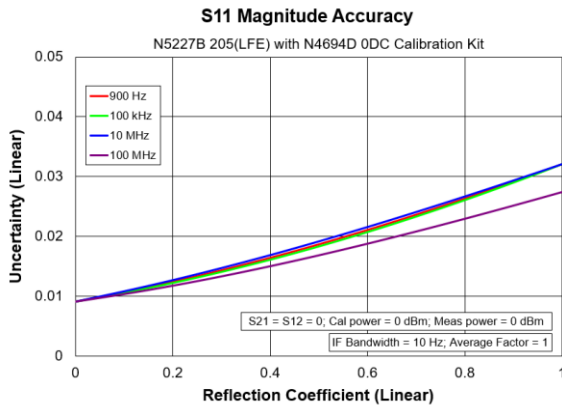

## Uncorrected System Performance

Specifications apply to following conditions:

- Cable loss not included in Transmission Tracking.
- Crosstalk measurement conditions: normalized to a thru, measured with shorts on all ports, 10 Hz IF bandwidth, averaging factor of 8, alternate mode, source power set to the specified maximum power.

Table 5a. Error Terms (dB), All Ports, All Options - Specifications

	Directivity	Source Match	Load Match	Transmission Tracking	Reflection Tracking	Crosstalk
10 MHz to 50 MHz <sup>1</sup>	17 (17)	7 (6) [7]	6 (6)	--	--	--
50 MHz to 500 MHz <sup>1</sup>	24 (24)	15 (7) [6]	11 (7)	--	--	--
500 MHz to 2 GHz	24 (24)	10 (7) [6]	7 (7)	--	--	--
2 GHz to 3.2 GHz	20 (20)	10 (7) [8]	7 (7)	--	--	--
3.2 GHz to 10 GHz	20 (20)	7 (7) [7]	7 (7)	--	--	--
10 GHz to 16 GHz	16 (16)	7 (6) [7]	6 (6)	--	--	--
16 GHz to 20 GHz	16 (16)	7 (7) [7]	7 (7)	--	--	--
20 GHz to 26.5 GHz	14 (14)	7 (7) [7]	7 (7)	--	--	--
26.5 GHz to 50 GHz	13 (11)	7 (6) [7]	6 (6)	--	--	--
50 GHz to 60 GHz	13 (13)	7 (7) [6]	7 (7)	--	--	--
60 GHz to 67 GHz	10 (10)	6 (6) [5]	6 (6)	--	--	--
67 GHz to 70 GHz	--	--	--	--	--	--

( ) With an LFE option installed except for Source Match.

[ ] With option 220, 420 for Source Match only.

<sup>1</sup> With an LFE option installed and LFE disabled, applied to frequencies  $\leq 100$  MHz. Above 100 MHz, performance is the same for both LFE enabled or disabled. For LFE enabled performance  $\leq 100$  MHz, see Table 5b.

Table 5b. Error Terms (dB), All Ports, All LFE Options (LFE Enabled) - Specifications

Description	Directivity	Source Match	Load Match	Transmission Tracking	Reflection Tracking	Crosstalk
1 kHz to 10 kHz	1	7	7	--	--	--
10 kHz to 1 MHz	16	15	19	--	--	--
1 MHz to 5 MHz	16	9	11	--	--	--
5 MHz to 50 MHz	5	7	8	--	--	--
50 MHz to 100 MHz	5	8	9	--	--	--

Table 5c. Error Terms (dB), All Ports, All Options - Typical

	Directivity	Source Match	Load Match	Transmission Tracking	Reflection Tracking	Crosstalk
10 MHz to 50 MHz <sup>1</sup>	20 (20)	9 (9)	8 (8)	±1.0	±1.0	-88 (-81)
50 MHz to 200 MHz <sup>1</sup>	28 (28)	19 (10)	17 (10)	±1.0	±1.0	-112 (-107)
200 MHz to 500 MHz	28 (28)	19 (8)	17 (8)	±1.0	±1.0	-129 (-121)
500 MHz to 2 GHz	31 (31)	14 (9)	12 (8)	±1.0	±1.0	-131 (-128)
2 GHz to 3.2 GHz	28 (28)	14 (13)	12 (12)	±1.0	±1.0	-127 (-124)
3.2 GHz to 10 GHz	25 (25)	11 (11)	10 (10)	±1.0	±1.0	-127 (-125)
10 GHz to 13.5 GHz	23 (23)	10 (10)	10 (10)	±1.0	±1.0	-127 (-125)
13.5 GHz to 16 GHz	23 (23)	11 (11)	11 (11)	±1.0	±1.0	-127 (-125)
16 GHz to 20 GHz	20 (20)	11 (11)	11 (11)	±1.0	±1.0	-127 (-125)
20 GHz to 26.5 GHz	18 (18)	11 (11)	11 (11)	±1.0	±1.0	-126 (-124)
26.5 GHz to 43.5 GHz	16 (16)	11 (11)	11 (11)	±1.0	±1.0	-112 (-111)
43.5 GHz to 50 GHz	19 (16)	11 (11)	11 (11)	±1.0	±1.0	-115 (-114)
50 GHz to 60 GHz	16 (16)	11 (11)	12 (12)	±1.0	±1.0	-111 (-110)
60 GHz to 67 GHz	16 (16)	9 (9)	10 (10)	±1.0	±1.0	-112 (-111)
67 GHz to 70 GHz	15 (15)	10 (10)	10 (10)	±1.0	±1.5	-109 (-108)

( ) With an LFE option installed.

<sup>1</sup> With an LFE option installed and LFE disabled, applied to frequencies <= 100 MHz. Above 100 MHz, performance is the same for both LFE enabled or disabled. For LFE enabled performance <= 100 MHz, see Table 5d.

Table 5d. Error Terms (dB), All Ports, All LFE Options (LFE Enabled) - Typical

Description	Directivity	Source Match	Load Match	Transmission Tracking	Reflection Tracking	Crosstalk
500 Hz to 900 Hz	--	--	--	--	--	-102
900 Hz to 1 kHz	4	8	9	±1.5	±1.5	-106
1 kHz to 10 kHz	5	9	8	±1.5	±1.5	-100
10 kHz to 100 kHz	23	19	23	±1.5	±1.5	-106
100 kHz to 1 MHz	23	19	23	±1.5	±1.5	-126
1 MHz to 5 MHz	26	13	14	±1.5	±1.5	-121
5 MHz to 10 MHz	11	9	10	±1.5	±1.5	-121
10 MHz to 50 MHz	11	9	10	±1.5	±1.5	-117
50 MHz to 100 MHz	11	11	11	±1.5	±1.5	-117

## Test Port Output

Table 6. Frequency Information, All Options

Description	Specification	Typical
N5227B Frequency Range	10 MHz to 67 GHz	67 GHz to 70 GHz
N5227B Frequency Range (LFE Options) <sup>1</sup>	900 Hz to 67 GHz	500 Hz to 900 Hz
Frequency Resolution	1 Hz	--
Frequency Accuracy	±1 ppm	--
Frequency Stability	--	±0.05 ppm, -10° to 70° C <sup>2</sup> ±0.1 ppm/yr maximum <sup>3</sup>

<sup>1</sup> Extended frequency down to 500 Hz.

<sup>2</sup> Assumes no variation in time.

<sup>3</sup> Assumes no variation in temperature.

Table 7a. Maximum Levelled Power (dBm) - Specification

Description	Option 200, 400		Option 201, 401		Option 219, 419	
	Port 1, Port 3	Port 2, Port 4	Port 1, Port 3	Port 2, Port 4	Port 1, Port 3	Port 2, Port 4
10 MHz to 50 MHz	10	10	10	10	9	9
50 MHz to 2 GHz	13	13	13	13	13	13
2 GHz to 3.2 GHz	10	13	10	13	9	13
3.2 GHz to 10 GHz	13	13	13	13	11	12
10 GHz to 13.5 GHz	12	12	11	11	9	9
13.5 GHz to 16 GHz	12	12	12	12	10	10
16 GHz to 19 GHz	11	11	10	10	8	8
19 GHz to 24 GHz	11	11	11	11	8	8
24 GHz to 26.5 GHz	11	11	11	11	7	7
26.5 GHz to 30 GHz	10	10	10	10	7	7
30 GHz to 32 GHz	9	9	7	7	5	5
32 GHz to 35 GHz	10	10	9	9	6	6
35 GHz to 40 GHz	5	5	5	5	1	1
40 GHz to 50 GHz	11	11	10	10	6	6
50 GHz to 64 GHz	11	11	10	10	5	5
64 GHz to 67 GHz	11	11	10	10	4	4

Table 7b. Maximum Leveled Power (dBm) - Typical

Description	Option 200, 400		Option 201, 401		Option 219, 419	
	Port 1, Port 3	Port 2, Port 4	Port 1, Port 3	Port 2, Port 4	Port 1, Port 3	Port 2, Port 4
10 MHz to 50 MHz	20	17	19	17	19	17
50 MHz to 500 MHz	20	18	20	18	19	17
500 MHz to 1 GHz	20	21	20	20	19	18
1 GHz to 2 GHz	18	20	18	20	17	18
2 GHz to 3.2 GHz	17	18	17	17	15	17
3.2 GHz to 10 GHz	19	19	19	18	18	18
10 GHz to 13.5 GHz	18	16	17	15	16	14
13.5 GHz to 16 GHz	19	18	18	17	17	16
16 GHz to 19 GHz	17	17	17	16	14	14
19 GHz to 20 GHz	17	17	17	16	13	13
20 GHz to 24 GHz	16	16	16	15	12	13
24 GHz to 30 GHz	15	15	15	14	12	12
30 GHz to 32 GHz	14	14	13	13	11	11
32 GHz to 35 GHz	15	15	14	14	12	12
35 GHz to 40 GHz	13	13	12	11	9	9
40 GHz to 43.5 GHz	12	12	11	12	11	10
43.5 GHz to 50 GHz	12	13	11	12	10	10
50 GHz to 60 GHz	12	13	12	12	10	9
60 GHz to 64 GHz	12	13	12	12	9	9
64 GHz to 67 GHz	13	14	13	13	8	8
67 GHz to 70 GHz	13	14	12	12	4	4



Table 7c. Maximum Levelled Power (dBm) – All LFE Options – Specification

Description	Option 205, 405		Option 220, 420	
	Port 1, Port 3	Port 2, Port 4	Port 1, Port 3	Port 2, Port 4
10 MHz to 50 MHz <sup>1</sup>	3	3	2	2
50 MHz to 2 GHz <sup>1</sup>	8	8	9	9
2 GHz to 3.2 GHz	9	9	6	10
3.2 GHz to 10 GHz	9	9	9	10
10 GHz to 13.5 GHz	9	11	7	7
13.5 GHz to 16 GHz	9	10	8	8
16 GHz to 19 GHz	8	8	6	6
19 GHz to 24 GHz	9	9	6	6
24 GHz to 26.5 GHz	7	7	5	5
26.5 GHz to 30 GHz	8	8	6	6
30 GHz to 32 GHz	8	8	4	4
32 GHz to 35 GHz	7	7	5	5
35 GHz to 40 GHz	5	5	0	0
40 GHz to 50 GHz	6	6	5	5
50 GHz to 64 GHz	3	3	4	4
64 GHz to 67 GHz	8	8	3	3

<sup>1</sup> With an LFE option installed and LFE disabled, applied to frequencies <= 100 MHz. Above 100 MHz, performance is the same for both LFE enabled or disabled. For LFE enabled performance <= 100 MHz, see Table 7e.

Table 7d. Maximum Levelled Power (dBm) – All LFE Options - Typical

Description	Option 205, 405		Option 220, 420	
	Port 1, Port 3	Port 2, Port 4	Port 1, Port 3	Port 2, Port 4
10 MHz to 50 MHz <sup>1</sup>	12	10	12	10
50 MHz to 500 MHz <sup>1</sup>	15	13	15	13
500 MHz to 1 GHz	16	16	16	15
1 GHz to 2 GHz	14	16	14	15
2 GHz to 3.2 GHz	16	15	12	14
3.2 GHz to 10 GHz	15	15	16	16
10 GHz to 13.5 GHz	14	12	14	12
13.5 GHz to 16 GHz	15	14	15	14
16 GHz to 19 GHz	14	13	12	12
19 GHz to 20 GHz	13	12	11	11
20 GHz to 24 GHz	13	12	10	11
24 GHz to 30 GHz	12	11	10	10
30 GHz to 32 GHz	11	11	10	10
32 GHz to 35 GHz	11	11	11	11
35 GHz to 40 GHz	10	9	8	8
40 GHz to 43.5 GHz	9	10	10	9
43.5 GHz to 50 GHz	9	10	9	9
50 GHz to 60 GHz	9	9	9	8
60 GHz to 64 GHz	9	9	8	8
64 GHz to 67 GHz	9	9	7	7
67 GHz to 70 GHz	--	--	3	3

<sup>1</sup> With an LFE option installed and LFE disabled, applied to frequencies <= 100 MHz. Above 100 MHz, performance is the same for both LFE enabled or disabled. For LFE enabled performance <= 100 MHz, see Table 7e.

Table 7e. Maximum Power (dBm), All Ports – All LFE Options (LFE Enabled)

Description	Specification	Typical <sup>1</sup>
500 Hz to 900 Hz	--	12
900 Hz to 1 kHz	10	13
1 kHz to 10 kHz	12	13
10 kHz to 100 kHz	12	14
100 kHz to 1 MHz	12	14
1 MHz to 5 MHz	10	13
5 MHz to 10 MHz	9	11
10 MHz to 50 MHz	8	10
50 MHz to 100 MHz	8	10

<sup>1</sup> Values apply to all ports. Ports 2 and 4 typically 1 dB higher.

Table 8a. Power Level Accuracy (dB) at Nominal Power<sup>1</sup>, All Options

Description	Specification	Typical
10 MHz to 50 MHz <sup>2</sup>	±1.8	±0.4
50 MHz to 1 GHz <sup>2</sup>	±1.0	±0.4
1 GHz to 3.2 GHz	±1.0	±0.2
3.2 GHz to 20 GHz	±2.0	±0.4
20 GHz to 26.5 GHz	±2.2	±0.4
26.5 GHz to 40 GHz	±3.0	±0.5
40 GHz to 43.5 GHz	±3.0	±0.3
43.5 GHz to 50 GHz	±3.0	±0.5
50 GHz to 60 GHz	±3.5	±0.6
60 GHz to 67 GHz	±4.0	±0.7
67 GHz to 70 GHz	--	±1.0

<sup>1</sup> Level accuracy at power other than nominal power, Power Level Accuracy (dB) at Nominal Power + Power Level Linearity (dB).

<sup>2</sup> With an LFE option installed and LFE disabled, applied to frequencies ≤ 100 MHz. Above 100 MHz, performance is the same for both LFE enabled or disabled. For LFE enabled performance ≤ 100 MHz, see Table 8b.

Table 8b. Power Level Accuracy (dB), All Ports, All LFE Options (LFE Enabled)

Description	Specification	Typical
500 Hz to 900 Hz	--	±0.1
900 Hz to 1 kHz	±1.0	±0.1
1 kHz to 10 kHz	±1.0	±0.1
10 kHz to 100 kHz	±1.0	±0.1
100 kHz to 1 MHz	±1.0	±0.15
1 MHz to 5 MHz	±1.0	±0.15
5 MHz to 10 MHz	±1.0	±0.2
10 MHz to 50 MHz	±1.0	±0.2
50 MHz to 100 MHz	±1.0	±0.2

Table 9a. Power Level Linearity<sup>1</sup> (dB), All Options - Specification

Description	Port 1 or 3 <sup>2</sup> -25dBm ≤ P < -20dBm	Port 1 or 3 <sup>2</sup> -20dBm ≤ P < -15dBm	Port 1 or 3 <sup>2</sup> P ≥ -15dBm
10 MHz to 50 MHz <sup>3</sup>	±2.7	±1.7	±1.5
50 MHz to 500 MHz <sup>3</sup>	±1.7	±1.5	±1.5
500 MHz to 67 GHz <sup>3</sup>	±1.5	±1.5	±1.5

<sup>1</sup> Referenced to nominal power.

<sup>2</sup> Either port can be used as the source port.

<sup>3</sup> With an LFE option installed and LFE disabled, applied to frequencies ≤ 100 MHz. Above 100 MHz, performance is the same for both LFE enabled or disabled. For LFE enabled performance ≤ 100 MHz, see Table 9c.

Table 9b. Power Level Linearity<sup>1</sup> (dB), All Options - Specification

Description	Port 2 or 4 <sup>2</sup> -25dBm ≤ P < -20dBm	Port 2 or 4 <sup>2</sup> -20dBm ≤ P < -15dBm	Port 2 or 4 <sup>2</sup> P ≥ -15dBm
10 MHz to 50 MHz <sup>3</sup>	±3.5	±1.7	±1.5
50 MHz to 500 MHz <sup>3</sup>	±2.7	±1.5	±1.5
500 MHz to 3.2 GHz	±2.5	±1.5	±1.5
3.2 GHz to 67 GHz	±1.5	±1.5	±1.5

<sup>1</sup> Referenced to nominal power.

<sup>2</sup> Either port can be used as the source port.

<sup>3</sup> With an LFE option installed and LFE disabled, applied to frequencies ≤ 100 MHz. Above 100 MHz, performance is the same for both LFE enabled or disabled. For LFE enabled performance ≤ 100 MHz, see Table 9c.

Table 9c. Power Level Linearity<sup>1</sup> (dB), All Ports, All LFE Options (LFE Enabled)

Description	Specification
500 Hz to 900 Hz	--
900 Hz to 100 MHz	±1.0

<sup>1</sup> Referenced to nominal power.

Table 10a. Power Sweep Range (dB) - Specification

Description	Option 200, 400		Option 201, 401		Option 219, 419	
	Port 1, Port 3	Port 2, Port 4	Port 1, Port 3	Port 2, Port 4	Port 1, Port 3	Port 2, Port 4
10 MHz to 50 MHz	37	37	37	37	36	36
50 MHz to 2 GHz	38	38	38	38	38	38
2 GHz to 3.2 GHz	35	38	35	38	34	38
3.2 GHz to 10 GHz	38	38	38	38	36	37
10 GHz to 13.5 GHz	37	37	36	36	34	34
13.5 GHz to 16 GHz	37	37	37	37	35	35
16 GHz to 19 GHz	36	36	35	35	33	33
19 GHz to 24 GHz	36	36	36	36	33	33
24 GHz to 26.5 GHz	36	36	36	36	32	32
26.5 GHz to 30 GHz	35	35	35	35	32	32
30 GHz to 32 GHz	34	34	32	32	30	30
32 GHz to 35 GHz	35	35	34	34	31	31
35 GHz to 40 GHz	30	30	30	30	26	26
40 GHz to 50 GHz	36	36	35	35	31	31
50 GHz to 64 GHz	36	36	35	35	30	30
64 GHz to 67 GHz	36	36	35	35	29	29

Table 10b. Power Sweep Range (dB) - Typical

Description	Option 200, 400		Option 201, 401		Option 219, 419	
	Port 1, Port 3	Port 2, Port 4	Port 1, Port 3	Port 2, Port 4	Port 1, Port 3	Port 2, Port 4
10 MHz to 50 MHz	47	44	46	44	46	44
50 MHz to 500 MHz	47	45	47	45	46	44
500 MHz to 1 GHz	47	48	47	47	46	45
1 GHz to 2 GHz	45	47	45	47	44	45
2 GHz to 3.2 GHz	44	45	44	44	42	44
3.2 GHz to 10 GHz	46	46	46	45	45	45
10 GHz to 13.5 GHz	45	43	44	42	43	41
13.5 GHz to 16 GHz	46	45	45	44	44	43
16 GHz to 19 GHz	44	44	44	43	41	41
19 GHz to 20 GHz	44	44	44	43	40	40
20 GHz to 24 GHz	43	43	43	42	39	40
24 GHz to 30 GHz	42	42	42	41	39	39
30 GHz to 32 GHz	41	41	40	40	38	38
32 GHz to 35 GHz	42	42	41	41	39	39
35 GHz to 40 GHz	40	40	39	38	36	36
40 GHz to 43.5 GHz	39	39	38	39	38	37
43.5 GHz to 50 GHz	39	40	38	39	37	37
50 GHz to 60 GHz	39	40	39	39	37	36
60 GHz to 64 GHz	39	40	39	39	36	36
64 GHz to 67 GHz	40	41	40	40	35	35
67 GHz to 70 GHz	40	41	39	39	31	31

Table 10c. Power Sweep Range (dB) – All LFE Options – Specification

Description	Option 205, 405		Option 220, 420	
	Port 1, Port 3	Port 2, Port 4	Port 1, Port 3	Port 2, Port 4
10 MHz to 50 MHz <sup>1</sup>	28	28	29	29
50 MHz to 2 GHz <sup>1</sup>	33	33	34	34
2 GHz to 3.2 GHz	34	34	31	35
3.2 GHz to 10 GHz	34	34	34	35
10 GHz to 13.5 GHz	34	36	32	32
13.5 GHz to 16 GHz	34	35	33	33
16 GHz to 19 GHz	33	33	31	31
19 GHz to 24 GHz	34	34	31	31
24 GHz to 26.5 GHz	32	32	30	30
26.5 GHz to 30 GHz	32	32	31	31
30 GHz to 32 GHz	32	32	29	29
32 GHz to 35 GHz	32	32	30	30
35 GHz to 40 GHz	30	30	25	25
40 GHz to 50 GHz	31	31	30	30
50 GHz to 64 GHz	28	28	29	29
64 GHz to 67 GHz	33	33	28	28

<sup>1</sup> With an LFE option installed and LFE disabled, applied to frequencies <= 100 MHz. Above 100 MHz, performance is the same for both LFE enabled or disabled. For LFE enabled performance <= 100 MHz, see Table 10e.

Table 10d. Power Sweep Range (dB) – All LFE Options – Typical

Description	Option 205, 405		Option 220, 420	
	Port 1, Port 3	Port 2, Port 4	Port 1, Port 3	Port 2, Port 4
10 MHz to 50 MHz <sup>1</sup>	39	37	39	37
50 MHz to 500 MHz <sup>1</sup>	42	40	42	40
500 MHz to 1 GHz	43	43	43	42
1 GHz to 2 GHz	43	43	41	42
2 GHz to 3.2 GHz	43	43	39	41
3.2 GHz to 10 GHz	41	43	43	43
10 GHz to 13.5 GHz	43	42	41	39
13.5 GHz to 16 GHz	42	42	42	41
16 GHz to 19 GHz	41	39	39	39
19 GHz to 20 GHz	41	39	38	38
20 GHz to 24 GHz	42	41	37	38
24 GHz to 30 GHz	40	39	37	37
30 GHz to 32 GHz	39	38	37	37
32 GHz to 35 GHz	39	38	38	38
35 GHz to 40 GHz	38	38	35	35
40 GHz to 43.5 GHz	38	38	37	36
43.5 GHz to 50 GHz	38	38	36	36
50 GHz to 60 GHz	37	36	36	35
60 GHz to 64 GHz	37	36	35	35
64 GHz to 67 GHz	36	37	34	34
67 GHz to 70 GHz	??	??	30	30

<sup>1</sup> With an LFE option installed and LFE disabled, applied to frequencies <= 100 MHz. Above 100 MHz, performance is the same for both LFE enabled or disabled. For LFE enabled performance <= 100 MHz, see Table 10e.



Table 10e. Power Sweep Range (dB) – All LFE Options (LFE Enabled)

Description	Specification	Typical
500 Hz to 900 Hz	--	39
900 Hz to 1 kHz	35	40
1 kHz to 10 kHz	37	40
10 kHz to 100 kHz	37	41
100 kHz to 1 MHz	37	41
1 MHz to 5 MHz	35	40
5 MHz to 10 MHz	34	38
10 MHz to 50 MHz	33	37
50 MHz to 100 MHz	33	37

Table 11. Nominal (Preset) Power (dBm)

Description	Option 200, 201, 205, 400, 401, 405	Option 219, 220, 419, 420
Preset Power	0	-5

Table 12. Power Resolution and Maximum/Minimum Settable Power, All Models and Options

Description	Specification (dB)	Typical (dBm)
Power Resolution	0.01	--
Maximum Settable Power	--	30
Minimum Settable Power		
Option 200, 201, 205, 400, 401, 405	--	-30
Option 219, 220, 419, 420	--	-80

Table 13a. 2<sup>nd</sup> and 3<sup>rd</sup> Harmonics at Max Specified Power (dBc) All Options – Typical

Listed frequency is harmonic frequency; test at max specified power

Description	N5227B
20 MHz to 4 GHz <sup>1</sup>	-17
4 GHz to 24 GHz	-20
24 GHz to 27 GHz	-21
27 GHz to 40.5 GHz	-32
40.5 GHz to 67 GHz	-60
67 GHz to 70 GHz	-60

<sup>1</sup> With an LFE option installed and LFE disabled, applied to frequencies <= 100 MHz. Above 100 MHz, performance is the same for both LFE enabled or disabled. For LFE enabled performance <= 100 MHz, see Table 13b.

Table 13b. 2<sup>nd</sup> and 3<sup>rd</sup> Harmonics at Max Specified Power (dBc), All Ports, All LFE Options (LFE Enabled) - Typical

Listed frequency is fundamental frequency; test at max specified power

Description	2 <sup>nd</sup> Harmonic	3 <sup>rd</sup> Harmonic
500 Hz to 900 Hz	-32	-31
900 Hz to 1 kHz	-22	-23
1 kHz to 10 kHz	-22	-23
10 kHz to 100 kHz	-22	-23
100 kHz to 1 MHz	-25	-22
1 MHz to 5 MHz	-28	-24
5 MHz to 10 MHz	-27	-22
10 MHz to 33 MHz	-28	-21
33 MHz to 50 MHz	-28	--

Table 14. Non-Harmonic Spurs at Nominal Power (dBc), All Options - Typical

Description	Based on 100kHz offset Frac-N
10 MHz to 500 MHz <sup>1</sup>	-50
500 MHz to 2 GHz	-42
2 GHz to 4 GHz	-45
4 GHz to 8 GHz	-39
8 GHz to 16 GHz	-33
16 GHz to 32 GHz	-27
32 GHz to 64 GHz	-21
64 GHz to 70 GHz	-15

<sup>1</sup> Non-harmonic spurs are negligible with LFE options installed and LFE enabled.

Table 15a. Phase Noise (dBc/Hz), All Options - Typical

Description	1 kHz Offset	10 kHz Offset	100 kHz Offset	1 MHz Offset
10 MHz to 500 MHz <sup>1</sup>	-100	-95	-95	-120
500 MHz to 1 GHz	-107	-117	-112	-127
1 GHz to 2 GHz	-101	-111	-106	-121
2 GHz to 4 GHz	-95	-105	-100	-115
4 GHz to 8 GHz	-89	-99	-94	-109
8 GHz to 16 GHz	-83	-93	-88	-103
16 GHz to 32 GHz	-77	-87	-82	-97
32 GHz to 64 GHz	-71	-81	-76	-91
64 GHz to 70 GHz	-65	-75	-70	-85

<sup>1</sup> With an LFE option installed and LFE disabled, applied to frequencies <= 100 MHz. Above 100 MHz, performance is the same for both LFE enabled or disabled. For LFE enabled performance <= 100 MHz, see Table 15b.

Table 15b. Phase Noise (dBc/Hz), All Ports, All LFE Options (LFE Enabled) - Typical

Description	1 kHz Offset	10 kHz Offset	100 kHz Offset	1 MHz Offset
500 Hz to 100 MHz	-120	-130	-125	-135

## Test Port Input

Table 16a. Test Port Noise Floor (dBm) @ 10 Hz IFBW, All Options

Total average (rms) noise power calculated as the mean value of a linear magnitude trace expressed in dBm. May typically be degraded at particular frequencies below 500 MHz due to spurious receiver residuals.

Description	Specification	Typical
10 MHz to 50 MHz <sup>1</sup>	-70	-76
50 MHz to 100 MHz <sup>1</sup>	-92	-97
100 MHz to 500 MHz	-101	-106
500 MHz to 1 GHz	-110	-115
1 GHz to 10 GHz	-114	-119
10 GHz to 13.5 GHz	-114	-120
13.5 GHz to 24 GHz	-116	-121
24 GHz to 26.5 GHz	-117	-121
26.5 GHz to 35 GHz	-106	-112
35 GHz to 40 GHz	-104	-110
40 GHz to 50 GHz	-101	-108
50 GHz to 60 GHz	-101	-107
60 GHz to 67 GHz	-101	-108
67 GHz to 70 GHz	--	-106

<sup>1</sup> With an LFE option installed and LFE disabled, applied to frequencies  $\leq 100$  MHz. Above 100 MHz, performance is the same for both LFE enabled or disabled. For LFE enabled performance  $\leq 100$  MHz, see Table 16b.

Table 16b. Test Port Noise Floor (dBm) @ 10 Hz IFBW, All LFE Options (LFE Enabled)

Description	Specification	Typical
500 Hz to 900 Hz	--	-93
900 Hz to 1 kHz	-90	-96
1 kHz to 10 kHz	-91	-96
10 kHz to 100 kHz	-101	-105
100 kHz to 1 MHz	-107	-110
1 MHz to 5 MHz	-108	-112
5 MHz to 10 MHz	-102	-106
10 MHz to 50 MHz	-102	-106
50 MHz to 100 MHz	-102	-106

**Table 17. Direct Receiver Access Input Noise Floor (dBm) @ 10 Hz IFBW**

Total average (rms) noise power calculated as the mean value of a linear magnitude trace expressed in dBm.

May typically be degraded at particular frequencies below 500 MHz due to spurious receiver residuals.

Description	Specification	Typical
	Options 201, 205, 219, 220, 401, 405, 419, 420	Options 201, 205, 219, 220, 401, 405, 419, 420
10 MHz to 50 MHz	--	-116
50 MHz to 100 MHz	-104	-124
100 MHz to 500 MHz	-113	-133
500 MHz to 1 GHz	-122	-142
1 GHz to 2 GHz	-126	-133
2 GHz to 10 GHz	-125	-133
10 GHz to 13.5 GHz	-125	-134
13.5 GHz to 24 GHz	-127	-135
24 GHz to 26.5 GHz	-128	-135
26.5 GHz to 30 GHz	-117	-126
30 GHz to 35 GHz	-116	-125
35 GHz to 40 GHz	-114	-123
40 GHz to 45 GHz	-111	-120
45 GHz to 50 GHz	-110	-120
50 GHz to 67 GHz	-109	-118
67 GHz to 70 GHz	--	-116

Table 18a. 0.1 dB Compression, Option 201, 219, 401, 419, and All LFE Options - Typical

Description	Test Port Power (dBm)
10 MHz to 100 MHz <sup>1</sup>	15
100 MHz to 30 GHz	12
30 GHz to 67 GHz	11

<sup>1</sup> With an LFE option installed and LFE disabled, applied to frequencies  $\leq 100$  MHz. Above 100 MHz, performance is the same for both LFE enabled or disabled. For LFE enabled performance  $\leq 100$  MHz, see Table 18b.

Table 18b. 0.1 dB Compression, All Ports, All LFE Options (LFE Enabled) - Typical

Description	Test Port Power (dBm)
500 Hz to 900 Hz	13
900 Hz to 1 kHz	13
1 kHz to 10 kHz	13
10 kHz to 100 kHz	13
100 kHz to 1 MHz	13
1 MHz to 5 MHz	11
5 MHz to 10 MHz	13
10 MHz to 50 MHz	14
50 MHz to 100 MHz	14

Table 18c. Compression - Specification

Description	Test Port Power (dBm)			Receiver Compression	
	Option 200, 400	Option 201, 205, 401, 405	Option 219, 220, 419, 420	Magnitude (dB)	Phase (degrees)
10 MHz to 500 MHz <sup>1</sup>	--	--	--	--	--
500 MHz to 2 GHz	10	13	13	0.15	1.2
2 GHz to 3.2 GHz	7	12	11	0.15	1.2
3.2 GHz to 10 GHz	10	13	12	0.15	1.2
10 GHz to 13.5 GHz	8	11	9	0.15	1.2
13.5 GHz to 16 GHz	8	12	10	0.15	1.2
16 GHz to 20 GHz	6	11	8	0.15	1.2
20 GHz to 24 GHz	6	11	8	0.15	1.2
24 GHz to 30 GHz	6	10	8	0.15	1.2
30 GHz to 35 GHz	5	9	8	0.15	1.2
35 GHz to 40 GHz	0	8	8	0.15	1.2
40 GHz to 67 GHz	4	10	8	0.15	1.2

<sup>1</sup>Test port receiver compression at specified input levels below 500 MHz due to coupler roll off in this frequency range.

Table 18d. Compression, All Ports, All LFE Options (LFE Enabled) - Specification

Description	Test Port Power (dBm)	Receiver Compression	
	All Options	Magnitude (dB)	Phase (degrees)
500 Hz to 900 Hz	--	--	--
900 Hz to 1 kHz	10	0.2	1
1 kHz to 10 kHz	12	0.2	1
10 kHz to 100 kHz	12	0.2	1
100 kHz to 1 MHz	12	0.2	1
1 MHz to 5 MHz	10	0.2	1
5 MHz to 10 MHz	9	0.2	1
10 MHz to 50 MHz	8	0.2	1
50 MHz to 100 MHz	8	0.2	1

Table 19a. Trace Noise<sup>2</sup> Magnitude (dB rms), All Options

Description	Specification	Typical		
		1 kHz IFBW	100 kHz IFBW	600 kHz IFBW
10 MHz to 50 MHz <sup>1</sup>	0.05	0.0177	0.173	0.416
50 MHz to 100 MHz <sup>1</sup>	0.006	0.0012	0.012	0.029
100 MHz to 500 MHz	0.002	0.0006	0.006	0.014
500 MHz to 1 GHz	0.002	0.0004	0.003	0.006
1 GHz to 26.5 GHz	0.002	0.0005	0.002	0.005
26.5 GHz to 50 GHz	0.003	0.0006	0.005	0.012
50 GHz to 67 GHz	0.003	0.0007	0.006	0.013
67 GHz to 70 GHz	--	0.0010	0.007	0.016

<sup>1</sup> With an LFE option installed and LFE disabled, applied to frequencies <= 100 MHz. Above 100 MHz, performance is the same for both LFE enabled or disabled.

<sup>2</sup> Ratioed measurement, nominal power at test port.

Table 19b. Trace Noise<sup>1</sup> Magnitude (dB rms), All Ports, All LFE Options (LFE Enabled)

Description	Specification		Typical			
	100 Hz IFBW	1 kHz IFBW	100 Hz IFBW	1 kHz IFBW	100 kHz IFBW	600 kHz IFBW
500 Hz to 900 Hz	--	--	0.002	--	--	--
900 Hz to 4 kHz	0.004	--	0.001	--	--	--
4 kHz to 300 kHz	--	0.004	--	0.002	--	--
300 kHz to 2 MHz	--	0.004	--	0.001	0.01	--
2 MHz to 100 MHz	--	0.004	--	0.001	0.01	0.025

<sup>1</sup> Ratioed measurement, nominal power at test port.



Table 20a. Trace Noise<sup>2</sup> Phase (deg rms), All Options

Description	Specification	Typical		
		1 kHz IFBW	100 kHz IFBW	600 kHz IFBW
10 MHz to 50 MHz <sup>1</sup>	0.400	0.1228	1.205	2.928
50 MHz to 100 MHz <sup>1</sup>	0.040	0.0083	0.080	0.196
100 MHz to 500 MHz	0.020	0.0040	0.037	0.097
500 MHz to 1 GHz	0.020	0.0017	0.015	0.037
1 GHz to 26.5 GHz	0.020	0.0075	0.015	0.031
26.5 GHz to 43.5 GHz	0.030	0.0125	0.040	0.091
43.5 GHz to 50 GHz	0.035	0.0149	0.040	0.092
50 GHz to 67 GHz	0.045	0.0200	0.048	0.110
67 GHz to 70 GHz	--	0.0213	0.050	0.119

<sup>1</sup> With an LFE option installed and LFE disabled, applied to frequencies <= 100 MHz. Above 100 MHz, performance is the same for both LFE enabled or disabled.

<sup>2</sup> Ratioed measurement, nominal power at test port.

Table 20b. Trace Noise<sup>1</sup> Phase (deg rms), All Ports, All LFE Options (LFE Enabled)

Description	Specification		Typical			
	100 Hz IFBW	1 kHz IFBW	100 Hz IFBW	1 kHz IFBW	100 kHz IFBW	600 kHz IFBW
500 Hz to 900 Hz	--	--	0.012	--	--	--
900 Hz to 4 kHz	0.03	--	0.008	--	--	--
4 kHz to 300 kHz	--	0.03	--	0.014	--	--
300 kHz to 2 MHz	--	0.03	--	0.007	0.064	--
2 MHz to 100 MHz	--	0.03	--	0.007	0.068	0.166

<sup>1</sup> Ratioed measurement, nominal power at test port.

Table 21. Reference Level Magnitude, All Models and Options - Specification

Description	Magnitude (dB)	Phase (degrees)
Range	±500	±500
Resolution	0.001	0.01

Table 22a. Stability, All Options - Typical

Description	Magnitude (dB/°C)	Phase (°/°C)
10 MHz to 50 MHz <sup>1</sup>	0.03	0.400
50 MHz to 3.2 GHz <sup>1</sup>	0.01	0.100
3.2 GHz to 20 GHz	0.01	0.200
20 GHz to 32 GHz	0.01	0.300
32 GHz to 35 GHz	0.02	0.400
35 GHz to 50 GHz	0.02	0.400
50 GHz to 67 GHz	0.03	0.600
67 GHz to 70 GHz	0.06	1.200

<sup>1</sup> With an LFE option installed and LFE disabled, applied to frequencies <= 100 MHz. Above 100 MHz, performance is the same for both LFE enabled or disabled. For LFE enabled performance <= 100 MHz, see Table 22b.

Table 22b. Stability<sup>1</sup>, All LFE Options (LFE Enabled) - Typical

Description	Magnitude (dB/°C)	Phase (°/°C)
500 Hz to 900 Hz	0.010	0.2
900 Hz to 1 kHz	0.010	0.2
1 kHz to 10 kHz	0.010	0.2
10 kHz to 100 kHz	0.010	0.2
100 kHz to 1 MHz	0.010	0.1
1 MHz to 5 MHz	0.010	0.1
5 MHz to 10 MHz	0.010	0.1
10 MHz to 50 MHz	0.010	0.1
50 MHz to 100 MHz	0.020	0.1

<sup>1</sup> Stability is defined as a ratio measurement made at the test port.

Table 23. Damage Input Level, All Options

Description	Option 200, 201, 219, 400, 401, 419	All LFE Options
N5227B	27 dBm, 40 V	20 dBm, 50 V

# Dynamic Accuracy

Dynamic accuracy is verified with the following measurements:

Compression over frequency

IF linearity at a single frequency of 1.998765GHz using a reference level of -20 dBm for an input power range of 0 to -60 dBm. For values below -60 dBm, refer to [VNA Receiver Dynamic Accuracy Specifications and Uncertainties](#).

Table 24. N5227B Dynamic Accuracy

## N5227B Dynamic Accuracy, 900 Hz, All LFE Options (LFE Enabled) - Specification

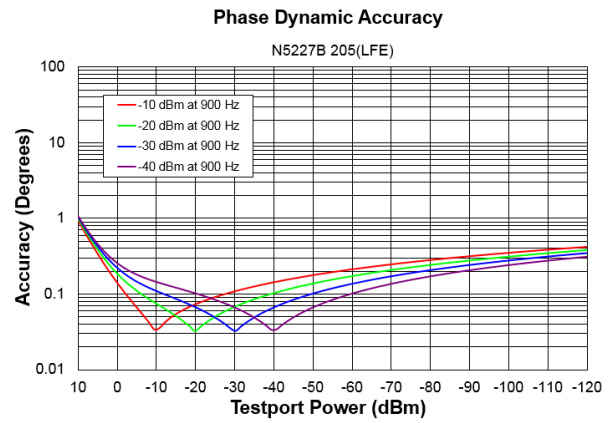
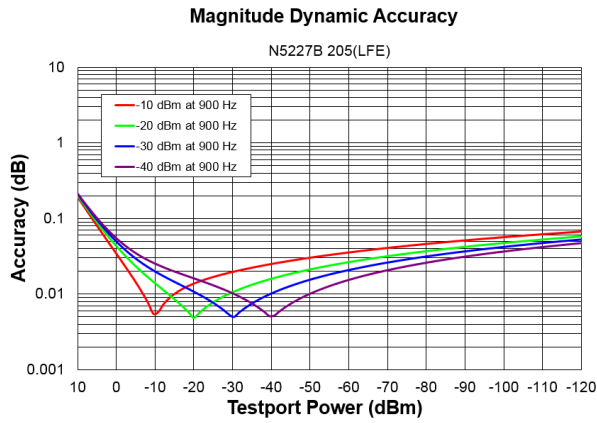

## N5227B Dynamic Accuracy, 10 MHz, All LFE Options (LFE Enabled) - Specification

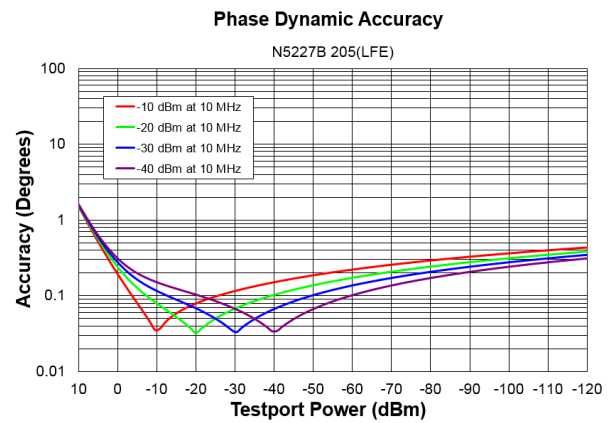
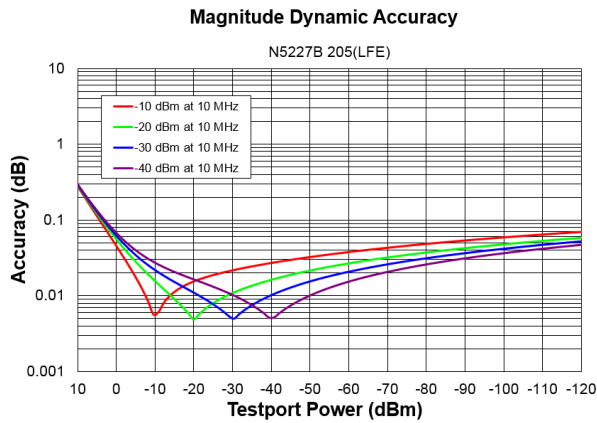

## N5227B Dynamic Accuracy, 100 MHz, All LFE Options (LFE Enabled) - Specification

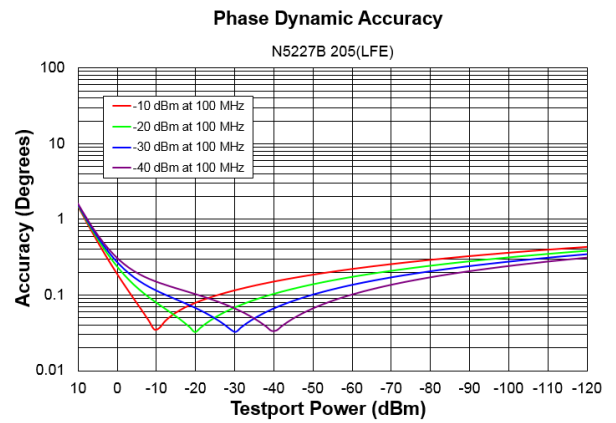
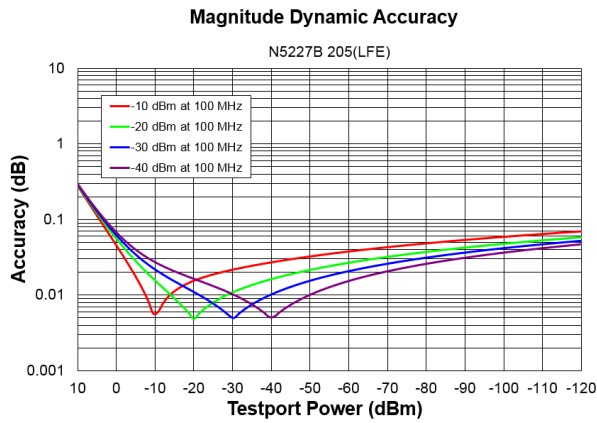

## N5227B Dynamic Accuracy, 10 MHz - Specification

**NOTE** The plots are valid for all options.

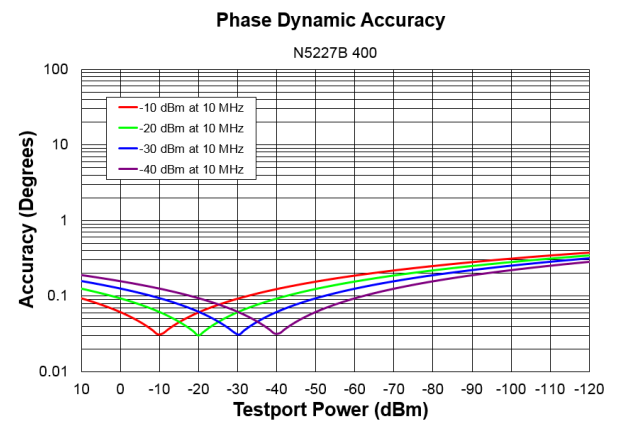
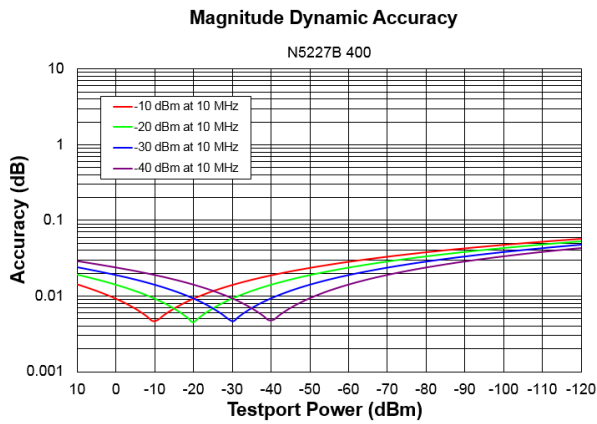

## N5227B Dynamic Accuracy, 50 MHz - Specification

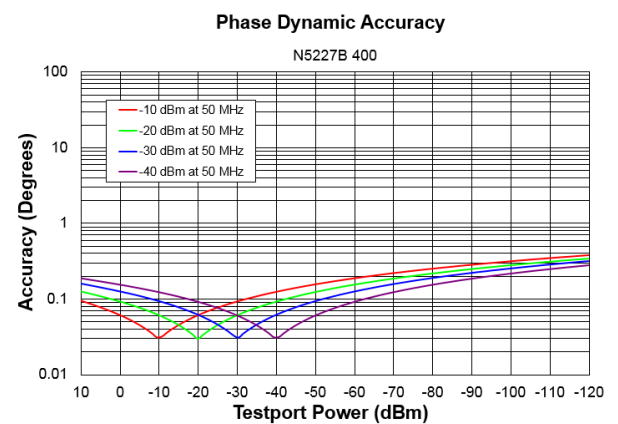
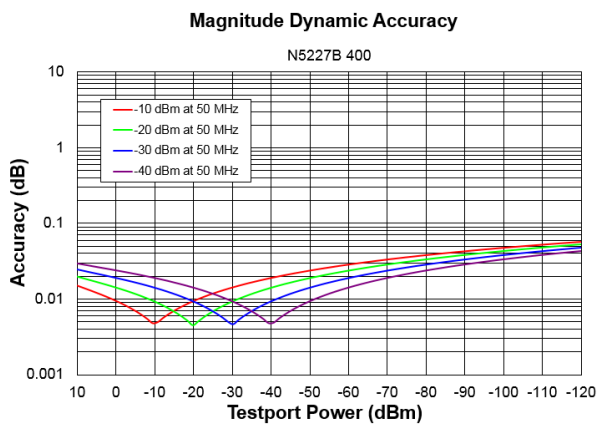

## N5227B Dynamic Accuracy, 500 MHz - Specification

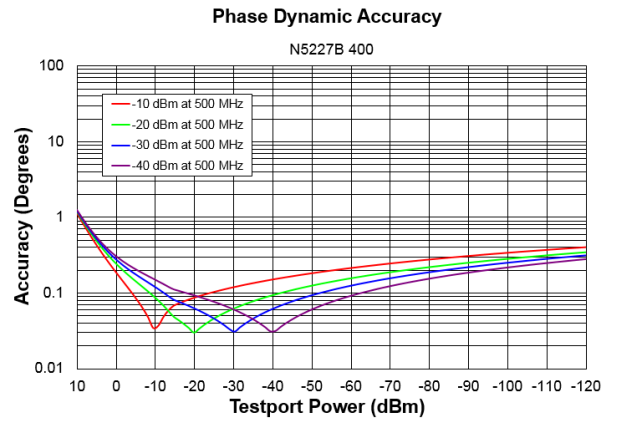
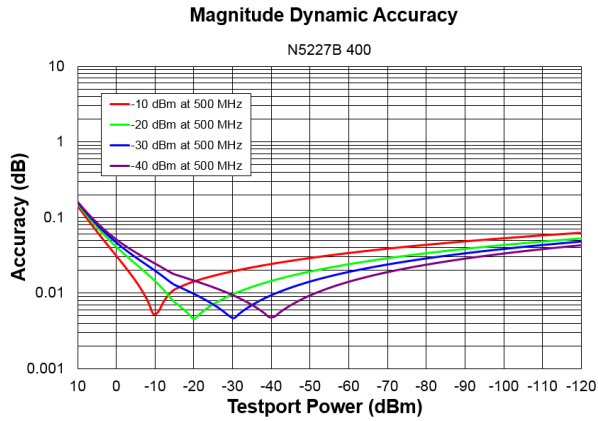

## N5227B Dynamic Accuracy, 1 GHz - Specification

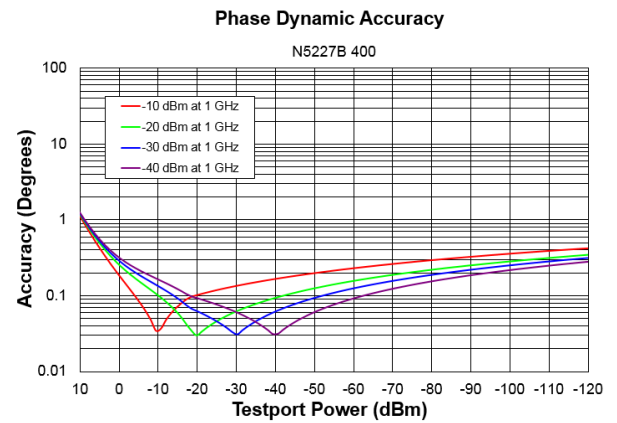
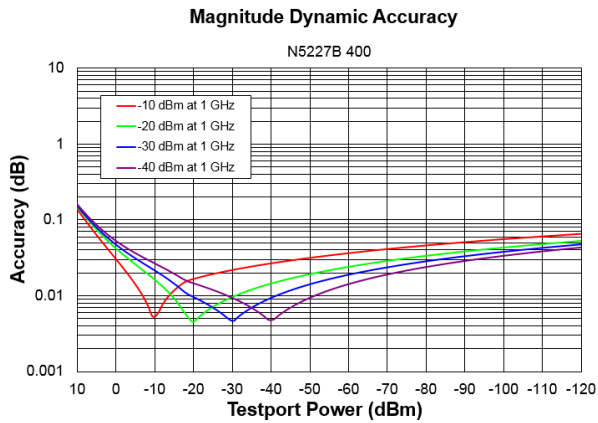

## N5227B Dynamic Accuracy, 2 GHz - Specification

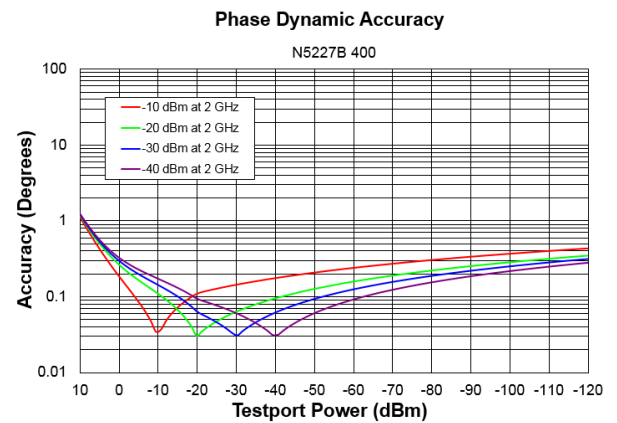
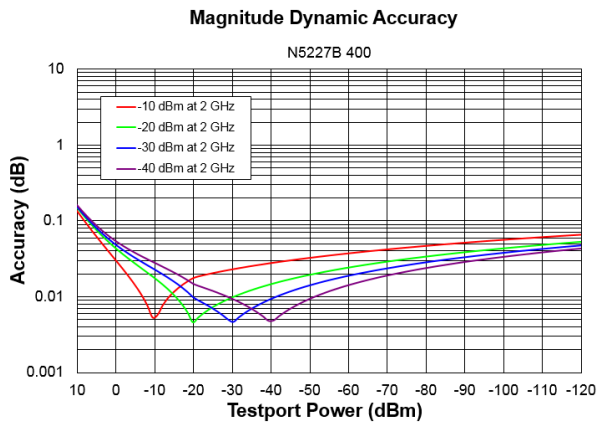

## N5227B Dynamic Accuracy, 20 GHz - Specification

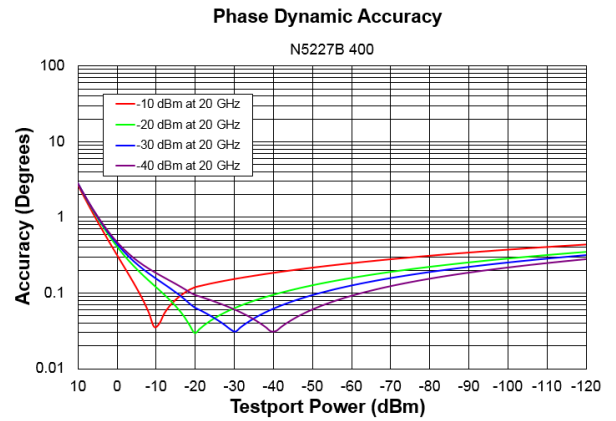
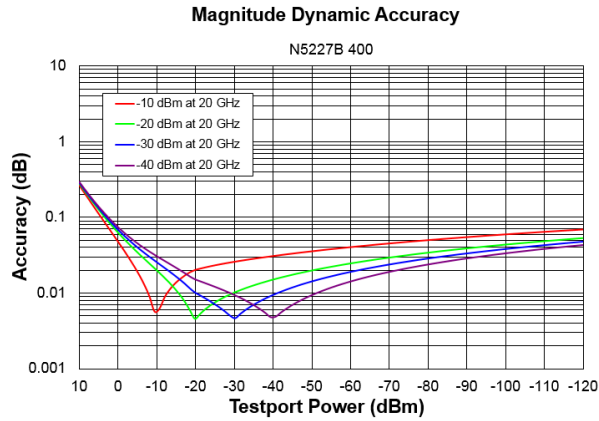

## N5227B Dynamic Accuracy, 26.5 GHz - Specification

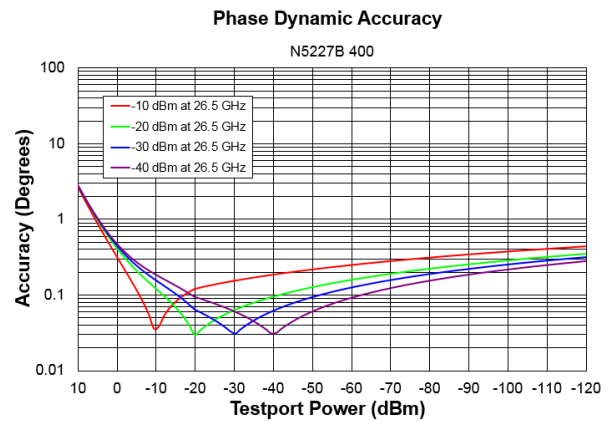
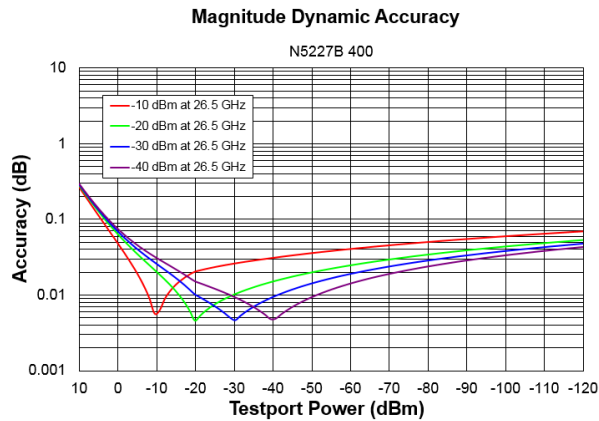

## N5227B Dynamic Accuracy, 35 GHz - Specification

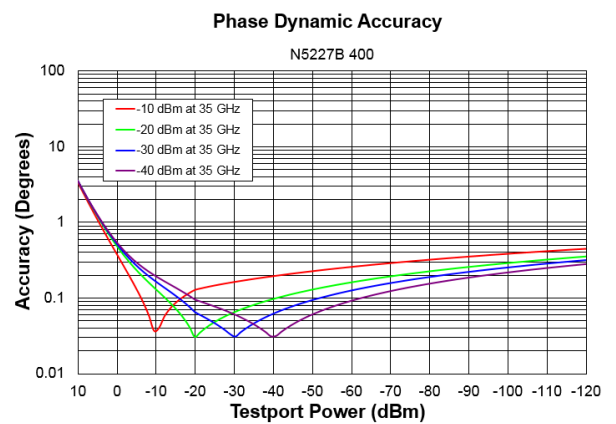
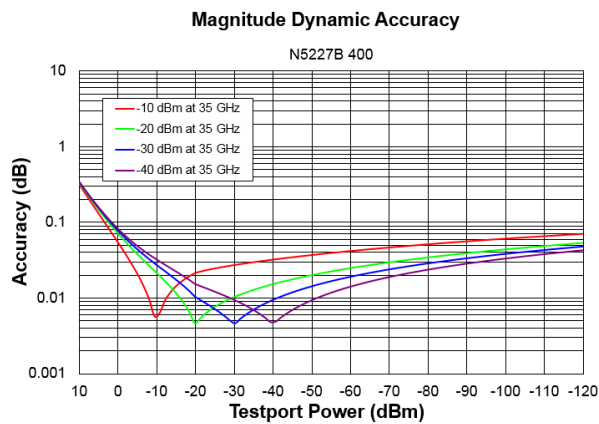

## N5227B Dynamic Accuracy, 40 GHz - Specification

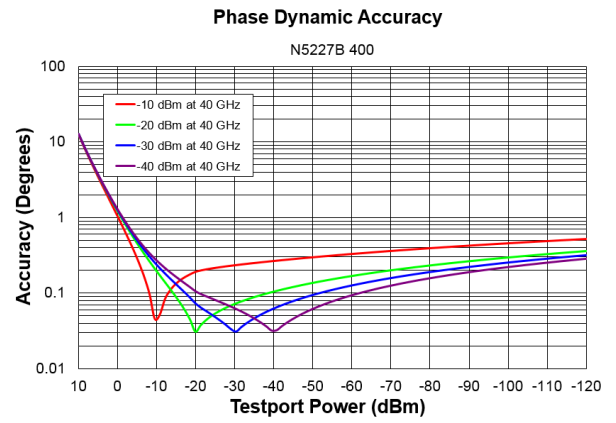
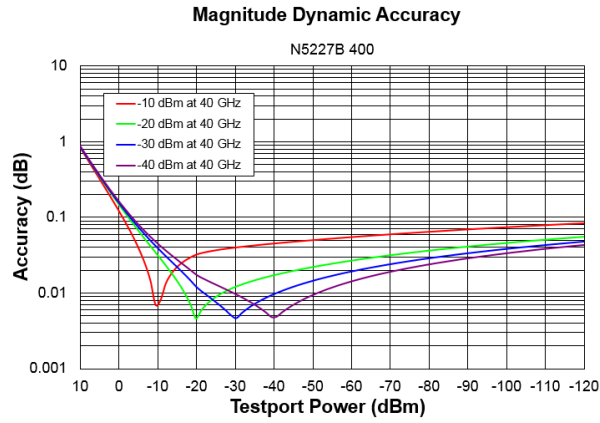

## N5227B Dynamic Accuracy, 50 GHz - Specification

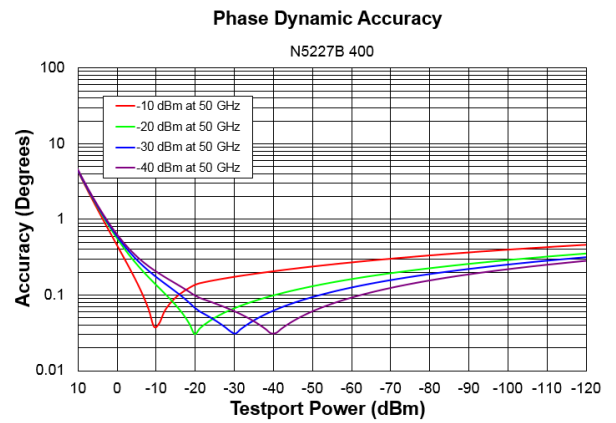
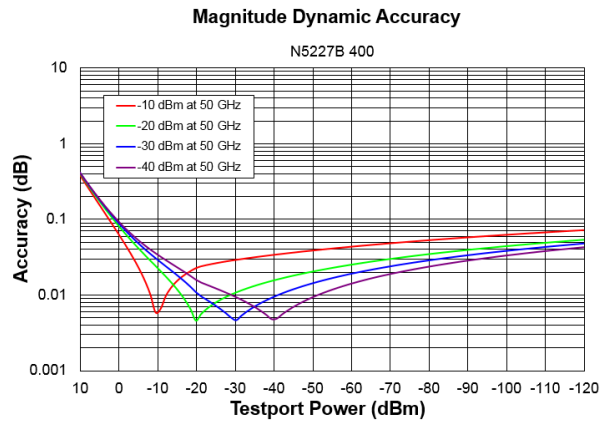

## N5227B Dynamic Accuracy, 60 GHz - Specification

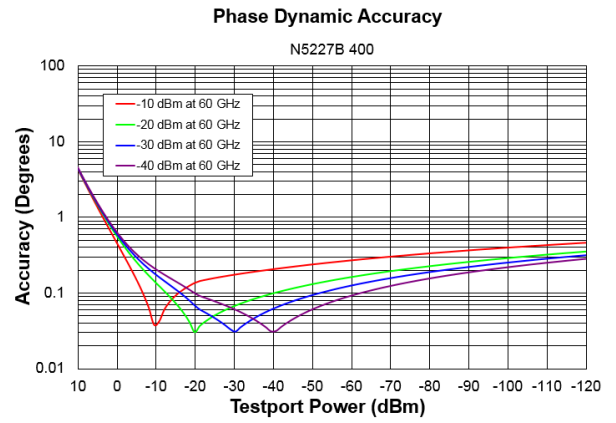
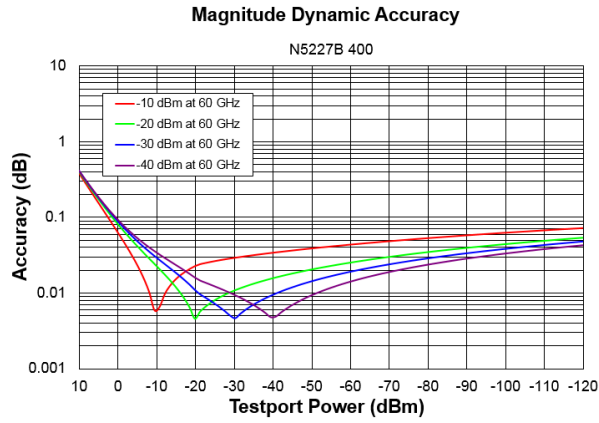

## N5227B Dynamic Accuracy, 67 GHz - Specification

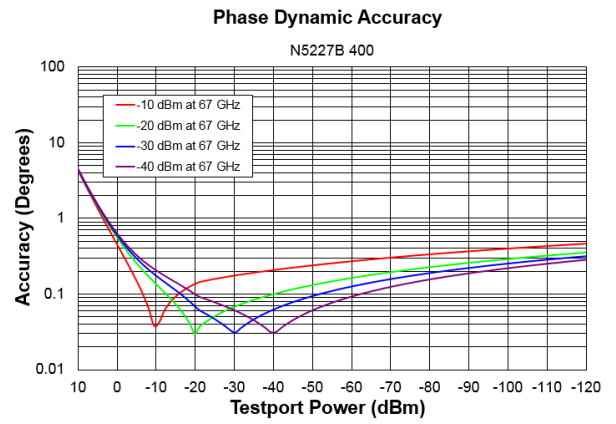
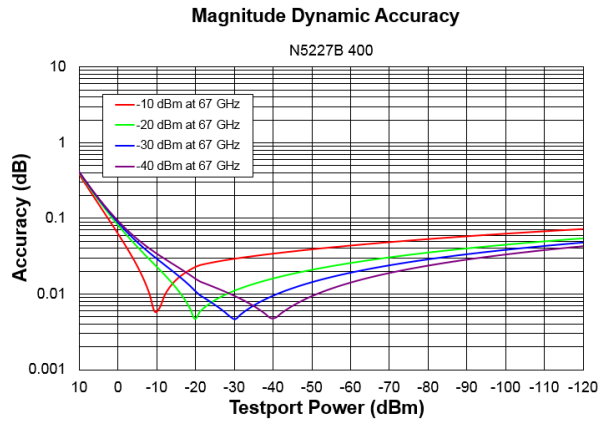



**Table 25. Group Delay - Typical**

Group delay is computed by measuring the phase change within a specified frequency step (determined by the frequency span and the number of points per sweep). In general, the following formula can be used to determine the accuracy, in seconds, of specific group delay measurement:

$$\pm \text{Phase Accuracy (deg)} / [360 \times \text{Aperture (Hz)}]$$

Depending on the aperture and device length, the phase accuracy used is either incremental phase accuracy or worst-case phase accuracy

Description	Typical Performance
Aperture (selectable)	(frequency span)/(number of points -1)
Maximum Aperture	20% of frequency span
Range	0.5 x (1/minimum aperture)
Maximum Delay	Limited to measuring no more than 180° of phase change within the minimum aperture.)

The following graph shows characteristic group delay accuracy with full 2-port calibration and a 10 Hz IF bandwidth. Insertion loss is assumed to be < 2 dB and electrical length to be ten meters.

For any  $S_{ij}$  Group Delay measurement,  $S_{ii} = 0$ ,  $S_{ij} = 1$ ,  $S_{ji} = 0$ ,  $S_{kl} = 0$  for all  $kl \neq ij$

### Group Delay Accuracy (Typical)

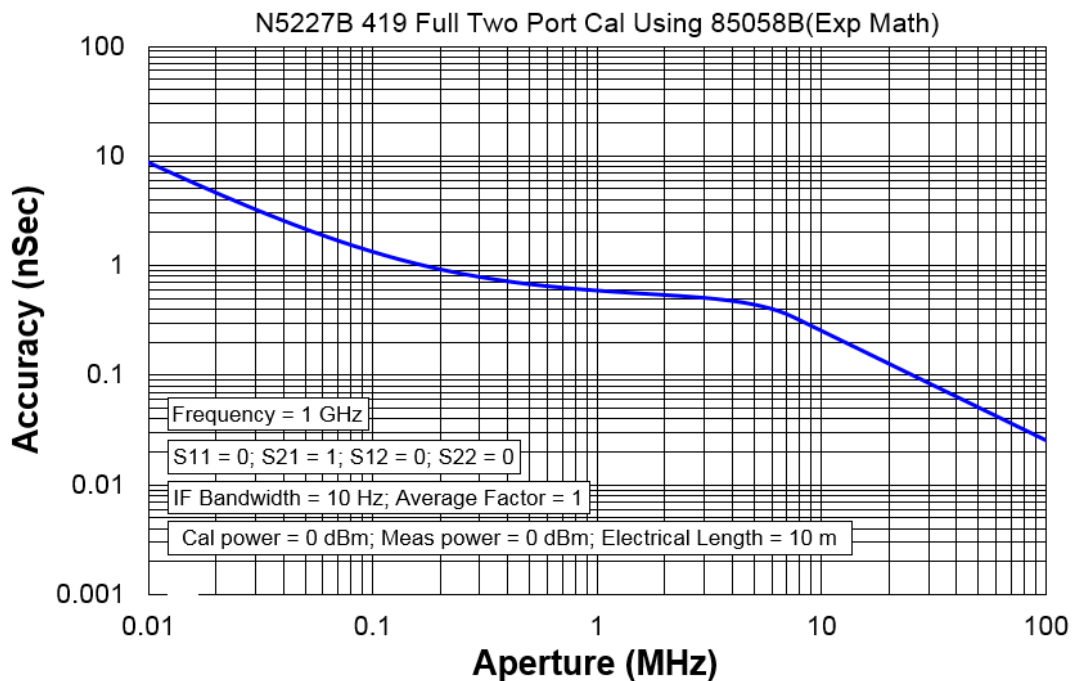

## General Information

- [Miscellaneous Information](#)
- [Front Panel](#)
- [Rear Panel](#)
- [Environment and Dimensions](#)

Table 26. Miscellaneous Information

Description	Supplemental Information
System IF Bandwidth Range	1 Hz to 15 MHz, nominal
CPU	For the latest information on CPUs and associated hard drives, visit: <a href="http://na.support.keysight.com/pna/hdnumbers.html">http://na.support.keysight.com/pna/hdnumbers.html</a>
LXI	Class C

Table 27. Front Panel Information, All Options

Description	Typical Performance
<b>RF Connectors</b>	
Type	1.85 mm (male), 50 ohm, (nominal)
Center Pin Recession	0.002 in. (characteristic)
<b>USB 2.0 Ports - Master (4 ports)</b>	
Standard	Compatible with USB 2.0
Connector	USB Type-A female
<b>Display</b>	
Size	31 cm (12.1 in) diagonal color active matrix LCD; 1280 (horizontal) X 800 (vertical) resolution
Refresh Rate	Vertical 60 Hz; Horizontal 49.31 kHz
Pixels	Any of the following would cause a display to be considered faulty: <ul style="list-style-type: none"> <li>• A complete row or column consists of “stuck” or “dark” pixels.</li> <li>• More than six “stuck on” pixels (but not more than three green) or more than 0.002% of the total pixels are within the LCD specifications.</li> <li>• More than twelve “dark” pixels (but no more than seven of the same color) or more than 0.004% of the total pixels are within the LCD specifications.</li> <li>• Two or more consecutive "stuck on" pixels or three or more consecutive "dark" pixel (but no more than one set of two consecutive dark pixels).</li> <li>• “Stuck on” pixels or more than two “dark” pixels less than 6.5 mm apart (excluding consecutive pixels).</li> </ul>

Table 27. (Continued) Front Panel Information, All Options

Description	Typical Performance
<b>Display Range</b>	
Magnitude	±2500 dB (at 500 dB/div), max
Phase	±2500° (at 500 degrees/div), max
Polar	10 pUnits, min 10,000 Units, max
<b>Display Resolution</b>	
Magnitude	0.001 dB/div, min
Phase	0.01°/div, min
<b>Marker Resolution</b>	
Magnitude	0.001 dB, min
Phase	0.01°, min
Polar	10 pUnit, min

Table 28. Rear Panel Information, All Options

Description	Typical Performance
<b>10 MHz Reference In</b>	
Connector	BNC, female
Input Frequency	10 MHz ± 10 ppm
Input Level	-15 dBm to +20 dBm
Input Impedance	200 Ω, nom.
<b>10 MHz Reference Out</b>	
Connector	BNC, female
Output Frequency	10 MHz ± 1 ppm
Signal Type	Sine Wave
Output Level	+10 dBm ± 4 dB into 50 Ω
Output Impedance	50 Ω, nominal
Harmonics	<-40 dBc, typical

Table 28. (Continued) Rear Panel Information, All Options

Description	Typical Performance
<b>External IF Inputs</b>	
Function	Allows use of external IF signals from remote mixers, bypassing the PNA's first converters
Connectors	SMA (female); A, B, C, D, R (4-port); A, B, R1, R2 (2-port)
Input Frequency	
Normal IF path	RF < 53 MHz: IF = 826.446 KHz RF >= 53 MHz: IF = 7.438 MHz
Narrowband IF path	IF = 10.70 MHz
Input Impedance	50 $\Omega$
RF Damage Level	+23 dBm
DC Damage Level	5.5 VDC
0.1 dB Compression Point	
Normal IF path	-9.0 dBm at 7.438 MHz
Narrowband IF path	-17 dBm at 10.70 MHz
<b>Pulse Inputs (IF Gates)</b>	
Function	Internal receiver gates used for point-in-pulse and pulse-profile measurements
Connectors	15-pin mini D-sub
Input Impedance	1 K Ohm
Minimum Pulse Width, Source Modulators	33 ns
Minimum Pulse Width, Receiver Gates	20 ns
DC Damage Level	5.5 VDC
Drive Voltage	0 V (off), +3.3 V (on), nominal
<b>RF Pulse Modulator Input (Source Modulator)</b>	
<b>On/Off Ratio</b>	
10 MHz to 3.2 GHz	-64
3.2 GHz to 67 GHz	-80
<b>Pulse Period</b>	
Minimum	33 ns
Maximum	70 s

Table 28. (Continued) Rear Panel Information, All Options

Description	Typical Performance	
<b>Pulse Outputs</b>		
Voltage (TTL)	High: 3.3V to 3.5V Low: <1V	
Impedance	50 Ohm	
<b>External Test Set Driver</b>		
Function	Used for driving remote mixers	
Connections	3.5 mm (female)	
RF Output Frequency Range	3.2 GHz to 19 GHz	
LO Output Frequency Range	0.01 GHz to 26.5 GHz	
<b>Rear Panel LO Power<sup>1</sup></b>		
	<b>Upper Limit, Typical (dBm)</b>	<b>Lower Limit, Typical (dBm)</b>
1.7 GHz to 16 GHz	5	-3
16 GHz to 21 GHz	0	-6
21 GHz to 26.5 GHz	4	-5
<b>Rear Panel RF1/RF2 Power</b>		
	<b>Maximum Output Power, Typical (dBm)</b>	
3.2 GHz to 5 GHz	+3	
5 GHz to 19 GHz	+8	
<b>Devices Supported</b>	<b>Resolutions</b>	
Flat Panel (TFT)	1024 X 768, 800 X 600, 640 X 480	
Flat Panel (DSTN)	800 X 600, 640 X 480	
CRT Monitor	1280 X 1024, 1024 X 768, 800 X 600, 640 X 480	
Simultaneous operation of the internal and external displays is allowed, but with 640 X 480 resolution only. If you change resolution, you can only view the external display (internal display will "white out").		

<sup>1</sup> LO output available in full analyzer's frequency range. The power is tested only from 3.2 GHz to 26.5 GHz.

Table 28. (Continued) Rear Panel Information, All Options

Description	Typical Performance
<b>Bias Tee Inputs</b>	
Connectors	BNC(f) for ports 1, 2, 3 and 4
Fuse	500 mA, bi-pin style
Maximum Bias Current	±200 mA with no degradation of RF specifications
Maximum Bias Voltage	±40 VDC
Trigger Inputs/Outputs	BNC(f), TTL/CMOS compatible
Test Set IO	25-pin D-Sub connector, available for external test set control.
Power IO	9-pin D-Sub, female; analog and digital IO
Handler IO	36-pin parallel I/O port; all input/output signals are default set to negative logic; can be reset to positive logic via GPIB command.
Pulse I/O	15-pin D connector provides access to Pulse Modulators and Generators
GPIB	Two ports - dedicated controller and dedicated talker/listener. 24-pin D-sub (Type D-24), female; compatible with IEEE-488.
PCIe	Cabled PCIe x4 connector is a 4-lane slot (not currently used)
USB Ports	Two SuperSpeed USB ports (900 mA each), one USB port below LAN connector, and one USB device port. There are also four USB ports (500 mA each) on the front panel. The total current limit for all rear panel USB ports is 2.3 amps. The total current limit for all front panel USB ports is 2 amps.
LAN	10/100/1000 BaseT Ethernet, 8-pin configuration; auto selects between the data rates
VGA Video Output	15-pin mini D-Sub; Drives VGA compatible monitors
Mini DisplayPort	Miniature DisplayPort connector for connection to external displays
<b>Line Power</b>	
Frequency, Voltage	50/60/400 Hz for 100 to 120 VAC 50/60 Hz for 220 to 240 VAC
	Power supply is auto switching
Max	450 watts

Table 29. Analyzer Dimensions and Weight

All models are shipped with handles.

Cabinet Dimensions	Metric (mm)	Imperial (inches)
<b>Height</b>		
Without bottom feet: <sup>1</sup> EIA RU = 6	266.1	10.5
With bottom feet	279.1	11.0
<b>Width</b>		
Without handles or rack-mount flanges	425.6	16.8
With handles, without rack-mount flanges	458.7	18.1
With handles and rack-mount flanges	482.9	19.0
<b>Depth</b>		
Without front and rear panel hardware	582.3	22.9
With front and rear panel hardware, handles	649.6	25.6

<sup>1</sup> Electronics Industry Association rack units. 1 RU = 1.75 in.

See detailed PNA dimension drawings at: <http://na.support.keysight.com/pna/PNADimensions.pdf>

Weight (nominal)	Net	Shipping
All 2-port models	42.2 kg (93 lb)	57.6 kg (127 lb)
All 4-port models	44.9 kg (99 lb)	60.3 kg (133 lb)

### Regulatory and Environmental Information

For Regulatory and Environmental information, refer to the PNA Series Installation and Quick Start Guide, located online at <http://literature.cdn.keysight.com/litweb/pdf/E8356-90001.pdf>.

## Measurement Throughput Summary

- Typical Cycle Time for Measurement Completion
- Cycle Time vs. IF Bandwidth
- Cycle Time vs. Number of Points
- Data Transfer Time

Cycle time Includes sweep time, retrace time and band-crossing time. Analyzer display turned off with DISPLAY:ENABLE OFF. Add 21 ms for display on. Data for one trace (S<sub>11</sub>) measurement. LF Auto BW off.

Table 30. Typical Cycle Time (ms) for Measurement Completion, All Models and Options

Sweep Range	IF Bandwidth		Number of Points				
			201	401	1601	16001	32001
50 kHz to 100 MHz	10kHz	Uncorrected	75	141	515	4726	9243
		2-Port cal	155	285	1050	9505	18440
	1kHz	Uncorrected	306	599	2339	23000	46003
		2-Port cal	611	1200	4715	46185	91960
	100Hz	Uncorrected	2543	5085	20293	202691	405085
		2-Port cal	5120	10200	40640	405200	809800
9 GHz to 10 GHz	600 kHz	Uncorrected	2.6	2.9	7.1	56.1	110
		2-Port cal	5.8	6.5	14.6	112	220
	10 kHz	Uncorrected	28.1	54.7	205	2003	4006
		2-Port cal	67.2	117	418	4028	8062
	1 kHz	Uncorrected	225	444	1744	17041	33853
		2-Port cal	463	900	3500	34100	67744
10 GHz to 20 GHz	600 kHz	Uncorrected	17.7	18.3	23.9	70.2	119
		2-Port cal	34.4	36.5	47.8	141	235
	10 kHz	Uncorrected	69.5	128	259	2012	4012
		2-Port cal	146	264	528	4041	8072
	1 kHz	Uncorrected	235	459	1783	17384	34538
		2-Port cal	477	924	3575	34788	69103



Table 31. Typical Cycle Time (ms) for Full-Span Measurement Completion

10 MHz to 67 GHz		Number of Points				
		201	401	1601	16001	32001
600 kHz	Uncorrected	48	72	95.5	187	243
	2-Port cal	96.5	145	191	369	524
10 kHz	Uncorrected	89.1	153	519	2219	4223
	2-Port cal	185	313	1042	4448	8462
1 kHz	Uncorrected	255	483	1834	17716	35172
	2-Port cal	515	972	3675	35444	70375

Table 32. Cycle Time vs. IF Bandwidth - Typical

Applies to the Preset condition (201 points, correction off) except for the following changes:

- CF = 10 GHz
- Span = 100 MHz
- Display off (add 21 ms for display on)

Cycle time includes sweep and retrace time.

Description		N5227B	
IF Bandwidth (Hz)	Cycle Time (ms)	Trace Noise Magnitude (dB rms)	
600,000	2.11	0.0044	
100,000	3.18	0.0021	
30,000	6.8	0.0011	
10,000	26.45	0.0007	
3,000	68.79	0.0006	
1,000	219	0.0004	
300	637	0.0004	
100	1821	0.0003	
30	5978	0.0003	
10	17831	0.0003	
3	177718	0.0003	

**Table 33. Cycle Time vs. Number of Points - Typical**

Applies to the Preset condition (correction off) except for the following changes:

- CF = 10 GHz
- Span = 100 MHz
- Display off (add 21 ms for display on)

Cycle time includes sweep and retrace time.

Description	IF Bandwidth (Hz)			
	Number of Points	1,000	10,000	30,000
3	4.84	2.17	1.88	1.56
11	13.75	4.45	2.81	1.48
51	57.27	7.73	2.71	1.64
101	111.41	13.96	4.06	1.88
201	218.75	26.45	6.78	2.11
401	431.8	51.48	11.84	2.89
801	854.61	101.09	21.88	4.38
1,601	1694.92	200.65	42.19	7.29
6,401	6682.81	797.27	162.5	23.44
16,001	16562.5	1992.19	404.95	52.08
32,001	32882.81	3976.56	796.88	109.38

**Table 34. Data Transfer Time (ms) - Typical**

Measured with the analyzer display off.

Values will increase slightly if the analyzer display is on.

Description	Number of Points				
	201	401	1601	16,001	32,001
<b>SCPI over GPIB</b> (Program executed on external PC <sup>2</sup> )					
32-bit floating point	4.6	9.3	38	352	720
64-bit floating point	9.4	18.8	73.4	730	1455
ASCII	36.7	72.5	288	2882	5762
<b>SCPI over SICT/LAN or TCP/IP Socket</b> <sup>1</sup> (Program executed in the analyzer)					
32-bit floating point	<1	<1	<1	1.2	2.4
64-bit floating point	<1	<1	<1	2.3	4.6
ASCII	2.1	4	15	148	295
<b>COM</b> <sup>1</sup> (Program executed in the analyzer)					
32-bit floating point	<1	<1	<1	<1	<1
Variant type	<1	<1	1.4	12.4	25.5
<b>DCOM over LAN</b> <sup>1</sup> (Program executed on external PC)					
32-bit floating point	<1	<1	<1	2.3	4.4
Variant type	<1	1.6	5.3	52	105.5

<sup>1</sup> Values are for real and imaginary pairs, with the analyzer display off, using Gigabit Ethernet.

**NOTE** Specifications for Recall & Sweep Speed are not provided for the N522xB analyzers.

## Specifications: Front-Panel Jumpers



The following options have front-panel jumpers for each port:

201, 205, 219, 220, 401, 405, 419, 420

- Measurement Receiver Inputs
- Port 1 Reference Receiver Inputs and Reference Source Outputs
- Port 2, 3, 4 Reference Receiver Inputs and Reference Source Outputs
- Source Outputs
- Coupler Inputs
- Damage Level

Table 35. Measurement Receiver Inputs (dBm) - Typical

(RCVR A, B, C, D IN) @ 0.1dB Typical Compression

Description	N5227B
10 MHz to 500 MHz	-3
500 MHz to 3.2 GHz	-4
3.2 GHz to 26.5 GHz	-5
26.5 GHz to 50 GHz	-4
50 GHz to 64 GHz	-3
64 GHz to 67 GHz	-4
67 GHz to 70 GHz	-2

Table 36. Port 1 Reference Receiver Inputs and Reference Source Outputs (dBm) - Typical

(RCVR R1 IN, REF 1 SOURCE OUT) @ Max Specified Output Power

Description	Option 201, 401	Option 219, 419
10 MHz to 50 MHz	-30	-30
50 MHz to 500 MHz	-16	-16
500 MHz to 1 GHz	-9	-9
1 GHz to 2 GHz	-6	-5
2 GHz to 3.2 GHz	-10	-11
3.2 GHz to 10 GHz	-8	-9
10 GHz to 16 GHz	-10	-11
16 GHz to 26.5 GHz	-11	-12
26.5 GHz to 30 GHz	-13	-14
30 GHz to 32 GHz	-16	-16
32 GHz to 35 GHz	-14	-15
35 GHz to 40 GHz	-17	-14
40 GHz to 70 GHz	-12	-14

Table 37. Port 2, 3, 4 Reference Receiver Inputs and Reference Source Outputs (dBm) - Typical

(RCVR R2 IN, RCVR R3 IN, RCVR R4 IN, REF 2 SOURCE OUT, REF 3 SOURCE OUT, REF 4 SOURCE OUT) @ Max Specified Output Power

Description	Option 201, 401	Option 401	Option 219, 419	Option 419
	RCVR R2 IN, RCVR R4 IN, REF 2 SOURCE OUT, REF 4 SOURCE OUT	RCVR R3 IN, REF 3 SOURCE OUT	RCVR R2 IN, RCVR R4 IN, REF 2 SOURCE OUT, REF 4 SOURCE OUT	RCVR R3 IN, REF 3 SOURCE OUT
10 MHz to 50 MHz	-25	-25	-25	-25
50 MHz to 500 MHz	-6	-6	-10	-10
500 MHz to 1 GHz	-4	-4	-4	-4
1 GHz to 2 GHz	-1	-1	-1	-1
2 GHz to 3.2 GHz	-5	-1	-6	-1
3.2 GHz to 10 GHz	-1	-1	-2	-2
10 GHz to 16 GHz	-3	-3	-4	-4
16 GHz to 26.5 GHz	-4	-4	-4	-4
26.5 GHz to 30 GHz	-4	-4	-5	-5
30 GHz to 32 GHz	-6	-6	-7	-7
32 GHz to 35 GHz	-4	-4	-5	-5
35 GHz to 40 GHz	-8	-8	-9	-9
40 GHz to 50 GHz	-2	-2	-4	-4
50 GHz to 60 GHz	-1	-1	-3	-3
60 GHz to 64 GHz	0	0	-2	-2
64 GHz to 67 GHz	1	1	-3	-3
67 GHz to 70 GHz	0	0	-1	-1

**Table 38. Source Outputs (dBm) - Typical**

(PORT 1 SOURCE OUT, PORT 2 SOURCE OUT, PORT 3 SOURCE OUT, PORT 4 SOURCE OUT) @ Max Specified Output Power

Description	Option 201, 401		Option 219, 419	
	PORT 1 SOURCE OUT PORT 3 SOURCE OUT	PORT 2 SOURCE OUT PORT 4 SOURCE OUT	PORT 1 SOURCE OUT PORT 3 SOURCE OUT	PORT 2 SOURCE OUT PORT 4 SOURCE OUT
10 MHz to 50 MHz	12	12	11	11
50 MHz to 1 GHz	13	13	13	13
1 GHz to 2 GHz	14	14	14	14
2 GHz to 3.2 GHz	11	14	10	14
3.2 GHz to 10 GHz	14	14	12	13
10 GHz to 16 GHz	13	13	11	11
16 GHz to 26.5 GHz	13	13	10	10
26.5 GHz to 30 GHz	12	12	10	10
30 GHz to 32 GHz	9	9	8	8
32 GHz to 35 GHz	11	11	9	9
35 GHz to 40 GHz	7	7	5	5
40 GHz to 60 GHz	13	13	12	12
60 GHz to 64 GHz	14	14	13	13
64 GHz to 70 GHz	14	14	12	12

Table 39. Coupler Inputs (dB) - Typical

(PORT 1, 2, 3, 4 CPLR THRU) Insertion Loss of Coupler Thru

Description	Option 201, 401	Option 219, 419
10 MHz to 50 MHz	0	0
50 MHz to 500 MHz	-0.25	-0.25
500 MHz to 1 GHz	-0.5	-0.5
1 GHz to 2 GHz	-0.5	-1.0
2 GHz to 3.2 GHz	-0.75	-1.0
3.2 GHz to 10 GHz	-1.0	-1.5
10 GHz to 16 GHz	-1.2	-2.0
16 GHz to 26.5 GHz	-1.8	-2.5
26.5 GHz to 35 GHz	-2.0	-3.0
35 GHz to 40 GHz	-2.5	-4.0
40 GHz to 50 GHz	-3.0	-6.0
50 GHz to 60 GHz	-3.6	-7.2
60 GHz to 64 GHz	-3.8	-7.7
64 GHz to 67 GHz	-4.0	-8.0
67 GHz to 70 GHz	-4.2	-8.4

Table 40. Damage Level, All Options - Typical

Description	RF (dBm)	DC (V)
RCVR A, B, C, D IN	15	7
RCVR R1, R2, R3, R4 IN	15	7
REF 1 SOURCE OUT	15	7
REF 2, 3, 4 SOURCE OUT	30	7
PORT 1, 2, 3, 4 SOURCE OUT	27	7
PORT 1, 2, 3, 4 CPLR THRU	27 (20 <sup>1</sup> )	40 (50 <sup>1</sup> )
PORT 1, 2, 3, 4 CPLR ARM	30	7

<sup>1</sup> With an LFE option installed.



# Test Set Block Diagrams

**NOTE**

For best readability, use a color printer for printing the following graphics.

## Legend

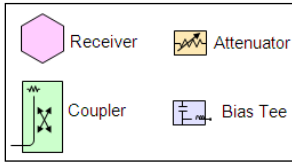

N5227B Option 200 (2-port base model)

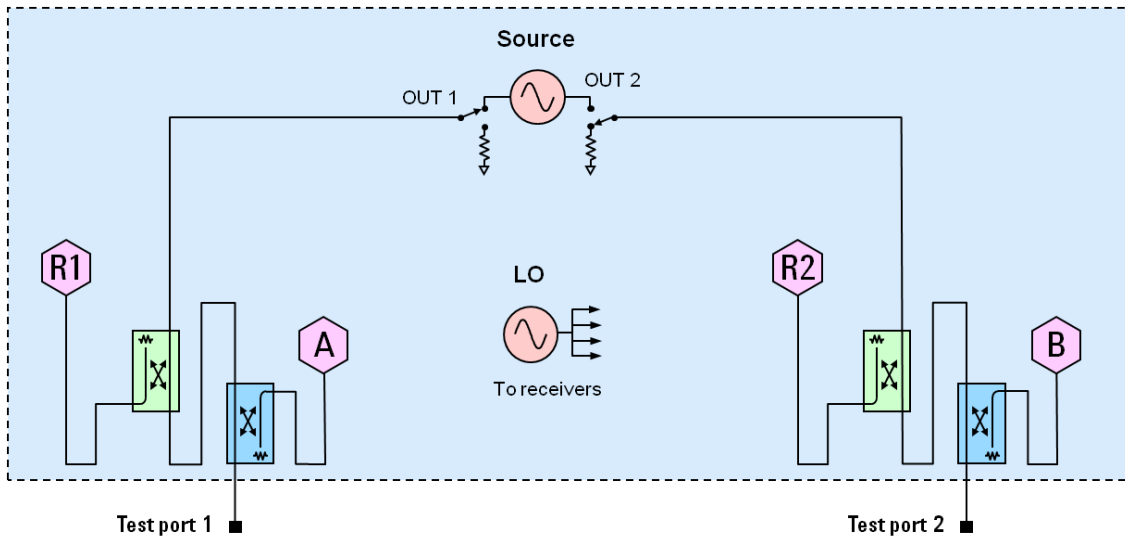

## N5227B Option 201

To base model, adds front-panel jumpers and R1 receiver switch

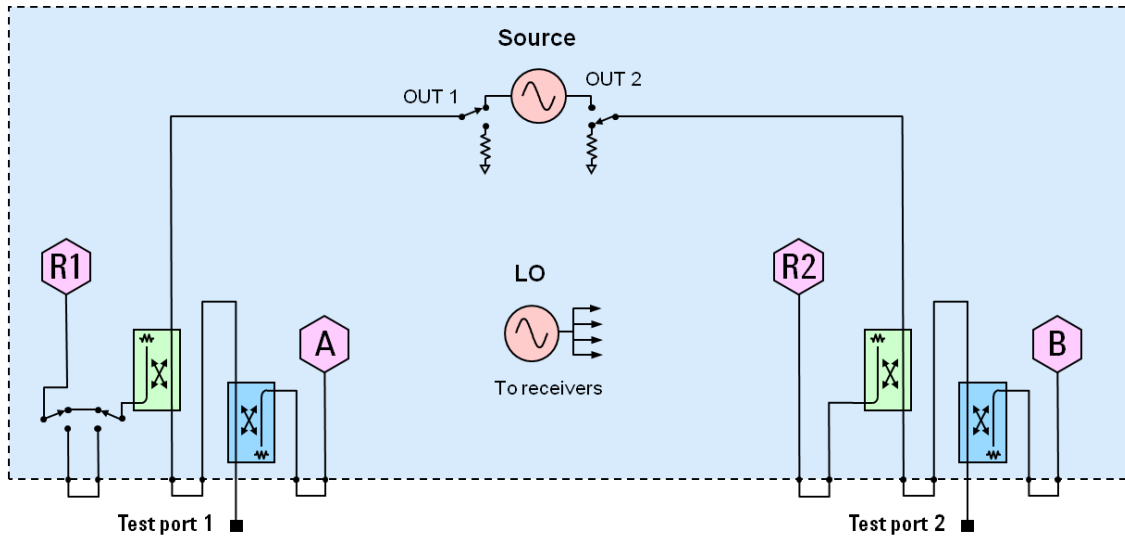

## N5227B LFE Options

The following LFE block diagram shows how the low-frequency hardware is configured for a single test port. The other ports are configured similarly.

**NOTE** The attenuators do not apply to Options 205 and 405.

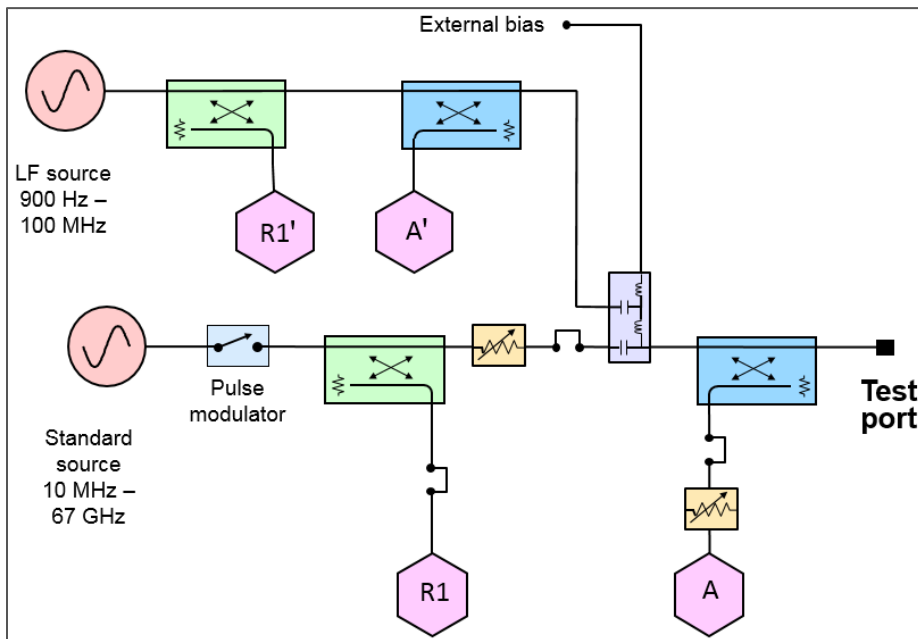

### N5227B Option 219

To base model, adds front-panel jumpers, R1 receiver switch, source and receiver attenuators (extended power range), and bias-tees.

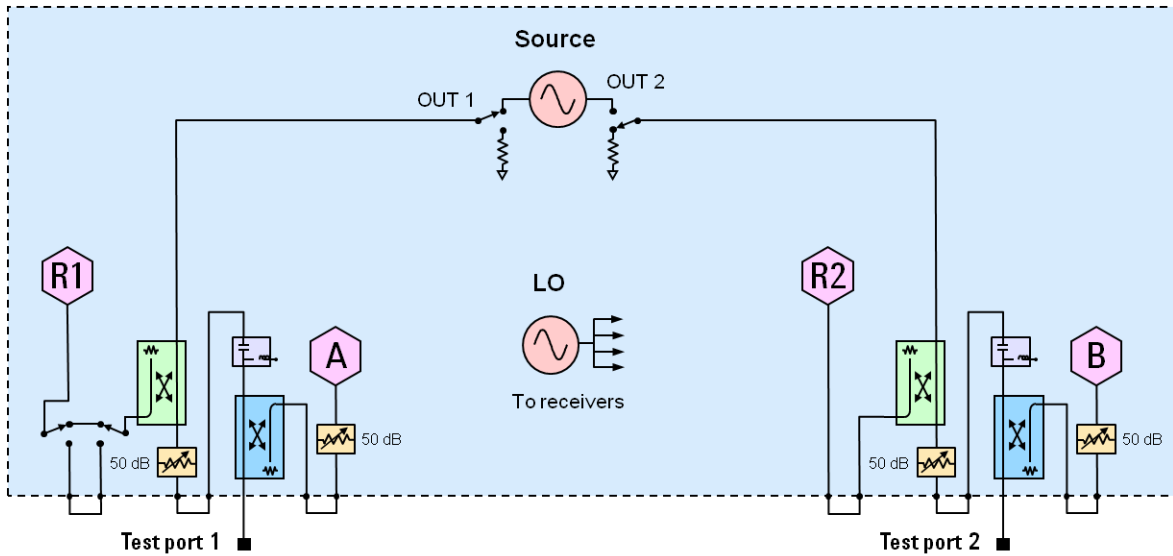

### N5227B Option 400 (4-port base model)

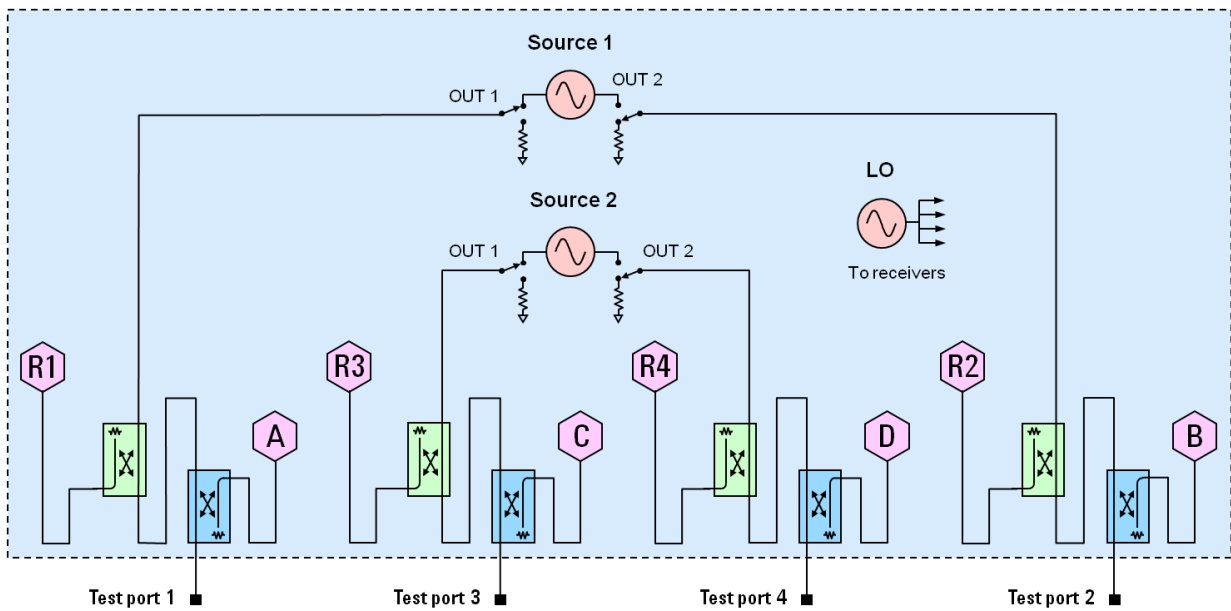

### N5227B Option 401

To base model, adds front-panel jumpers and R1 receiver switch

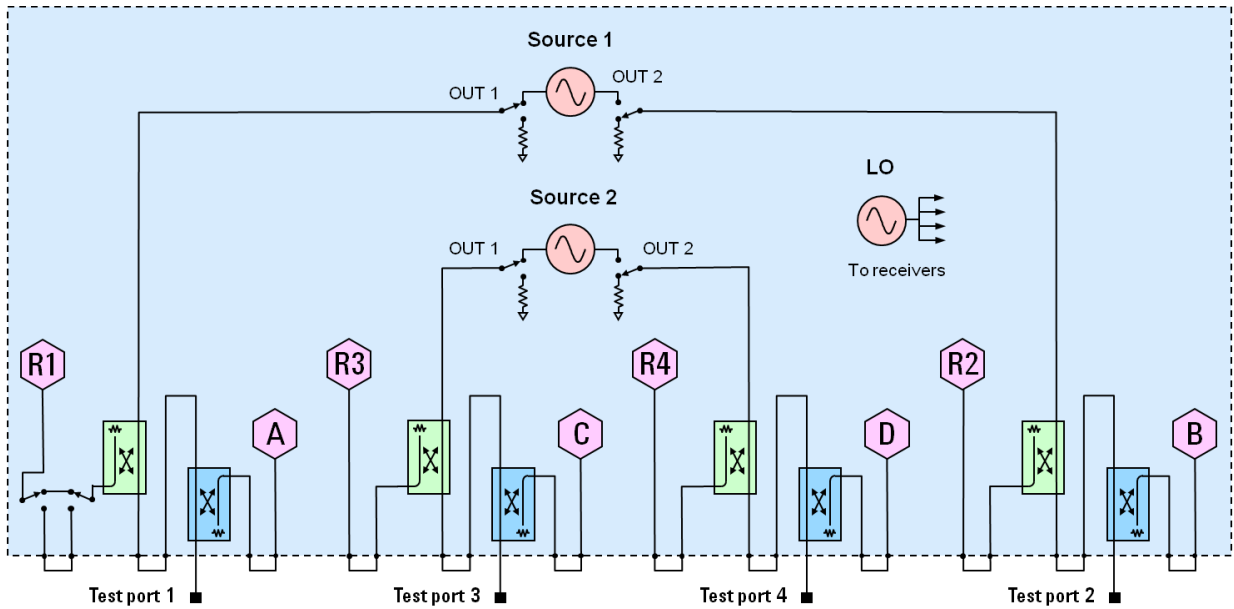

### N5227B Option 419

To base model, adds front-panel jumpers, R1 receiver switch, source and receiver attenuators (extended power range), and bias-tees.

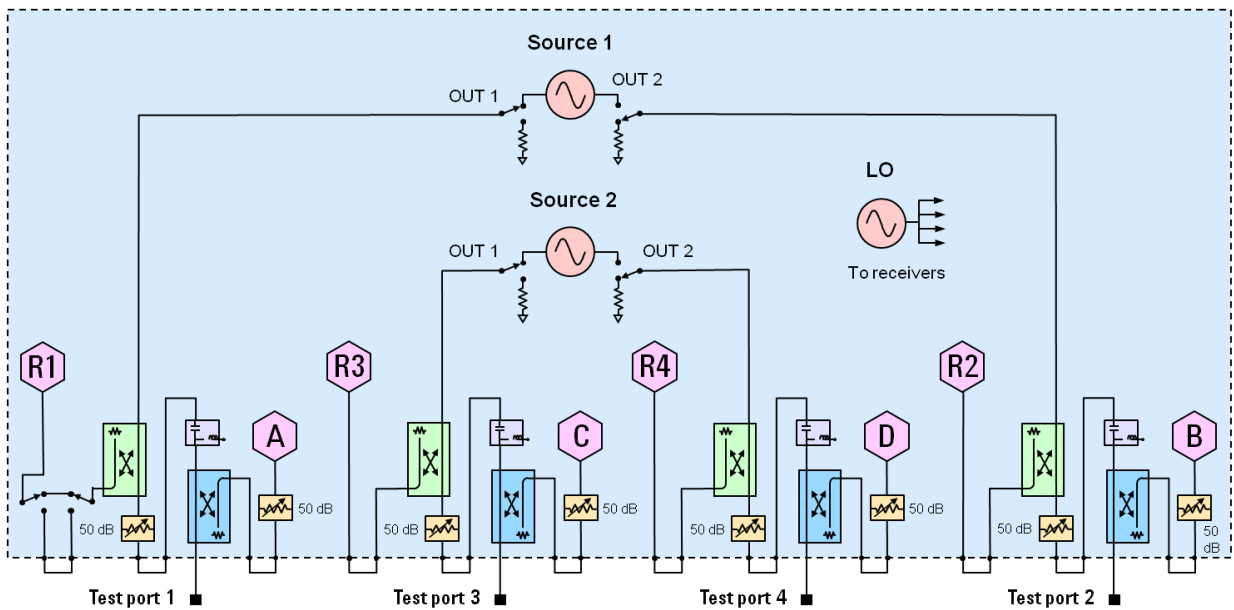

# Receiver Block Diagram

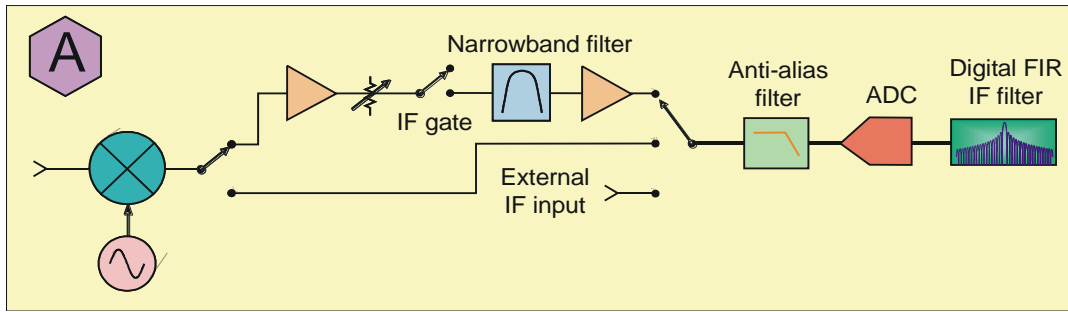



This information is subject to change without notice.  
© Keysight Technologies 2017-2020  
Print Date: March 10, 2020



N5227-90005

[www.keysight.com](http://www.keysight.com)