



OLTS-85

SmartClass™ Fiber

User's Guide

BN 2325/98.21

2016.01

English

Please direct all inquiries to your local Viavi sales company. The addresses can be found at:

www.viavisolutions.com/en-us/contact-sales-expert

A description of additional instrument features can be found at:

www.viavisolutions.com/en-us/products/network-test-and-certification

Notice

Every effort was made to ensure that the information in this document was accurate at the time of printing. However, information is subject to change without notice, and Viavi reserves the right to provide an addendum to this document with information not available at the time that this document was created.

General Public License

This product includes Qt 4.8.3 software licensed under the GNU LGPL v. 2.1, and barebox 2012.02.0 and linux 3.1.0-rc8 software licensed under the GNU GPL v. 3. To request a copy of the source code for this software, please write to:

Open Source Request • Viavi Legal Department •
430 N. McCarthy Blvd. • Milpitas, CA 95035 USA

Copyright

© Copyright 2016 Viavi Solutions Inc. All rights reserved. Viavi and the Viavi logo are trademarks of Viavi Solutions Inc.

All other trademarks and registered trademarks are the properties of their respective owners.

Viavi Solutions Deutschland GmbH
Arbachtalstraße 5, D-72800 Eningen u. A.

Order no.: BN 2325/98.21

Version: 2016.01

Previous version: 2015.11

Notes:

Changes may be made to specifications, descriptions, and delivery information.

CONTENTS

- INTRODUCTION 5**
 - OLTS-85 Loss Test Set 5
 - OLTS-85 Light Sources 6
 - Operating manual update 7
 - Symbols used in this operating manual 8

- SAFETY INFORMATION 10**
 - Warning symbols on the unit 10
 - Proper usage 10
 - Laser safety 11
 - Battery operation 11
 - Ventilation 12
 - PS4 Universal AC/DC Power Supply 12

- GETTING STARTED 14**
 - Unpacking the instrument 14
 - Connecting optical cables 21

- BASIC OPERATION 23**
 - Switching the instrument on/off 23
 - Operator control panel 23
 - Display elements 24
 - Navigating in the menus 25
 - Getting help and information 25
 - Configuring the instrument 26
 - Software options 30

- TIER 1 LOSS TEST OPERATION 32**
 - Tier 1 Loss Test 32
 - Referencing methods 37
 - Pass/Fail indication 45

- POWERMETER OPERATION 46**
 - General information 46
 - Powermeter measurement 46

- LASER OPERATION 51**
 - General information 51
 - Selecting a laser source 53
 - Auto λ feature 53
 - Selecting a mode 54

Setting the power level	56
Switching on/off the laser	57
PROBE/PCM OPERATION	58
General information	58
Patch Cord Microscope (PCM)	58
FMAE series adapters for the PCM	59
Features available with the P5000i Digital Probe	59
QuickCapture™ key	61
File toolbar	61
Configuring the Digital Probe	62
MEMORY MANAGEMENT	66
General information	66
Selecting the project to save or display results	68
Saving results	68
Displaying stored results	70
Using the Link Data Mode	71
Clearing the memory	72
MAKING A REPORT	74
MAINTENANCE	75
Cleaning the test port	75
Cleaning the instrument	75
SPECIFICATIONS	77
General specifications	77
Power meter specifications	78
Light Source specifications	78
Tier 1 specifications	79
Patch cord microscope specifications	79
ORDERING INFORMATION	80
OLTS-85 Optical Loss Test Set	80
Included items	80
Accessories	81

1 INTRODUCTION

OLTS-85 Loss Test Set

The SmartClass™ Fiber OLTS-85 (optical loss test set) contains high-performance, easy-to-use instruments with a two or four wavelength light source and a power meter. They are universal instruments for Tier 1 certification of single-mode and multi-mode fibers, installation, maintenance, and troubleshooting. Automate pass/fail end-face analysis for all fiber types, and gain complete test visibility at both local and remote ends. Use pre-configured cabling specifications from all leading manufacturers.

Loss can be measured simultaneously at two wavelengths. Quick referencing for all built-in wavelengths can be effected independent of the current measurement mode.

Key Benefits of the OLTS-85 Loss Test Set

- Achieve complete network certification with the OLTS-85.
- Optimize productivity with the industry's fastest test workflow.
- Obtain comprehensive results for the latest TIA 568.3, ISO 11801, and ISO 14763-3 requirements.
- View test setup and results data and edit labels at both local and remote ends.
- Objective pass/fail testing for fiber end-face requirements.

Features

- Multi-mode (850/1300 nm) and single-mode (1310/1550 nm) adapters for Tier 1 fiber certification (loss/length/polarity).
- Industry-leading P5000i Digital Probe fiber end-face inspection probe support.

OLTS-85 Light Sources

The SmartClass™ Fiber OLTS-85 light sources are professional, versatile, compact handheld instruments designed for qualification and certification of fiber optic networks. Carefully chosen combinations of available wavelengths make SmartClass™ Fiber OLTS-85 light sources the optimum choice for link loss testing and characterization of long-haul, metro, and access telecommunication networks, as well as for data center and local area network testing.

Single-mode (SM) and multi-mode (MM) – The all-in-one solution

OLTS-85 devices that have both single-mode and multi-mode light sources are the most flexible test instruments. These instruments are particularly suitable for rental and measurement service companies.

Fiber inspection ready – Inspect before you connect

The SmartClass™ Fiber OLTS-85 instruments are prepared for fiber inspection. Connection of a P5000i Digital Probe to the OLTS-85 enables a technician to perform best practices fiber inspection and automated Pass/Fail testing of optical connectors/adapters in order to ensure industry standard fiber endface quality and cleanliness.

No additional fiber microscope set required – simply plug in a P5000i Digital Probe.

Report generation – Do it the easy way

Of course, it is possible to make measurement reports with a PC tool.

FiberChekPRO is the ideal tool for generating your report. Please download FiberChekPRO for free on <http://updatemyunit.net>.

Rugged and portable

Battery operation with AA dry batteries, or with a rechargeable Li-Ion Battery Pack ensure a long operating time in the field and a robust, shock-proof design makes the SmartClass™ Fiber instruments the perfect choice for optical network field testing, even under tough conditions.

Remote controllable

Operation with an AC/DC power supply and remote control capabilities via USB 2.0 and Ethernet make the SmartClass™ Fiber instruments a perfect solution even for fixed installations in central offices, in production environments, and on the laboratory workbench.

Operating manual update

Continuing enhancement and further development of the SmartClass family may mean that this operating manual does not cover all the latest functions of your instrument.

If the operating instructions about features supported by your instrument are missing, please visit the Viavi web site to check if additional information is available.

To download the latest user manual:

1. Visit the Viavi web site at <http://updatemyunit.net>.
2. Select your SmartClass™ Fiber model from the product line.
3. Open the download area and download the latest user manual.

Symbols used in this operating manual

Various elements are used in this operating manual to draw attention to special meanings or important points in the text.

Symbols and terms used in warnings

The following warnings, symbols, and terms are used in this document in compliance with the American National Standard ANSI Z535.6-2011:

NOTICE

Follow the instructions carefully to avoid **damage to or destruction of the instrument**.

CAUTION

Follow the instructions carefully to avoid a low or medium risk of **injury to persons**.

WARNING

Follow the instructions carefully to avoid **severe injury** to persons.

DANGER

Follow the instructions carefully to avoid **death or severe injury** to persons.



High voltage

Follow the instructions carefully to avoid **damage** to the instrument or **severe injury** to persons.

This safety instruction is given if the danger is due to **high voltage**.



Laser

Follow the instructions carefully to avoid **damage** to the instrument or **severe injury** to persons.

This safety instruction is given if the danger is due to **laser radiation**. Information specifying the laser class is also given.

Warning format

All warnings have the following format:

⚠ WARNING

Type and source of danger

Consequences of ignoring the warning.

- ▶ Action needed to avoid danger.

The following character formats are used in this operating manual:

√	<p>Requirement</p> <p>This requirement must be met first; e.g.</p> <p>√ The system is switched on.</p>
▶ 1. 2.	<p>Instruction</p> <p>Follow the instructions given (the numbers indicate the order in which the instructions should be followed); e.g.</p> <p>▶ Select mode.</p>
<i>Italics</i>	<p>Result</p> <p>Indicates the result of following an instruction; e.g.</p> <p><i>The page opens.</i></p>
Boldface	<p>Pages, controls, and display elements</p> <p>Screen pages, controls, and display elements are indicated in boldface.</p>
Text in blue	<p>Cross references</p> <p>Cross references are indicated in blue type. When using the PDF version, just click on the blue text to skip to the cross reference.</p>
[⏏]	<p>Instrument keys</p> <p>Instrument keys are indicated within square brackets.</p>
[More]	<p>Touchscreen buttons</p> <p>Touchscreen buttons are indicated within blue square brackets.</p>

2 SAFETY INFORMATION

Warning symbols on the unit



Warning symbols indicating a potential hazard

- ▶ In all cases where the unit is labeled with a warning symbol, the operating manual must be consulted to learn more about the nature of the potential hazard and any action that must be taken.
-

Proper usage

This instrument is intended for measurements on optical fiber devices and systems.

- ▶ Please make sure the instrument is not operated outside the permitted ambient conditions.
- ▶ Always make sure that the instrument is in proper working order before switching it on.

Laser safety



▲ WARNING

Dangerous laser radiation

Laser radiation can cause irreparable damage to eyes and skin.

This device is a Class 1 laser product according to DIN EN 60825-1:2007.

- ▶ Always be aware of the hazard level of the instrument to be connected.
 - ▶ Connect all optical fibers before switching on the radiation source.
 - ▶ Switch off the laser source before disconnecting the optical fibers.
 - ▶ Never look directly into the unconnected port of the instrument, the output of a laser source, or an optical fiber connected to a source or a system.
 - ▶ Always cover unused ports.
 - ▶ Be aware that the emitted light is not visible.
 - ▶ Heed the normal precautions for working with laser radiation and consider local regulations.
-

Battery operation

▲ WARNING

Explosion danger

Short-circuiting the batteries can result in overheating, explosion, or ignition of the batteries and their surroundings.

- ▶ Never short-circuit the battery contacts by touching both contacts simultaneously with an electrical conducting object.
 - ▶ Only use AA size dry batteries or rechargeable batteries.
 - ▶ Make sure the batteries are inserted with the correct polarity.
-

Ventilation

NOTICE

Insufficient ventilation

Insufficient ventilation can damage the instrument or adversely affect its function and safety.

- Ensure adequate ventilation when operating the instrument.
-

PS4 Universal AC/DC Power Supply

Safety class

The PS4 Universal AC/DC Power Supply unit has a protective isolation that conforms with IEC 60950.

Environmental conditions

NOTICE

Ambient temperature too high/low

Temperatures outside the operating range of 0 to +40 °C can damage the PS4 Universal AC/DC Power Supply or adversely affect its function and safety.

- Only operate the PS4 Universal AC/DC Power Supply indoors.

The PS4 Universal AC/DC Power Supply must only be operated at ambient temperatures between 0 and +40 °C.

NOTICE

Insufficient ventilation

Insufficient ventilation can damage the PS4 Universal AC/DC Power Supply or adversely affect its function and safety.

- Ensure adequate ventilation when operating the PS4 Universal AC/DC Power Supply.
-

NOTICE**Condensation**

Operation in the presence of condensation can damage the PS4 Universal AC/DC Power Supply or adversely affect its function and safety.

- ▶ Do not operate the PS4 Universal AC/DC Power Supply if condensation has formed.
 - ▶ If condensation cannot be avoided, such as when the PS4 Universal AC/DC Power Supply is cold and is moved to a warm room, wait until the PS4 Universal AC/DC Power Supply Unit is dry before plugging it into the AC power line.
-

3 GETTING STARTED

Unpacking the instrument

Packing material

We suggest that you keep the original packing material. It is designed for reuse (unless it is damaged during shipping). Using the original packing material ensures that the instrument is properly protected during shipping.

Checking the package contents

- Unpack the instrument and check the package contents. For more information see ["Included items" on page 80](#).

Checking for shipping damage

After you unpack the instrument, check to see if it was damaged during shipping. This is particularly likely if the packaging is visibly damaged. If there is damage, do not attempt to operate the instrument. Doing so can cause further damage. In case of damage, please contact your local Viavi sales company. Addresses can be found at www.viavisolutions.com.

Recovery following storage/shipping

Condensation can occur if an instrument that is stored or shipped at a low temperature is brought into a warm room. To prevent damage, wait until no more condensation is visible on the surface of the instrument before powering it up. Do not operate the instrument until it has reached its specified temperature range and wait until it has cooled down if the instrument was stored at a high temperature (see ["Ordering Information" on page 80](#)).

Instrument overview



Fig. 1 Front view OLTS-85 and OLTS-85P

- | | |
|-----------|--|
| 1 | Patch cord microscope (PCM) with FMAE adapter |
| 2 | PCM controls: focus control, automated Pass/Fail analysis, magnification control |
| 3 | Connector interface |
| 4 | Test head cover (green for APC- and gray for PC connectors) |
| 5 | 3.5 inch touchscreen |
| 6 | Key pad (operator control panel) |
| 7 | Battery compartment and stand (on rear of instrument) |
| 8 | USB 2.0 device port (Type Micro-B) |
| 9 | USB 2.0 host port (Type A) and external power supply connector |
| 10 | Ethernet port (RJ-45) |

Connector panel

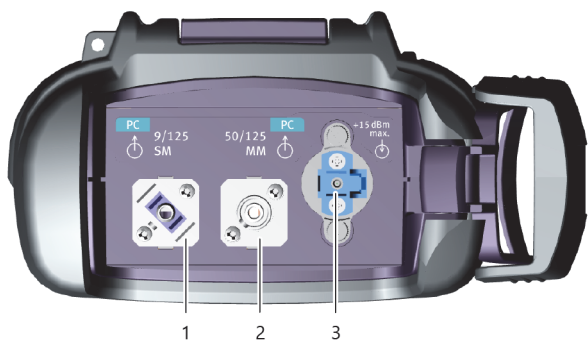

Fig. 2 Connector panel

-
- 1 Optical connector 1, single-mode

 - 2 Optical connector 2, multi-mode

 - 3 Input port for broadband measurement

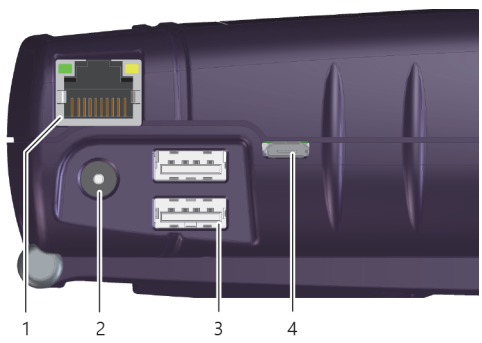

Fig. 3 External power supply connector and communication interfaces

-
- 1 Ethernet port (RJ-45)

 - 2 External power supply connector

 - 3 USB 2.0 host port (Type A)

 - 4 USB 2.0 device port (Type Micro-B)

Power supply

The following power sources can be used to operate the OLTS-85:

- Eight 1.5 V dry batteries (Mignon AA size, alkaline type recommended)
- Eight 1.2 V NiMH rechargeable batteries (Mignon AA size, no internal charge)
- PS4 Universal AC/DC Power Supply (optional)
- RBP2 Li-Ion Battery Pack (optional)

Battery operation

▲ WARNING

Dangers when handling batteries

Handling batteries may be dangerous. Please note the following safety instructions.

- ▶ Please note the battery operation safety information in the chapter “[Battery operation](#)” on page 11.

Replacing batteries

- ▶ Do not replace individual batteries. Always change all eight batteries at the same time.
- ▶ Always use eight batteries of the same type; i.e. do not mix rechargeable and non-rechargeable batteries.

Replacing batteries



Fig. 4 Replacing the batteries

- | | |
|---|--------------------------|
| 1 | RBP2 Li-Ion Battery Pack |
| 2 | Latch lock |
| 3 | AA battery tray |

The battery compartment is on the back of the instrument.

1. Press down the latch to release and to open the lid of the battery compartment.
2. Insert new batteries or remove the used batteries and replace them with fresh ones.

NOTICE: Take care to insert the batteries correctly. The correct polarity is indicated by a diagram inside the battery compartment.

– or –

1. Press down the latch lock to release the battery tray.
2. Insert the RBP2 Li-Ion Battery Pack.
3. Close the battery compartment.
4. Press the [⏻] key to switch on.

Recharging the batteries

The rechargeable RBP2 Li-Ion Battery Pack recharges when the PS4 Universal AC/DC Power Supply is used to power the instrument. The instrument switches to trickle charging automatically as soon as the RBP2 Li-Ion Battery Pack is fully charged.

Note: Rechargeable AA batteries will not be recharged in the instrument. For AA-type rechargeable batteries please use an external charger.

It is not possible to charge the rechargeable AA batteries or the RBP2 Li-Ion Battery Pack via the USB interface.

If the PS4 Universal AC/DC Power Supply and the USB interface are both connected, the instrument is powered by the PS4 Universal AC/DC Power Supply.

General tips on using batteries

- Always handle batteries with care.
- Do not drop or damage the batteries or expose them to excessively high temperatures.
- Do not store the batteries for more than one or two days at very high temperatures (e.g. in a vehicle), either separately or inserted in the instrument.
- Do not leave discharged batteries in the instrument for a long time if it is not being used.

Other basic safety precautions are as follows:

- Do not use PS4 Universal AC/DC Power Supply outdoors or in wet or damp locations.
- Connect the PS4 Universal AC/DC Power Supply to the correct mains voltage, as indicated on the rating label.
- Do not allow anything to rest on the power cord, and do not place the product where people can walk on the power cord.
- Avoid using this product during electrical storms. There may be a remote risk of electric shock from lightning.
- Do not use this product in the vicinity of a gas leak or in any explosive environment.
- Do not attempt to service this product yourself, as opening or removing covers may expose you to dangerous, high-voltage points, and other hazards. Contact qualified service personnel for all service.

Environmental protection

Please dispose of any unwanted dry batteries and rechargeable batteries carefully. They should also be removed from the instrument if it is to be discarded. If facilities in your country exist for collecting such waste or for recycling, please make use of these rather than throwing the batteries out with normal trash. You will often be able to return used batteries to the place where you purchase new ones. Any dry or rechargeable batteries that you purchased from Viavi can be returned to one of our Service Centers for disposal.

Operation with AC power

NOTICE: Only the PS4 Universal AC/DC Power Supply may be used to operate the OLTS-85 with AC power.

To fit the AC line plug adapter:

1. Select the appropriate AC line plug adapter.
2. Slide the AC line plug adapter into the slot.
The PS4 Universal AC/DC Power Supply is ready for use.

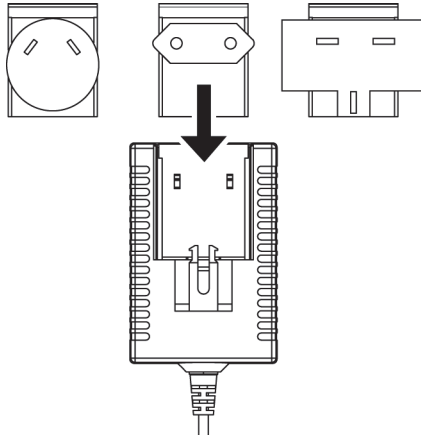

Fig. 5 PS4 Universal AC/DC Power Supply

To change the AC line plug adapter:

1. Squeeze both sides of the PS4 latch lock (see Fig. 5).
2. Push the AC line plug adapter upwards.
3. Slide a different AC line plug adapter into the slot (see Fig. 6).

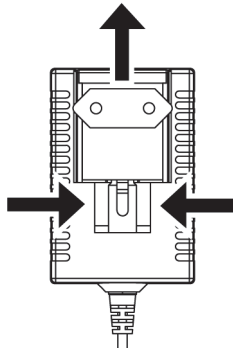

Fig. 6 PS4: Changing the AC line plug adapter

To operate the OLTS-85 with AC power:

1. Connect the PS4 DC power cord to the OLTS-85 external power supply connector.
(The connector is under the cover on the right side.)
2. Plug the PS4 into the AC line socket.
The OLTS-85 switches on automatically when powered by the PS4.

Note: The PS4 provides power even if dry or rechargeable batteries are inserted in the instrument.
The OLTS-85 cannot be powered via the USB interface.

Connecting optical cables

Mounting test adapters

Viavi provides a number of test adapters for connecting the OLTS-85 to the interface to be tested.

You can connect all standard optical connector types to the instrument using these adapters. The test adapters are suitable for connectors with planar (PC) and angled end surfaces (APC). Contact your local Viavi sales company for available adapter types.

The OLTS-85 connector type must match the cable connector type:

PC: BN 2325/01/05, BN 2326/01/05

The PC/APC versions are easily identified by the colors of the name labels on the front:

- PC = blue
- APC = green

To mount the SENKO test adapter:

- ✓ The optical connectors are properly cleaned (see “Cleaning the test port” on page 75).
- 1. Open the head cover and remove the protective cap (if still mounted).
- 2. Unscrew the SENKO test adapter and pull it off vertically.
- 3. Place the SENKO test adapter vertically on the optical connector.
- 4. Fix the SENKO test adapter with two screws.
- 5. Repeat the procedure if the instrument is equipped with two ports.
- 6. Fit the fiber optic cable to the test adapter or close the head cover.

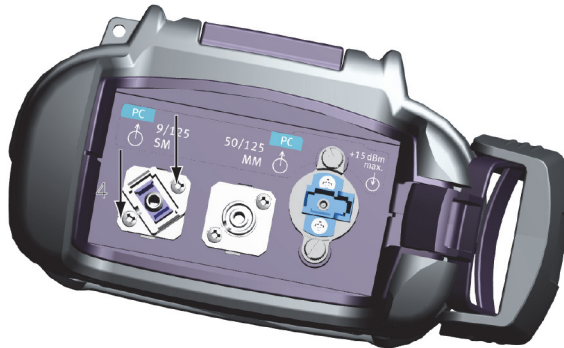

Fig. 7 Mounting the SENKO test adapter

4 BASIC OPERATION

Switching the instrument on/off











To switch the instrument on:

- ▶ Press the [⏻] key to switch on the instrument.

To switch the instrument off:

- ▶ Press the [⏻] key to shift the instrument into hibernate mode.
 - or –
- 1. Hold the [⏻] key to open the power off menu.
- 2. Tap the [Power Off] button to switch off the instrument.











Operator control panel

	Press to go to the homescreen.
	Press to open menu.
	Press to go back within an application or cancel input.
	Press to toggle between the inspect view and the test view.
	Press to switch the instrument on and off. LED glows green when the instrument is on.
	Press an arrow key to: <ul style="list-style-type: none"> • Navigate through the menus • Change values in the menus Press the centered key to: <ul style="list-style-type: none"> • Confirm the selection
	Press to save results.
	Glows red when battery is low.
	Glows red when a measurement is running in the background.
	Glows orange when battery is charged; flashes orange when battery is charging. Turned off when dry batteries are used or battery bay is empty.

Display elements



Fig. 8 Homescreen

	<p>Link Data Mode</p> <p>The saved results of any application are assigned to a dedicated project and FiberID.</p>
	<p>Auto-Off</p> <p>Indicates whether the instrument turns off within a certain time.</p>
	<p>External power supply</p> <p>The OLTS-85 is powered by the external AC adapter when this symbol is shown.</p>
	<p>Battery status</p> <p>Indicates the battery charge status. If it is not shown, only the AC adapter is active.</p>
	<p>Active laser source</p> <p>Indicates when the built-in laser source is active.</p>
	<p>Tier 1 Test</p> <p>To determine the total amount of loss or attenuation of a fiber link.</p>
	<p>Powermeter</p> <p>To install and maintain cables and networks with the broadband power meter.</p>
	<p>Source</p> <p>To edit the laser for maintenance and characterization of single-mode and multi-mode networks.</p>
	<p>Probe</p> <p>To view and inspect the bulkhead (female) connectors.</p>
	<p>Patch Cord Microscope (only BN 2326)</p> <p>To view and inspect the patch cord connector of the fiber.</p>

Navigating in the menus

- ▶ Press the [≡] key to open the context-sensitive menu.
Depending on which application is in the foreground, a different menu opens.

To select a menu item:

1. Press the arrow keys to highlight an item.
2. To confirm, press the center key within the arrow keys.
 - or –
 - Tap the desired button on the touchscreen.

To leave a menu without making any changes:

- ▶ Press the [↶] key.

Note: All actions can be operated via the operator control panel or the touchscreen. The following instructions describe only touchscreen operation.

To toggle between different display modes:

- ▶ Tap the display to toggle between the display modes (context-sensitive).

Getting help and information

- √ The homescreen is displayed.
- 1. Press the [≡] key and tap the [Help] button.
- 2. To show the instrument's operating manual, tap the [Manual] button.
 - or –
 - To show information about calibration, software, and hardware, tap the [Info] button.

To navigate through the manual:

- √ The manual is displayed.
- 1. Press the [≡] key.
- 2. To resize the displayed content, tap the [Zoom in] button, the [Zoom out] button, or the [Default Zoom] button.
 - or –
 - To go to the previous or next page, tap the [Back] or [Forward] button.

Configuring the instrument

This chapter describes the configuration of the **System Settings**.

System Settings menu overview

- ✓ The homescreen is displayed.
- ▶ Press the [≡] key and tap the [Settings] button.
The **System Settings** menu opens:

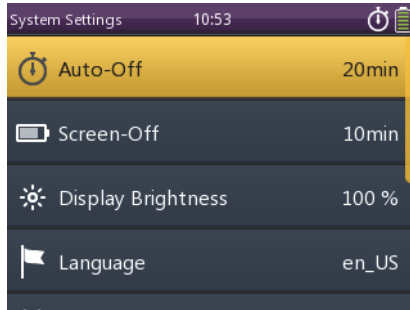

The following table gives a short overview of the menu items. These are explained in the sections below.

Auto-Off	To adjust the switch-off period of the instrument.
Screen-Off	To adjust the switch-off period of the screen.
Display Brightness	To adjust the display brightness.
Language	To select the language of the instrument texts.
Date & Time	To adjust the date, date format, time, and to set 24-hour time or 12-hour time.
Date	To adjust the date.
Date Format	To adjust the date format.
Time	To adjust the time.
Time Format	To set 24-hour time or 12-hour time.
Ethernet	To set the communications protocols.
IP Mode	To select either static or DHCP Ethernet mode.
IP Address	To set the IP-address in static Ethernet mode.
Gateway	To set the gateway in static Ethernet mode.
Netmask	To set the netmask in static Ethernet mode.
MAC Address	Unique identifier assigned to network interfaces for communication on the physical network segment.

Remote Control Port	Shows the TCP port used for remote control via Ethernet.
Wifi	To configure the wireless local area networks.
Factory Reset	Set the instrument parameters and settings to their default values as defined by Viavi. This does not affect any stored measurement results.

Changing the Auto-Off setting

- ✓ The instrument is switched on.
- 1. Press the [≡] key and tap the [Settings] button.



- 2. Tap the [Auto-Off] button.
The power mode menu opens.
- 3. Select the desired setting to change the power mode.

Changing the Screen-Off setting

- 1. Press the [≡] key and tap the [Settings] button.
- 2. Tap the [Screen-Off] button.
- 3. Select the desired setting to change the screen off time.

Note: **Auto-Off** and **Screen-Off** settings are only active when no external power supply is connected.

Adjusting the display brightness

- 1. Press the [≡] key and tap the [Settings] button.
- 2. Tap the [Brightness] button.
- 3. Type in the desired brightness value.
- 4. Tap the [OK] button.

Selecting a language

- 1. Press the [≡] key and tap the [Settings] button.
- 2. Tap the [Language] button.
The language menu opens:



3. Tap the language you want to select.
– or –
Press the arrow keys to highlight the language you want to select and to confirm press the center key within the arrow keys.

Setting the date

1. Press the [≡] key and tap the [Settings] button.
2. Tap the [Date & Time] button.
3. Tap the [Date] button.
4. To change the setting, tap the [Day], [Month], or [Year] button.
5. Type in the desired value.
6. Tap the [OK] button.

Setting the date format

1. Press the [≡] key and tap the [Settings] button.
2. Tap the [Date & Time] button.
3. Tap the [Date Format] button.
4. To change the setting, tap the desired date format.

Setting the time

1. Press the [≡] key and tap the [Settings] button.
2. Tap the [Date & Time] button.
3. Tap the [Time] button.
4. To change the setting, tap the [Hour], [Minute], or [Second] button.
5. Type in the desired value.
6. Tap the [OK] button.

Setting 24-hour or 12-hour time

1. Press the [≡] key and tap the [Settings] button.
2. Tap the [Date & Time] button.
3. Tap the [Time Format] button.
4. To change the setting, tap the desired time format.

Selecting the IP mode

1. Press the [≡] key and tap the [Settings] button.
2. Tap the [Ethernet] button.
3. Tap the [IP Mode] button.
4. Tap the Ethernet mode you want to select.

Setting the IP address

- √ The IP mode **Static** is selected.
1. Press the [≡] key and tap the [Settings] button.
 2. Tap the [Ethernet] button.
 3. Tap the [IP Address] button.
 4. Type in the desired IP address.
 5. Tap the [OK] button.

Setting the gateway

- √ The IP mode **Static** is selected.
1. Press the [≡] key and tap the [Settings] button.
 2. Tap the [Ethernet] button.
 3. Tap the [Gateway] button.
 4. Type in the desired gateway.
 5. Tap the [OK] button.

Setting the Wifi

1. Press the [≡] key and tap the [Settings] button.
2. Tap the [Wifi] button.
3. Press the [≡] key and tap the desired setting.

Resetting to the factory default values

1. Press the [≡] key and tap the [Settings] button.
2. Tap the [Factory Reset] button.

Note: Setting the factory default values does not affect your stored measurement results.

Updating the firmware

The latest version of the firmware can be downloaded from the Internet.

To find the latest firmware version:

1. Visit the Viavi web site at <http://updatemyunit.net>.
2. Select your model from the product line.
3. Open the download area and download the latest firmware.
4. Unzip and save the firmware to the root of a USB flash drive.

To update the downloaded firmware:

- ✓ The instrument is fully charged or the PS4 Universal AC/DC Power Supply is connected.
 - ✓ The instrument is switched off and not in hibernate mode.
1. Press and hold down the [≡] key.
 2. Press the [⊙] key to switch the instrument on.
The firmware update screen appears.
 3. Release the [≡] key.
 4. Plug the USB flash drive into one of the instrument USB ports.
 5. To start the firmware update procedure, press the center key within the arrow keys.
If the update procedure is terminated, the instrument turns off automatically.
 6. Remove the USB flash drive.
 7. Press the [⊙] key to switch the instrument on.

Resetting the instrument

- ▶ To reset the instrument, press the [⊙] key for more than 10 seconds.
Date and time are reset and the stored measurement data remains.

Software options

To install new software options:

1. Contact your local Viavi sales company or visit the Viavi web site at www.viavisolutions.com.
2. Select a software option from the product line and order it just like an instrument.
An e-mail with the license key will be sent.
3. Save the software option to the root of a USB flash drive.
4. Plug the USB flash drive into one of the instrument USB ports.

- Press the [≡] key and tap the [Software Options] button.
The menu opens:

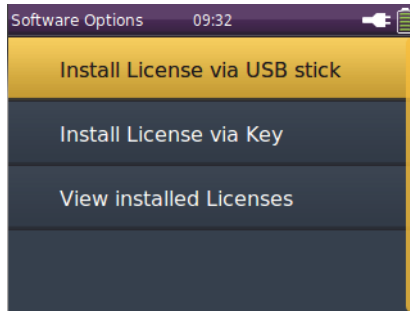

- To start the installation, tap the [Install license via USB stick] button.
– or –
To type the license key, tap the [Install license via key] button.
Successful installation or number of errors will be displayed in the following menu:

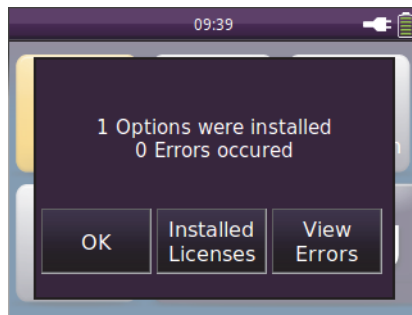

- Remove the USB flash drive.

To display the installed software options:

- ✓ The software options are installed and the confirmation menu is displayed.
 - ▶ To show the installed software options, tap the [Installed Licenses] button.
– or –
 - ✓ The homescreen is displayed.
- Press the [≡] key and tap the [Software Options] button.
 - To show the installed software options, tap the [View installed licenses] button.

5 TIER 1 LOSS TEST OPERATION

Tier 1 Loss Test

General information

The OLTS-85 offers three different measurement modes.

- **Source Mode:** The instrument works as a laser source.
- **OPM Mode:** The instrument works as an optical power meter.
- **Tier 1 Loss Test Mode:** The internal laser source and powermeter are locked. This mode is used to measure loss length and polarity of a fiber loop. For this purpose, the OLTS-85 instruments can be set and referenced as remote or local.



⚠ WARNING

Dangerous laser radiation

Laser radiation can cause irreparable damage to eyes and skin.

This device is a Class 1 laser product according to DIN EN 60825-1:2007.

- ▶ Always be aware of the hazard level of the instrument to be connected.
- ▶ Connect all optical fibers before switching on the radiation source.
- ▶ Switch off the laser source before disconnecting the optical fibers.
- ▶ Never look directly into the unconnected port of the instrument, the output of a laser source, or an optical fiber connected to a source or a system.
- ▶ Always cover unused ports.
- ▶ Be aware that the emitted light is not visible.
- ▶ Heed the normal precautions for working with laser radiation and consider local regulations.

Changing general instrument settings

For a loopback test the instrument must be set to the type **Local**. For a remote test, on the other hand, two instruments are required. One needs to be set to the type **Local**, the other to **Remote**.

Test setups can only be set on the local instrument. After connecting, the settings are transmitted to the remote instrument.

To distinguish the instruments stick adhesive labels:

Furthermore, there are adhesive labels with **Local** and **Remote** imprint, which serve to distinguish each instrument.

- ▶ Attach these adhesive labels on the designated recess of the dust cap of your instruments.



Fig. 9 **Remote/Local** adhesive labels

To change the instrument type:

✓ The instrument is in **Tier 1 Test** mode.

1. Press the [≡] key.
2. Tap the [More] button.
3. Tap the [Device Type] button and choose **Local** or **Remote**.

To select the cable type:

Each fiber has its own specific parameters. Here you can define the name, type and index of refraction of your own cable.

Only cables defined here can be selected in the Tier 1 loss test.

✓ The instrument is in **Tier 1 Test** mode.

1. Press the [≡] key.
2. Tap the [More] button.
3. Tap the [Manage Cables] button.
4. Tap the desired manufacturer and cable name.

– or –

- ▶ To add further cable types, change, or delete existing ones, press the [≡] key and tap the desired button.

To change the length unit:

✓ The instrument is in **Tier 1 Test** mode.

1. Press the [≡] key.

2. Tap the [More] button.
3. Tap the [Length Unit] button.
4. Tap the desired length unit.

To activate or deactivate the connection tone:

- ✓ The instrument is in **Tier 1 Test** mode.

 1. Press the [≡] key.
 2. Tap the [More] button.
 3. Tap the [Enable Tone] button to activate or deactivate the connection tone.

To recall stored measurement data:

For detailed information, see “Memory Management” on page 66.

To recall information relating to built-in sources:

- ✓ The instrument is in **Tier 1 Test** mode.

 1. Press the [≡] key.
 2. Tap the [More] button.
 3. Tap the [Info] button.

Changing settings for the Tier 1 loss test

Here, the setting can be made to add new, edit, or delete test setups. Each **Test Setup** can be saved under its own name. The factory setting is named **Default**.

Note: Test setups can only be created, deleted, or edited if the instrument is configured as a **Local** instrument.

The basic setting in Tier 1 loss test is the **Test Type**. The **Test Type** can be set to **Loopback** or **Remote**. Depending on your instrument hardware configuration the device can be configured for single-mode or multi-mode measurements. In **Loopback** mode you need only one instrument configured as **Local**. The measured cable pair needs to be looped with a jumper cable on the far end while in **Remote** mode the far end needs to be terminated with an OLTS-85(P) configured as **Remote**.



Fig. 10 Loopback mode und Remote mode configuration

Under **Cable Manufacturer** and **Cable Name**, the manufacturer, and used cable type is selected. This can be defined in **Manage Cables** (see “Changing general instrument settings” on page 32).

In addition, the measuring direction can be specified. In **Unidirectional**, measurements are performed in only one direction. In **Bidirectional**, both directions are measured. After the first measurement, the cables must be connected crosswise, as prompted on the touchscreen.

To select the test setup (reference method presetsings):

- ✓ The instrument is in **Tier 1 Test** mode.
- 1. Press the [≡] key.
- 2. Tap the [Test Setup] button.
- 3. Tap the desired test setup that best meets your test requirements.

To edit the test setup (reference method presetsings):

- ✓ The instrument is in **Tier 1 Test** mode.
- 1. Press the [≡] key.
- 2. Tap the [Test Setup] button.
- 3. Tap the desired test setup, press the [≡] key, and tap the [Edit] button.
 - or –
 - To copy an existing setup, press the [≡] key, and tap the [Copy] button.
 - or –
 - To create a new setup, press the [≡] key, and tap the [New] button.
- The desired test setup is selected.*
- 4. Adjust the setup settings:
 - Test Type: SM or MM and each with remote or loopback

- Cable Manufacturer
- Cable Name
- Connector: SM SC, SM LC, SM ST, MM SC, SM LC, SM ST
- Direction: unidirectional, or bidirectional
- Reference Method: 1 jumper, 2 jumper, or 3 jumper
- Limit: TIA 568.3, ISO 11801, ISO 14763-3
- Number of Connections: Specify the number of connections in the fiber system under test. Don't count the reference connections. They are already considered in the loss test calculation.
- Loss per Connection (dB): 0.1 to 0.75
- Number of Splices
- Loss per Splice (dB): 0.1 to 0.3
- Length Limit (m)
- Cable Loss

To delete the test setup (reference method presets):

- ✓ The instrument is in **Tier 1 Test** mode.
- 1. Press the [☰] key.
- 2. Tap the [Test Setup] button.
- 3. Tap the desired test setup.
- 4. Press the [☰] key.
- 5. Tap the [Delete] button.
- 6. Tap the [OK] button.

Performing a Tier 1 loss test

To perform a Tier 1 loss test generally:

- ✓ The **Device Type** of the instruments are set.
- ✓ The cable properties are stored.
- ✓ The Test Setup is set and selected (see “Referencing methods” on page 37).
- ✓ The local and remote instrument are in **Tier 1 Test** mode.
- 1. Tap the [Set Reference] button to start the reference method.
- 2. Connect the reference cords according to the touchscreen prompt.
- 3. Connect your fiber under test.
- 4. Tap the [Auto Test] button to start the loss test.
- 5. If necessary, change the cords and tap the [Continue] button as prompted.
Pass/Fail, Margin, and Length are displayed.

6. To display further information, press the [≡] key and tap the [View Detail] button, or tap the wavelength on the touchscreen.
 - ▶ To save the results, press the [F] key.

Referencing methods

For referencing, please only use the special test reference cords contained as a standard assembly in your OLTS-85 test kit.

The reference method chosen will determine how many connections are included in the loss limit.

Note: In the following procedures, test-reference jumpers are assumed to:

- be compliant to IEC 61280-4-1/4-2 in good condition
- have no end-face damage or debris

Disconnecting the connection at the transmitter of the local or remote OLTS-85 after a reference is performed invalidates the reference. Since the connection at the receiver is not glass-to-glass, it can be removed without affecting the reference. Any loss associated with the test-reference jumpers is automatically considered in the test results.

One jumper reference method

The dual-ended reference removes the losses at connection 1 and connection 4 from the measurement.

One jumper reference for single-mode fiber

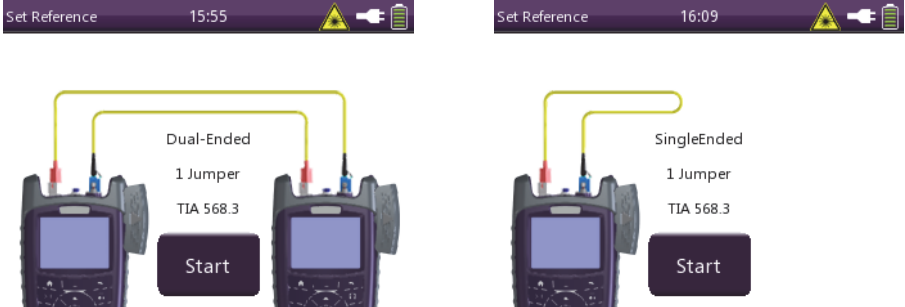

Fig. 11 One jumper reference: single-mode remote and single-mode loopback

For more information on performing a measurement refer to [Fig. 18](#).

- Reference connector to reference connector mated loss: 0.2 dB
- Reference connector to random connector: ISO 14763-3: 0.5 dB, TIA 568.3/ISO 11801: 0.75 dB
- Random to random connector: 0.75 dB
- Splice loss: 0.3 dB

$$\begin{aligned} \text{Limit}_{14763-3} &= \text{Length of fiber} * \text{Loss/km} + L_{\text{conn2}} (0.5 \text{ dB}) + L_{\text{conn3}} + L_{\text{conn4}} + \\ &L_{\text{splice5}} + L_{\text{conn6}} (0.5 \text{ dB}) \\ &= 1 \text{ dB} + \text{Length of fiber} * \text{Loss/km (dB)} + 0.75 \text{ dB} + 0.75 \text{ dB} + \\ &0.3 \text{ dB} \end{aligned}$$

$$\begin{aligned} \text{Limit}_{\text{TIA}/11801} &= \text{Length of fiber} * \text{Loss/km} + L_{\text{conn2}} (0.75 \text{ dB}) + L_{\text{conn3}} + L_{\text{conn4}} + \\ &L_{\text{splice5}} + L_{\text{conn6}} (0.75 \text{ dB}) \\ &= 1.5 \text{ dB} + \text{Length of fiber} * \text{Loss/km (dB)} + 0.75 \text{ dB} + 0.75 \text{ dB} + \\ &0.3 \text{ dB} \end{aligned}$$

One jumper reference for multi-mode fiber

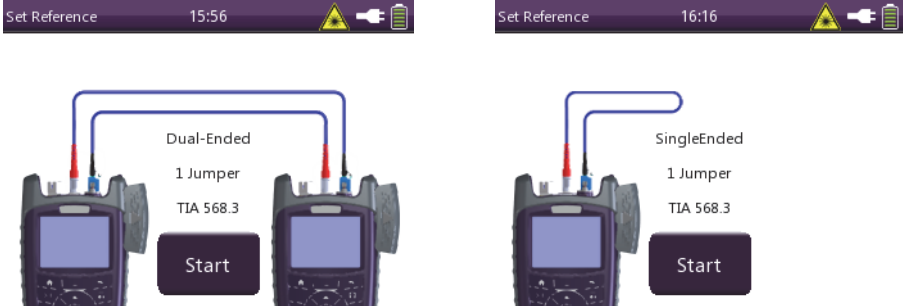

Fig. 12 One jumper reference: multi-mode remote and multi-mode loopback

For more information on performing a measurement refer to [Fig. 18](#).

Reference connector to reference connector mated loss: 0.1 dB

Reference connector to random connector: ISO 14763-3: 0.3 dB,
TIA 568.3/ISO 11801: 0.75 dB

Random to random connector: 0.75 dB

Splice loss: 0.3 dB

$$\begin{aligned} \text{Limit}_{14763-3} &= \text{Length of fiber} * \text{Loss/km} + L_{\text{conn2}} (0,3 \text{ dB}) + L_{\text{conn3}} + L_{\text{conn4}} + \\ &L_{\text{splice5}} + L_{\text{conn6}} (0.3 \text{ dB}) \\ &= 0.6 \text{ dB} + \text{Length of fiber} * \text{Loss/km (dB)} + 0.75 \text{ dB} + 0.75 \text{ dB} + \\ &0.3 \text{ dB} \end{aligned}$$

$$\begin{aligned} \text{Limit}_{\text{TIA/11801}} &= \text{Length of fiber} * \text{Loss/km} + L_{\text{conn2}} (0.75 \text{ dB}) + L_{\text{conn3}} + L_{\text{conn4}} + \\ &L_{\text{splice5}} + L_{\text{conn6}} (0.75 \text{ dB}) \\ &= 1.5 \text{ dB} + \text{Length of fiber} * \text{Loss/km (dB)} + 0.75 \text{ dB} + \\ &0.75 \text{ dB} + 0.3 \text{ dB} \end{aligned}$$

Two jumper reference method

The dual-ended reference removes the losses at Connection 1, Connection 2, and Connection 4 from the measurement.

Two jumper reference for single-mode fiber

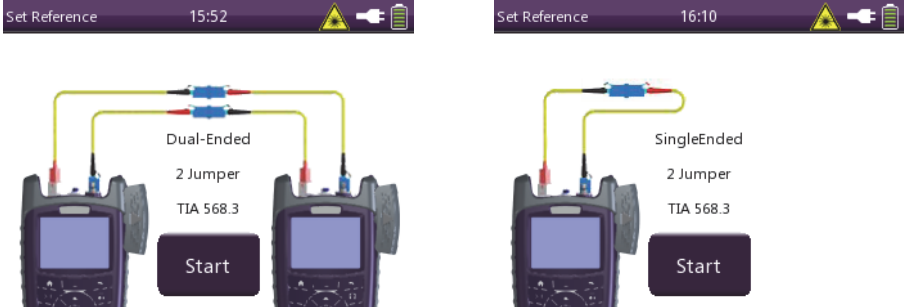

Fig. 13 Two jumper reference: single-mode remote and single-mode loopback

For more information on performing a measurement refer to [Fig. 18](#).

Reference connector to reference connector mated loss: 0.2 dB

Reference connector to random connector: TIA 568.3/
ISO 11801: 0.75 dB (ISO 14763-3 not allowed)

Random to random connector: 0.75 dB

Splice loss: 0.3 dB

Limit₁₄₇₆₃₋₃ = Two jumper method not considered in ISO 14763-3.

Limit_{TIA/11801} = Length of fiber * Loss/km + L_{conn2} (0 dB) + L_{conn3} + L_{conn4} +
L_{splice5} + L_{conn6} (0.75 dB)
= 0.75 dB + Length of fiber * Loss/km (dB) + 0.75 dB + 0.75 dB +
0.3 dB

Two jumper reference for multi-mode fiber

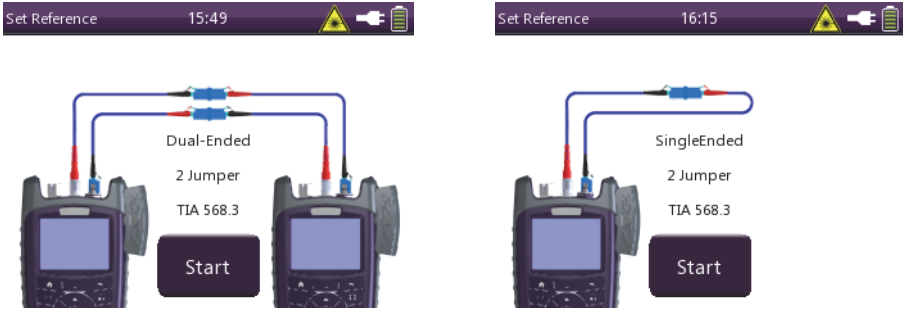

Fig. 14 Two jumper reference: multi-mode remote and multi-mode loopback

For more information on performing a measurement refer to [Fig. 18](#).

Reference connector to reference connector mated loss: 0.1 dB

Reference connector to random connector: TIA 568.3/
ISO 11801: 0.75 dB (ISO 14763-3 not allowed)

Random to random connector: 0.75 dB

Splice loss: 0.3 dB

Limit₁₄₇₆₃₋₃ = Two jumper method not considered in ISO 14763-3.

Limit_{TIA/11801} = Length of fiber * Loss/km + L_{conn2} (0 dB) + L_{conn3} + L_{conn4} +
L_{splice5} + L_{conn6} (0.75 dB)
= 0.75 dB + Length of fiber * Loss/km (dB) + 0.75 dB + 0.75 dB +
0.3 dB

Three jumper reference method

The dual-ended reference removes the losses at Connection 1, Connection 2, Connection 3, and Connection 4 from the measurement.

Three jumper reference for single-mode fiber

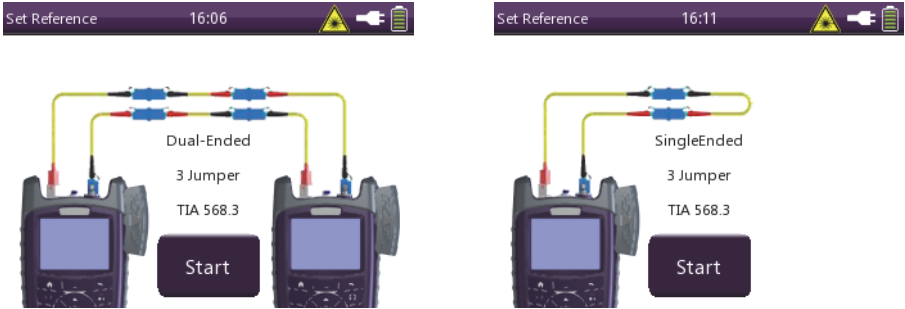

Fig. 15 Three jumper reference: single-mode remote and single-mode loopback

For more information on performing a measurement refer to [Fig. 18](#).

Reference connector to reference connector mated loss: 0.2 dB

Reference connector to random connector: ISO 14763-3: 0.5 dB,
TIA 568.3/ISO 11801: 0.75 dB

Random to random connector: 0.75 dB

Splice loss: 0.3 dB

$$\begin{aligned} \text{Limit}_{14763-3} &= \text{Length of fiber} * \text{Loss/km} + L_{\text{conn2}} (0.5 \text{ dB} - 0.2 \text{ dB}) + L_{\text{conn3}} + \\ &L_{\text{conn4}} + L_{\text{splice5}} + L_{\text{conn6}} (0.5 \text{ dB} - 0.2 \text{ dB}) \\ &= 0.6 \text{ dB} + \text{Length of fiber} * \text{Loss/km (dB)} + 0.75 \text{ dB} + 0.75 \text{ dB} + \\ &0.3 \text{ dB} \end{aligned}$$

$$\begin{aligned} \text{Limit}_{\text{TIA/11801}} &= \text{Length of fiber} * \text{Loss/km} + L_{\text{conn2}} (0 \text{ dB}) + L_{\text{conn3}} + L_{\text{conn4}} + \\ &L_{\text{splice5}} + L_{\text{conn6}} (0 \text{ dB}) \\ &= \text{Length of fiber} * \text{Loss/km (dB)} + 0.75 \text{ dB} + 0.75 \text{ dB} + 0.3 \text{ dB} \end{aligned}$$

Three jumper reference for multi-mode fiber

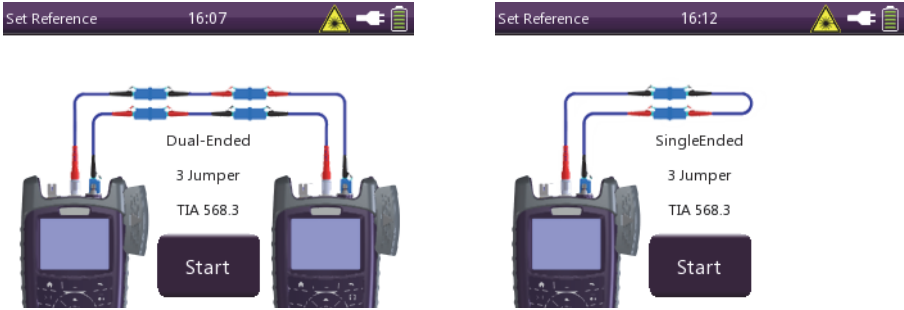

Fig. 16 Two jumper reference: multi-mode remote and multi-mode loopback

For more information on performing a measurement refer to Fig. 18.

- Reference connector to reference connector mated loss: 0.1 dB
- Reference connector to random connector: ISO 14763-3: 0.3 dB, TIA 568.3/ISO 11801: 0.75 dB
- Random to random connector: 0.75 dB
- Splice loss: 0.3 dB

$$\begin{aligned} \text{Limit}_{14763-3} &= \text{Length of fiber} * \text{Loss/km} + L_{\text{conn2}} (0.3 \text{ dB} - 0.1 \text{ dB}) + L_{\text{conn3}} + \\ &L_{\text{conn4}} + L_{\text{splice5}} + L_{\text{conn6}} (0.3 \text{ dB} - 0.1 \text{ dB}) \\ &= 0.4 \text{ dB} + \text{Length of fiber} * \text{Loss/km} (\text{dB}) + 0.75 \text{ dB} + 0.75 \text{ dB} + \\ &0.3 \text{ dB} \end{aligned}$$

$$\begin{aligned} \text{Limit}_{\text{TIA/11801}} &= \text{Length of fiber} * \text{Loss/km} + L_{\text{conn2}} (0 \text{ dB}) + L_{\text{conn3}} + L_{\text{conn4}} + \\ &L_{\text{splice5}} + L_{\text{conn6}} (0 \text{ dB}) \\ &= \text{Length of fiber} * \text{Loss/km} (\text{dB}) + 0.75 \text{ dB} + 0.75 \text{ dB} + 0.3 \text{ dB} \end{aligned}$$

Performing a measurement

Independent from the reference method your device under test (DUT) should be connected like this:



Fig. 17 Remote and loopback measurement

Example loss limit calculation

DUT

- 2 connectors
- 1 splice
- Multi-mode
- Fiber length: 842 m

Settings

- One jumper reference
- Loss per connection: 0.45 dB
- Loss per splice: 0.2 dB
- Cable loss: 3.5 dB/km

$$\begin{aligned} \text{Limit}_{14763-3} &= \text{Length of fiber} * \text{Loss/km} + L_{\text{conn}2} (0.3 \text{ dB}) + L_{\text{conn}3} + L_{\text{conn}4} + \\ &L_{\text{splice}5} + L_{\text{conn}6} (0.3 \text{ dB}) \\ &= 0.842 \text{ km} * 3.5 \text{ dB/km} + 0.3 \text{ dB} + 0.45 \text{ dB} + 0.45 \text{ dB} + 0.2 \text{ dB} + \\ &0.3 \text{ dB} = 4.65 \text{ dB} \end{aligned}$$

$$\begin{aligned} \text{Limit}_{TIA/11801} &= \text{Length of fiber} * \text{Loss/km} + L_{\text{conn}2} (0.75 \text{ dB}) + L_{\text{conn}3} + L_{\text{conn}4} + \\ &L_{\text{splice}5} + L_{\text{conn}6} (0.75 \text{ dB}) \\ &= 0.842 \text{ km} * 3.5 \text{ dB/km} + 0.75 \text{ dB} + 0.45 \text{ dB} + 0.45 \text{ dB} + 0.2 \text{ dB} + \\ &0.75 \text{ dB} = 5.55 \text{ dB} \end{aligned}$$

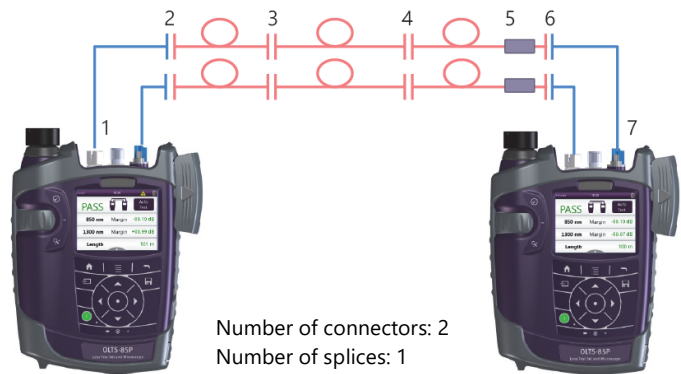

Fig. 18 Performing the single-mode or multi-mode measurement

For more information on performing different reference methods refer to “One jumper reference method” on page 38, “Two jumper reference method” on page 40, or “Three jumper reference method” on page 42.

Pass/Fail indication

Pass/Fail indication for losses is only available in Tier 1 mode. When performing fiber certification, the loss of the fiber system under test must be measured and compared to a calculated loss limit to provide a loss margin.

The calculated loss limit is the maximum allowable loss of the overall system and is based on the following factors:

- Length of the fiber
- Number of connections
- Number of splices

Each of the above factors has a loss associated with it. To assist your work, the standards and requirements for TIA 568.3, ISO 11801, and ISO 14763-3 are already specified in the instrument as preferences.

For loss limit calculation, associate the slope (loss per km) of your fiber under test to your fiber length. For loss per connection and splice, the technician must indicate how many connections and splices are present in the fiber system under test.

All connections to a reference cord are already considered by the OLTS-85. So, for the number of connections, please count all connections excluding the connections to a reference cord.

Pass indication

All measured losses are below or equal the calculated maximum loss **AND** the measured length is shorter or equal to the set length limit.

Fail indication:

One or more measured losses are above the calculated maximum loss **OR/AND** the measured length is longer than the set length limit.

6 POWERMETER OPERATION

General information



⚠ WARNING

Dangerous laser radiation

Laser radiation can cause irreparable damage to eyes and skin.

The maximum permitted power for the OLTS-85 means that the optical input signals can reach hazard level.

Bear this in mind when using the OLTS-85.

- ▶ Always be aware of the hazard level of the instrument to be connected.
 - ▶ Connect the optical fiber before switching on the radiation source.
 - ▶ Switch off the laser source before disconnecting the optical fibers.
 - ▶ Never look directly into the unconnected port of the output of a laser source or an optical fiber connected to it.
 - ▶ Always cover unused ports.
 - ▶ Heed the normal precautions for working with laser radiation and consider local regulations.
-

Powermeter measurement

Selecting a wavelength from the λ table

- ✓ The instrument is in **Powermeter** mode.
- ▶ Tap the lower left side of the touchscreen until the desired wavelength is displayed.
 - or –
- 1. Press the **[≡]** key.
- 2. Tap the **[λ]** button.
Select Wavelength menu is displayed.
- 3. To select a wavelength, tap a preselected wavelength.

Setting a wavelength in the λ table

To show or hide wavelengths in the λ table:

✓ The instrument is in **Powermeter** mode.

1. Press the [≡] key.
2. Tap the [More] button.
3. Tap the [Edit λ Table] button.

The λ table is displayed:

λ [nm]	Ref [dBm]	Limit [dBm]	Show
1310	+00.00	-06.50	
1490	+00.00	+00.00	✓
1550	+00.00	-06.70	
1625	+00.00	+00.00	✓

4. To edit the preselected wavelength and set/remove the checkmark, press the center key within the arrow keys.

– or –

Tap the desired wavelength value.

A wavelength is shown or hidden in the preselection.

To add a wavelength in the λ table:

✓ The **Edit λ Table** menu is displayed.

1. Press the [≡] key.
2. Tap the [Add λ] button.
3. Type in the desired value.
4. Tap the [OK] button.

► For other wavelengths, repeat steps 1 through 4 as required.

To delete a wavelength in the λ table:

✓ The **Edit λ Table** menu is displayed.

1. Select the desired wavelength.
2. Press the [≡] key.
3. Tap the [Delete λ] button.

To edit the limit for λ value:

- ✓ The **Edit λ Table** menu is displayed.
- 1. Select the desired wavelength.
- 2. Press the [☰] key.
- 3. Tap the [Edit Limit] button.
- 4. Type in the desired value.
- 5. Tap the [OK] button.

Enabling Auto λ mode

Auto λ is a special feature developed by Viavi that allows you to identify wavelengths automatically. To do this, the signal is modulated at a certain frequency (by a light source equipped with Auto λ), which can be detected by a Viavi OLTS-85.

In Auto λ mode, the detected wavelength is included in the λ table. As long as the detected wavelength is active, it cannot be deleted from the λ table.

Wavelengths cannot be reliably detected if:

- the receive level is too low,
- wavelength encoding cannot be detected due to interference,
- you are measuring the absolute level of a system that does not have wavelength encoding matching Viavi power sources.

To switch Auto λ mode on/off:

- ✓ The instrument is in **Powermeter** mode.
- 1. Press the [☰] key.
- 2. Tap the [More] button.

The menu opens:

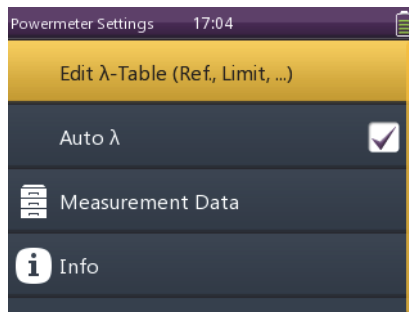

- 3. Tap the [Auto λ] button to set or remove the checkmark. The Auto λ mode is on/off.

Displaying modulated signals

The OLTS-85 automatically detects the modulation frequency of light signals modulated at the fixed frequencies of 270 Hz, 1 kHz, and 2 kHz. The detected frequency is shown in the lower right display pane of the **Powermeter** application.

Changing the power display mode

- ✓ The instrument is in **Powermeter** mode.
- 1. Press the [≡] key.
- 2. To toggle between the display modes, tap the [dBm/Watt] or [dB] button.
 - or –
 - To toggle between the display modes, tap the power level in **Powermeter** mode.

Displaying relative power level

The actual measured power level relative to a reference value is displayed in relative power display mode. The reference value can be set by defining the actual power level as the reference value or can be edited manually.

To set the reference level:

- ✓ The **Powermeter** screen is displayed.
- 1. Press the [≡] key.

The menu opens:



- 2. Tap the [Store ABS->REF] button to store the reference level.

The actual power level is set as the new reference level. The reference level is displayed underneath the wavelength. Reference power level display mode is activated.

Note: The reference level is stored for each wavelength and is saved even when the power is off.

To edit the reference level:

- √ The **Powermeter** screen is displayed.
 - 1. Press the [≡] key.
 - 2. Tap the [More] button.
 - 3. Tap the [Edit λ Table] button.
The λ table is displayed.
 - 4. Tap the desired wavelength value.
 - 5. Press the [≡] key.
 - 6. Tap the [Reference] button.
The Reference edit mode is displayed.
 - 7. Type in the desired value.
 - 8. Tap the [OK] button.
- For other wavelengths, repeat steps 4 through 7 as required.

7 LASER OPERATION



⚠ WARNING

Dangerous laser radiation

Laser radiation can cause irreparable damage to eyes and skin.

This device is a Class 1 laser product according to DIN EN 60825-1:2007.

- ▶ Always be aware of the hazard level of the instrument to be connected.
- ▶ Connect all optical fibers before switching on the radiation source.
- ▶ Switch off the laser source before disconnecting the optical fibers.
- ▶ Never look directly into the unconnected port of the instrument, the output of a laser source, or an optical fiber connected to it.
- ▶ Always cover unused ports.
- ▶ Heed the normal precautions for working with laser radiation and consider local regulations.

General information

Various fiber optic tests (e.g. loss test, fiber identification) require a reliable and stable optical source. OLTS-85 devices are high-quality optical sources, which in addition to a stable optical signal have other useful properties, which simplify and shorten the work processes and exclude potential sources of error in measurement setups.

OLTS-85 devices include several light sources – i.e. lasers and/or LEDs – which are stabilized using an automatic gain control mechanism. LEDs are typically used for multi-mode fiber measurements. On the other hand, lasers are used for single-mode fiber measurements.

Note: In this manual, the word laser is used synonymously for laser and LED sources.

The output signals of the light sources may be either continuous wave (CW) or modulated at certain frequencies, i.e. 270 Hz, 1 kHz, or 2 kHz. Viavi power meters (e.g. OLP-3x, OLP-8x) are capable of detecting these modulation frequencies. This method

improves ambient light rejection in certain measurement setups. Additionally, the modulated signals can be used for fiber identification or for confirmation of continuity.

OLTS-85 instruments provide the Auto λ feature. When activated, the OLTS-85 embeds wavelength ID information into the emitted signal(s). This wavelength ID information can be utilized by a compatible Viavi power meter (e.g. OLP-85) for automatic wavelength setup and for simultaneous reception of multiple wavelengths. This minimizes test time and prevents common errors such as incorrect wavelength setting on the optical power meter.

Furthermore, all OLTS-85 instruments provide Auto- λ -Multi and Auto- λ -Serial modes, which significantly reduce test time compared to manually switching wavelengths.

Display elements

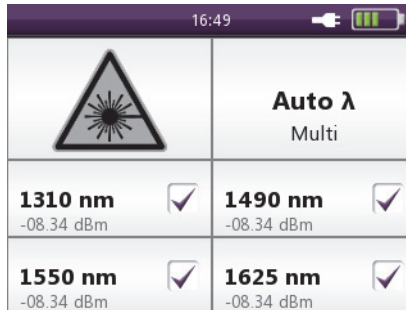

Fig. 19 Laser application

	<p>Laser On/Off Turn the laser on or off.</p>
<p>Auto λ Multi</p>	<p>Mode selection Switch between the modes CW, 270 Hz, 1 kHz, 2 kHz, and Auto λ.</p>
<p>1310 nm -08.34 dBm</p> <input checked="" type="checkbox"/>	<p>Wavelength selection Select the required wavelengths.</p>

Selecting a laser source

To select a wavelength from the laser source menu

- ✓ The instrument is in **Laser** mode.
- ▶ Tap one or multiple wavelengths in order to select them.
If the checkmark is shown, the dedicated wavelength is selected.
– or –
- 1. Press the [☰] key.
- 2. Tap the [Select Laser] button.
Select laser source menu is displayed.
- 3. Tap one or multiple lasers to select them.
If the checkmark is shown, the dedicated wavelength is selected.
- 4. Press the [↶] key.
- 5. To turn on the selected lasers, tap the [Laser on/off] field or press the center key within the arrow keys.

Note: If more than one laser is selected, only “Auto λ ” mode can be activated!

Auto λ feature

When in one of the Auto λ modes, the OLTS-85 embeds wavelength ID information into the emitted signal(s). This wavelength ID information can be utilized by a compatible Viavi power meter (e.g. OLP-85) for automatic wavelength setup and for simultaneous reception of multiple wavelengths.

Auto- λ -Multi mode is a proprietary Viavi solution that reduces testing time to a minimum by simultaneously testing at all wavelengths (see Fig. 20). Combined with a compatible power meter (e.g. OLP-85), the power meter automatically sets itself up for Multi λ test.

Auto- λ -Multi should be selected every time the optical powermeter supports the Auto- λ -Multi feature.

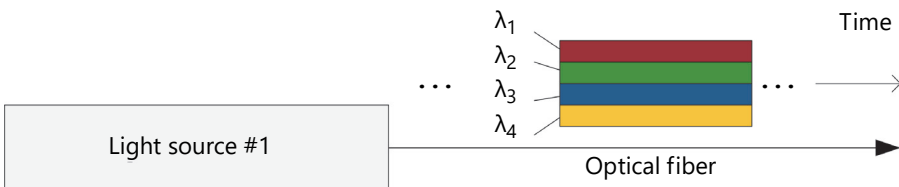

Fig. 20 Auto- λ -Multi

Auto- λ -Serial automatically toggles between all selected wavelengths (see Fig. 21), and, combined with a compatible power meter (e.g. OLP-3x, OLP-85), the power meter automatically sets up with correct wavelength settings. This mode should be selected when low levels are expected on the optical power meter or when the power meter doesn't support Auto- λ -Multi.



Fig. 21 Auto- λ -Serial

Note: Wavelengths cannot be reliably detected by a power meter, if

- the receive level is too low,
- the wavelength encoding cannot be detected due to interference, or
- you are measuring the absolute level of a system that does not have wavelength encoding matching Viavi power sources.

Selecting a mode

Tapping the [Mode selection] field (see Fig. 19) toggles between the modes as shown in the figure below. There are modes where only a single wavelength can be selected (i.e. CW, 270 Hz, 1 kHz, 2 kHz). Furthermore, there are Auto λ modes where multiple wavelengths can be selected (i.e. Auto λ , Auto- λ -Multi, Auto- λ -Serial). When only one (a single) wavelength is selected, the device is in Auto λ mode. When multiple wavelengths are selected, you can toggle between Auto- λ -Multi and Auto- λ -Serial mode.

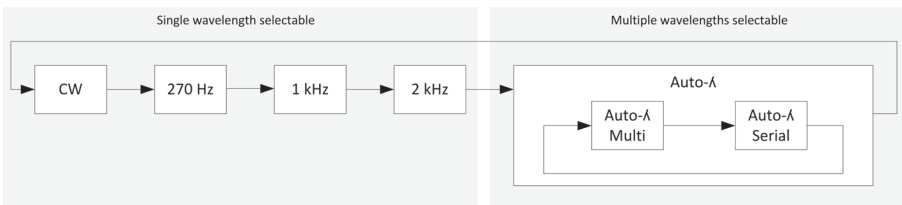
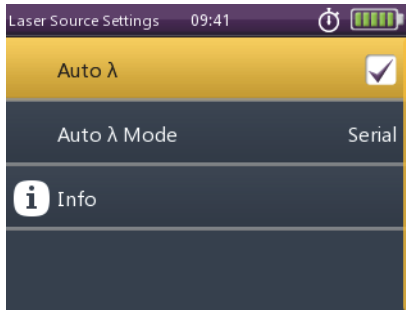

Fig. 22 Mode selection

Enabling Auto λ mode

To switch Auto λ mode on:

- ✓ The instrument is in **Laser** mode.
 - ▶ Tap the [Mode selection] field until Auto λ mode is shown.
 - or –
 - 1. Press the [☰] key.
 - 2. Tap the [More] button.
- The menu opens:*



- 3. Tap the [Auto λ] button to set or remove the checkmark.
The Auto λ mode is on/off.

Note: Signal modulation (270 Hz, 1 kHz, 2 kHz) cannot be selected when Auto λ is enabled.

To select the Auto- λ -Multi or Serial mode:

If multiple lasers are selected, you have the choice of Multi or Serial mode:

- Multi: All selected lasers emit simultaneously.
- Serial: The selected lasers emit successively.

- ▶ To toggle between Multi and Serial mode, tap the [Mode selection] field on the upper right side of the touchscreen.
 - or –
 - 1. Press the [≡] key.
 - 2. Tap the [More] button.
 - 3. Tap the [λ Mode] button.
 - 4. Tap the desired **Auto λ Mode**.

Enabling tone modulation

To enable tone modulation:

- ▶ Tap the [Mode selection] field on the upper right side of the touchscreen until the desired modulation frequency is displayed.
 - or –
 - 1. Press the [≡] key.
 - 2. Tap the [Modulation] button.
 - 3. Tap the desired laser modulation.
 - CW – Continuous Wave, 270 Hz, 1 kHz, or 2 kHz is marked.*

Note: A modulation frequency of 270 Hz, 1 kHz, or 2 kHz can be set only if one single laser is selected and Auto λ is turned off.

Setting the power level

The power level can be set for each wavelength separately and will be stored permanently.

Changing the power level

- √ The instrument is in **Laser** mode.
 - 1. Press the [≡] key.
 - 2. Tap the [Adjust Level] button.
 - 3. Tap the desired wavelength.
 - The display changes to edit mode.*
 - 4. Press the arrow keys to increase or decrease the power level. Press once to change the level in 0.01 dBm steps.
 - or –
 - Hold down the key to accelerate the step rate.
 - 5. Press the [↩] key.

Switching on/off the laser



⚠ WARNING

Dangerous laser radiation

Laser radiation can cause irreparable damage to eyes and skin.

This device is a Class 1 laser product according to DIN EN 60825-1:2007.

- ▶ Always be aware of the hazard level of the instrument to be connected.
 - ▶ Connect all optical fibers before switching on the radiation source.
 - ▶ Switch off the laser source before disconnecting the optical fibers.
 - ▶ Never look directly into the unconnected port of the instrument, the output of a laser source, or an optical fiber connected to it.
 - ▶ Always cover unused ports.
 - ▶ Heed the normal precautions for working with laser radiation and consider local regulations.
-

- √ The instrument is in **Laser** mode.
- ▶ To switch on the laser, tap the [Laser on/off] field.
 - or –
- ▶ Press the center key within the arrow keys.
 - or –
- 1. Press the [≡] key.
- 2. Tap the [Laser on] button.
- ▶ To switch off the laser, repeat one of the actions mentioned above.

8 PROBE/PCM OPERATION

General information

Dirty and/or damaged connectors are often the root cause of optical network problems. The Probe and PCM applications enable industry standard inspection and automated Pass/Fail testing with report generation of optical connectors/adapters in order to ensure industry standard fiber endface quality and cleanliness.

For best workflow efficiency, there are two variants of fiber microscopes available in the SmartClass™ Fiber family. The integrated Patch Cord Microscope (PCM), which is best suited for inspecting fiber endfaces of patch cords, and the external P5000i Digital Probe (see “Accessories” on page 81), which may be used either for bulkhead inspection or patch cord inspection. The shortest inspection time is achieved when using one of the OLP-87P/OLP-85P models with an integrated PCM for patch cord inspection and a P5000i Digital Probe for bulkhead inspection.

Both applications – Probe and PCM – behave essentially the same and are described together below.

Note: Only if a P5000i Digital Probe is connected to the instrument is the Probe application fully functional. Select an OLP-87P/OLP-85P version in order to get PCM functionality.

Patch Cord Microscope (PCM)

The PCM is a microscope used to view and inspect patch cord (male) sides of fiber connectors.

In order to support a wide variety of fiber optic connectors, the PCM provides an exchangeable FMAE adapter. The dedicated QuickCapture key enables either instant triggering of a Pass/Fail test or freezing of the live image. For best workflow adaption, the key action is configurable. The dedicated Magnification Control key provides fast toggling between two microscope magnification levels, low magnification for high level inspection of the fiber endface, and high magnification for detailed inspection of the fiber endface.



Fig. 23 Patch cord microscope components

- | | |
|---|---------------------------|
| 1 | FMAE adapter |
| 2 | QuickCapture™ key |
| 3 | Focus Control |
| 4 | Magnification Control key |

FMAE series adapters for the PCM

SmartClass™ Fiber devices with the PCM use FMAE series adapters to ensure consistent and accurate inspection for a wide variety of connectors and applications. All PCM configurations ship with a 2.5 mm interface included. Kitted configurations may include additional FMAE adapters.

Features available with the P5000i Digital Probe

The P5000i Digital Probe is a portable handheld microscope used to view and inspect both the bulkhead (female) and patch cord (male) sides of fiber connectors, as well as other optical devices, such as transceivers.

The Digital Probe is specially designed to fit and operate comfortably and easily in-hand, allowing the user to inspect hard-to-reach connectors that are installed on the back side of patch panels or inside hardware devices. In order to support a wide variety of fiber optic connectors, the P5000i provides an exchangeable FBPT inspection tip. The dedicated QuickCapture key enables either instant triggering of a Pass/Fail test or freezing of the live image. For best workflow adaption, the key action is configurable. The dedicated Magnification Control key

provides fast toggling between two microscope magnification levels - low magnification for high level inspection of the fiber endface and high magnification for detailed inspection of the fiber endface.

The P5000i Digital Probe kit sold with the OLTS-85 contains the standard barrel assembly (FBPP-BAP1), standard patch cord tips, and standard bulkhead tips. See "Accessories" on page 81.

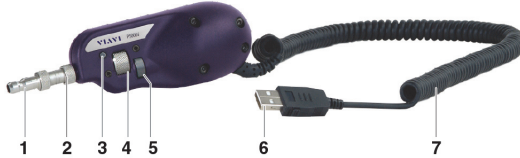

Fig. 24 P5000i Digital Probe components

1	Inspection tip
2	Barrel assembly
3	QuickCapture™ key
4	Focus Control
5	Magnification Control key
6	USB 2.0 connector
7	1.83 m (6 ft) coil cable

FBPT series tips for the P5000i

The P5000i Digital Probe uses FBPT series inspection tips to ensure consistent and accurate inspection for a wide variety of connectors and applications. These connector-specific and universal inspection tips are interchangeable, which allows the P5000i Digital Probe to interface with different types of fiber connectors.

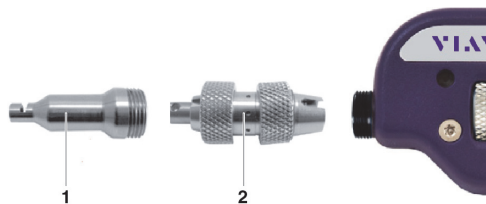

Fig. 25 FBPT series tips for the P5000i

1	Inspection tip
2	Barrel assembly

P5000i connection

The Probe application requires a P5000i Digital Probe in order to be fully functional (see the list of all accessories in “Accessories” on page 81).

1. Plug your P5000i into a USB port.
2. Connect the P5000i to the fiber being inspected.
3. Press the **[↵]** key, then tap the **[Probe]** button or use the arrows keys.
– or –

Press the **[≡]** key to toggle between the measurement view and the inspection view.

The P5000i will display the live view.

QuickCapture™ key

In order to support different workflows, the functionality of the QuickCapture™ key is configurable. Pressing the key will either freeze the live image or start a test:

Test	Pressing the key will automatically freeze the live image and perform a test.
Freeze	Pressing the key will automatically freeze the live image.

Camera mode

Set the QuickCapture™ key on the Digital Probe to get a live picture of the result.

Tip: Use the Focus Control key to adjust the focus of the image.

- ✓ The Digital Probe is connected to the instrument.
- ▶ To display the live view, tap the **[Probe]** button.

File toolbar

Saving a picture

It is possible to save the frozen picture from the Digital Probe.

1. Press the **[≡]** key.
2. Edit the file name.
3. Tap the **[OK]** button.

File is saved in the preselected group.

Configuring the Digital Probe

1. Tap the [Probe] button.
2. Press the [≡] key to configure the Digital Probe according to the following description.

Brightness settings

1. Set the luminosity manually using the arrow keys.
 - or –
 - Tap the key [≡] > [Brightness] to tune the luminosity to the desired value.
2. Tap the [OK] button.
 - or –
 - To confirm, press the center key within the arrow keys.

Test mode

Launching a test of the connector and fiber end-face

See “Freeze mode” on page 64 for more information on commands available.

To launch the test with the predefined profile (see “Profile” on page 65):

1. With the P5000i Digital Probe, use the Focus Control key (see Fig. 24) to adjust the image quality and sharpness.
2. Press the [≡] key and tap the [Test] button.

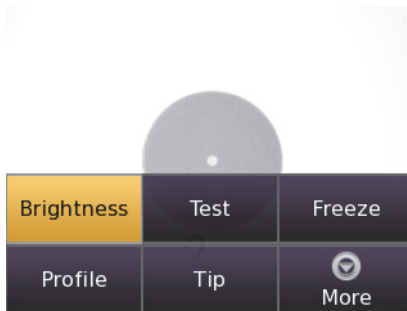

– or –

Press the QuickCapture™ key on the Digital Probe if the button action is set to **Test**.

When the test procedure terminates, the information shown on the display depends on the current overlay setting:

- Press the [≡] key and then the [Overlay] button to change the overlay view. Repeat the action until the desired view appears. *Three views can be displayed: without overlay, with colored edges, and colored edges with a legend.*

Overlay

A summary of test results is displayed at the upper right of the screen.

Zone A: represents the core zone. It is the area surrounding the core.

Zone B: represents the cladding zone. It surrounds the majority of the fiber cladding.

Zone C: represents the epoxy ring.

Zone D: represents the ferrule zone. It identifies a portion of the ferrule near and around the fiber.

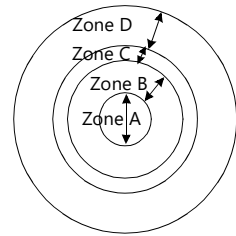

Note: To return to a Live image, press the QuickCapture™ key or press the [≡] key and tap the [Live] button to view both the live image and a test result simultaneously. If the test has been passed, the image has a green colored frame. If failed, the frame is red.

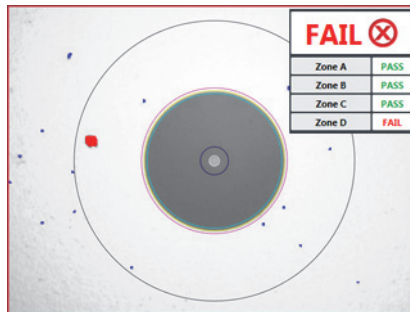

Fig. 26 Pass/Fail analysis – overlay view

Magnification Control

The Magnification Control allows you to modify the live display from high to low magnification and vice-versa. In the high magnification mode, automatic centering is available.

Picture selected: Live

- Test Allows you to launch a (new) test of the connector (see [“Launching a test of the connector and fiber end-face” on page 62](#))
- Freeze Allows you to freeze the live image and to save it later on the disk. Once this key is pressed, the freeze image is automatically set to position 2.

Picture selected: Test

Save allows you to save the selected picture in the currently selected group in the disk of the instrument. Press the **[F]** key, enter a name for the JPG file, and validate.

Overlay allows you to display or hide the limits of each zone and the defaults on an image from a test result.

Magnification Control allows you to switch all the images from Digital Probe test results from high to low magnification and vice-versa.

Saving the test result in a JPG file

Once the test has been performed and the result is displayed on the OLTS-85 screen:

1. Press the **[F]** key to save a JPG file of the test result in the currently active group on the OLTS-85.
2. On the edition keypad, enter the name of the JPG file.
3. Press Enter to validate and save the document.

The file is saved in the current active group directory on the OLTS-85.

Freeze mode

Once the image is acceptable (sharpness, luminosity are tuned correctly), you may freeze the picture. This feature allows you to store the resulting picture in order to compare it later to others or save it in a file. In Freeze mode, the picture has a blue colored frame.

Tip: Freezing a result does not store the picture in a file (see [“Saving a picture” on page 61](#)). The result will be lost if the instrument is shut off.

Depending on the QuickCapture™ key setting, this key allows you to freeze the picture or to start a test.

Profile

1. Press the [≡] key.
2. Tap the [Profile] button.
3. Tap the Profile which will be used for the test of the fiber connector:
 - E2000: Pass/Fail criteria for precision metal ferrule connectors.
 - Ribbon_: Pass/Fail criteria for single-mode and multi-mode connectors from IEC 61300-3-35 standard.
 - SM-UPC: Pass/Fail criteria for single-mode UPC connectors from IEC 61300-3-35 standard.
 - SM-APC: Pass/Fail criteria for single-mode APC connectors from IEC 61300-3-35 standard.
 - SM_PC: Pass/Fail criteria for single-mode PC connectors from IEC 61300-3-35 standard.
 - MM_: Pass/Fail criteria for multi-mode connectors from IEC 61300-3-35 standard.
 - SFP_: Pass/Fail criteria for small form-factor pluggables.

Profiles contain the analysis parameters from which Pass/Fail criteria are determined.

Tip

1. Press the [≡] key.
2. Tap the [Tip] button.
3. Select the tip set on the Digital Probe to connect fiber for inspection and tap on the tip set.

More

1. Press the [≡] key.
2. Tap the [More] button to view or change the storage location, settings and information of the Digital Probe.

9 MEMORY MANAGEMENT

General information

The OLTS-85 allows you to save measured values and inspection images in a structured data memory and recall them as required. Data can also be downloaded via the USB interface to a PC for further evaluation.

In general there are two different modes available for data saving:

Link Data Mode

In case of applying different measurements e.g. Tier 1, PCM inspection and probe inspection on one DUT, the saved results of all application are assigned to a dedicated project and FiberID. So, all measurements on one fiber performed with different applications can be easily assigned by the reporting software FiberChekPRO. The parameters for saving or reading data can be set only globally from the homescreen menu for all applications simultaneously.

Non Linked Mode

The result of a measurement application is saved under a free selectable file name (default file name is the determined incremental prefix) without any assignment to other measurements. Projects for saving and reading data can be set individually for each application.

To open the data menu:

- ✓ The homescreen is displayed.
- 1. Press the [☰] key.
- 2. Tap the [Data] button.

To view measurement data:

- ✓ The data menu is displayed.
- 1. Tap the [View Data] button.
- 2. Select an application to view all its saved data referring to the selected project.

To change the data settings:

Before you start your measurements you should determine a project and a prefix for your DUT.

- ✓ The homescreen is displayed.

1. Press the [≡] key.
2. Tap the [Data] button.
3. Tap the [Data Settings] button.

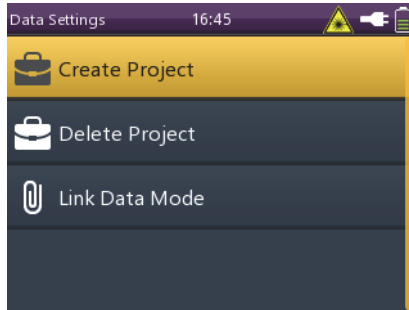

Fig. 27 Data Settings menu

To create a project:

✓ The homescreen is displayed.

1. Press the [≡] key.
2. Tap the [Data] button.
3. Tap the [Data Settings] button.
4. Tap the [Create Project] button to determine a new project.
The project appears in all available applications.

To delete a project:

✓ The homescreen is displayed.

1. Press the [≡] key.
2. Tap the [Data] button.
3. Tap the [Data Settings] button.
4. Tap the [Delete Project] button to delete a project with all assigned data.
The default project is always present and can't be deleted.

To use the Link Data Mode:

1. Select one of your predefined projects.
2. Determine a prefix for your DUT. In case of saving data, this prefix, attached with an incremental index, is used as a file name.

To change the auto incremental index:

- ▶ Select [AutoInc Index Mode] to change the current used index attached to the prefix.

To select Link Data:

- ▶ Tap the [Link Data Mode] button to select or deselect the link data mode.
The data link mode is indicated with a paperclip symbol in the status bar

To select view linked data:

- ✓ This menu item is only visible, if **Link Data Mode** is selected.
- ▶ Displays the number of saved data for each individual application dedicated to an incremental prefix

To export CSV to an USB Stick:

- ▶ Tap the [Export CSV to USB Stick] button to export all saved data to USB drive in CSV format.
This file can be imported in an Excel sheet.

Selecting the project to save or display results

All saved results are assigned to a project. If the user didn't define a project, the default project, which is always present, is used.

In **Link Data Mode** the active project can be selected only from the homepage menu for all applications simultaneously.

The results and images are stored in the project most recently selected.

To select another project:

- ✓ An application is started.
- ✓ The instrument is in the **Data** view.
- ✓ **Link Data Mode** is not activated.
- 1. Press the [☰] key.
- 2. Tap the [Project] button.
- 3. Select a project.
Selected project is displayed.

Tip: The **Data** can be distinguished by the **Timestamp**.

Saving results

Note: For Tier 1 Test application: Loss- and length measurement results can be saved **only** on the instrument which is configured as **Local**. On the **Remote** instrument only inspection results can be saved.

Results are stored simply by pressing the [F] key. Each time the key is pressed, the results will be stored.

Note: If an instrument with integrated patch cord microscope is connected to a Digital Probe, the images for the PCM and the Digital Probe will be stored in different folders.

To save current results successively:

- ✓ The instrument is in application mode.
- ✓ **Link Data Mode** is not activated.
- 1. Press the [≡] key.
- 2. Tap the [More] button.
- 3. Tap the [Measurement Data] button.
- 4. Press the [≡] key.
- 5. Tap the [More] button.
- 6. Tap the [AutoInc FiberID] button to set the checkmark.
- 7. Press the [F] key.

The Fiber ID edit menu is displayed:



- 8. Type in the **Fiber ID**.
- 9. Tap the [OK] button.
- 10. Press the [F] key again every time you want to save an additional result value.

The display briefly shows the Fiber ID used.

Note: If the **Fiber ID** is not changed, the data set will be saved under the same title. Depending on the active application, the **Data** can be distinguished by the **Timestamp**.

Displaying stored results

To display the last results stored:

- ✓ The homescreen is displayed.
 1. Press the [☰] key.
 2. Tap the [Data] button.
A selection of the available applications is displayed.
 3. Tap the desired application button.
 – or –
- ✓ The instrument is in application mode.
 1. Press the [☰] key.
 2. Tap the [More] button.
 3. Tap the [Measurement Data] button.
The measurement data of the currently selected project is displayed:

✓	Fiber ID	λ [nm]	Pow [dBm]
✓	BAKER.STREET.10	1310	LOV
✓	BAKER.STREET.10	1490	LOV
✓	BAKER.STREET.10	1550	LOV
	FIBERID12	1310	LOW

To display the last results stored in Probe mode:

- ✓ The homescreen is displayed.
 1. Tap the [Data] button.
 2. Tap the [Probe] button.
Measurement data of the currently selected project is displayed.
 3. Select the measurements you would like to view with the up or down arrow key and press the center key within the arrow keys to set a checkmark.
 – or –
 To set a checkmark, tap the desired measurements.
 4. Press the [☰] key and tap the [View Selected] button to view the selected measurements.
 5. Navigate through the selected measurements with the left or right arrow key.
 6. Press the [↶] key if you wish to go back to the previous screen.

Using the Link Data Mode

In case of applying different measurements e.g. Tier 1, PCM inspection and probe inspection on one DUT, the saved results of all application are assigned to a dedicated project and FiberID. So, all measurements on one fiber performed with different applications can be easily assigned by the reporting software FiberChekPRO. The parameters for saving or reading data can be set only globally from the homescreen menu for all applications simultaneously.

To create a project:

- ✓ The homescreen is displayed.
 - 1. Press the [☰] key.
 - 2. Tap the [Data] button.
 - 3. Tap the [Data Settings] button.
 - 4. Tap the [Create Project] button.
 - 5. Type in a **Project Name**, e.g. "CO_MillerSt.16".
 - 6. Tap the [OK] button.
- The project is created.*

To activate the Link Data Mode:

- ✓ The homescreen is displayed.
 - ✓ The desired project is selected.
 - 1. Press the [☰] key.
 - 2. Tap the [Data] button.
 - 3. Tap the [Link Data Mode] button.
- A paperclip symbol appear in the status bar.*
- 4. Press the [↶] key to exit the menu.

To set your Link Data Mode parameters:

- ✓ The **Data** menu is displayed.
- 1. Set your Prefix, e.g. "CablePair".
- 2. Set your Index to the initial value, e.g. "1".

To start the application and save the measurements:

- ✓ The homescreen is displayed.
- ✓ Tap on the desired application, e.g. Tier 1 Test.
- 1. Perform a measurement.
- 2. Press [⌘] key.



Fig. 28 View linked data

The number of measurements saved for each application will be displayed.

Tapping the [H] button, saves your recently measured data under the corresponding application. If all measurements done for your DUT, please tap the [Inc] button to increment the index.

Clearing the memory

Each data set contains the wavelength, the relative power level and reference value or the absolute power level, the threshold set, and the date/time when it was stored.

You do not have to clear the entire memory to free up capacity. You can clear individual data or projects.

The OLTS-85 has the following memory clear functions:

- **Delete Selected**
Clears the data of the selected measurement
- **Delete Project**
Clears all the measurements of the selected project

To clear the memory data:

- ✓ The instrument is in application mode.
- 1. Press the [☰] key.
- 2. Tap the [More] button.
- 3. Tap the [Measurement Data] button.
- 4. Select the measurement entries you want to delete.
- 5. Tap the [Delete Selected] button.
- 6. Press the [↩] key to exit from the menu.

Note: Now if you save results, they will be stored at the memory location of the last group displayed.

To clear all the data of a project:

- √ The homescreen is displayed.
- 1. Press the [≡] key.
- 2. Tap the [Data] button.
- 3. Tap the [Delete Project] button.
- 4. Select the project you want to delete.
- 5. Press the center key within the arrow keys or press the [↩] key to cancel the delete process.

10 MAKING A REPORT

In order to make a report, please download the FiberChekPRO reporting software from the Viavi web site <http://updatemyunit.net>.

- ▶ Connect your instrument to your PC via the USB port and follow the instructions on the screen.

To import inspection data for the Tier 1 Test application:

Note: For Tier 1 Test application: Before you make a report for your Tier 1 tests, you need to move your inspection results saved on the **Remote** instrument to the **Local** instrument.

- ▶ Connect your **Local** instrument using the Micro-USB connector of the **Remote** instrument.
- ✓ The homescreen on the **Local** instrument is displayed.
 1. Press the [≡] key.
 2. Tap the [Data] button.
 3. Tap the [Import Inspection Data] button and start the data transfer from **Remote** to **Local**.

11 MAINTENANCE



⚠ WARNING

Dangerous voltage and invisible laser radiation

Maintenance or cleaning of the instrument while it is connected or operating may damage the instrument or injure you.

- ▶ Make sure that the instrument is switched off and disconnected from all power sources and optical radiation sources before maintenance or cleaning.

Cleaning the test port

It is a good idea to check that the optical connections are clean and clean them if necessary before starting measurements. Even very small dust particles on the end surfaces of the plugs or in the test adapters can adversely affect the accuracy of the measurement.

1. Switch off the instrument.
2. Remove the test adapter from the optical connection.
The plug end surface is now accessible.
3. Wipe off the plug end surface using a cotton bud soaked in isopropanol.
This cleaning method is very effective and leaves no residue.
4. Blow out the test adapter with clean compressed air (available in spray cans, e.g. anti-dust spray).

Note: Cover the optical connections with the dust cap whenever they are not in use. This prevents them from getting dirty.

Cleaning the instrument

If the instrument gets dirty through use, you can clean it using a soft cloth moistened with a mild solution of detergent.

NOTICE

Water and cleaning fluids

The instrument may be damaged or destroyed if water or cleaning fluids penetrate it.

- ▶ Make sure that water or cleaning fluids do not penetrate the instrument.
-

12 SPECIFICATIONS

General specifications

Fiber inspection	Via P5000i Digital Probe with auto Pass/Fail analysis
Live image	320 x 240 pixels, 8 bit gray, 10 fps
Display	High contrast 3.5" TFT color touchscreen
Display resolution	0.01 dB / 0.001 μ W
Measurement units	dB, dBm, W
Data memory	10000 measurement results
Data readout	Via client USB interface or Ethernet
Remote control capability	Via USB
Electrical interfaces	2 USB Type A, 1 USB Micro-B, Ethernet
Power supply	Four-way power: NiMH, dry batteries, RBP2 Li-Ion Battery Pack, PS4 Universal AC/DC Power Supply 12 V Internal charging for RBP2 Li-Ion Battery Pack
Optical connectors	2.5 mm UPP (1.25 mm UPP optional)
Recommended recalibration interval	3 years
Size (H x W x D) OLTS-85	208 x 112 x 64 mm (8.2 x 4.4 x 2.5 in)
Size (H x W x D) OLTS-85P	208 x 153 x 64 mm (8.2 x 6.0 x 2.5 in)
Weight OLTS-85/OLTS-85P	750 g/850 g
Operating temperature range	-5 °C to +45 °C (23 °F to 113 °F)
Storage temperature range	-25 °C to +55 °C (13 °F to 131 °F)

Power meter specifications

Optical interface	Interchangeable adapter LC/PC, LC/APC (optional: SC, ST, FC, DIN, E2000 and UPP 2.5 mm and UPP 1.25 mm)
Adjustable wavelength range	800 nm to 1700 nm in 1 nm steps
Calibrated wavelengths	850 nm, 980 nm, 1300 nm, 1310 nm, 1490 nm, 1550 nm, 1625 nm
Photo diode	InGaAs
Fiber types	9/125 to 62.5/125
Power measurement range	-75 dBm to +15 dBm
Resolution	0.01 dB, 0.001 μ W
Maximum permitted input level	+15 dBm
Absolute measurement uncertainty ¹⁾	\pm 0.13 dB (\pm 3 %)
Linearity	0.1 dB
Automatic offset nulling	Yes
Measurement units	dB, dBm, Watt
Display resolution	0.01 dB/0.0001 μ W
Power meter functions	Absolute, relative, pass/fail, Auto λ
Warm-up time	None, instant-on
Wavelength detection ²⁾	Automatic switching and displaying up to 4 wavelengths simultaneously
Modulation detection ²⁾	270 Hz, 1 kHz, 2 kHz
Overall measurement uncertainty for calibrated wavelengths	\pm 0.5 dB, \pm 3 pW (-75 dBm to +15 dBm at -5 °C to +45 °C)

1) Under reference conditions: -20 dBm (CW), at 1310 nm \pm 1 nm, 23 °C \pm 3K, 9 μ m test fiber with SC/PC ceramic connector

2) With Viavi Optical Light Source
800 nm to 1650 nm: for levels > -50 dBm

Light Source specifications

	Multi-mode	Single-mode
Optical interface	Interchangeable adapter FC/PC (optional: SC, ST and LC adapters)	Interchangeable adapter SC/PC (optional: FC, ST and LC adapters)
Source type and wavelengths	LED source 850 nm ¹⁾ 1300 nm ¹⁾	Fabry-Perot laser diode 1310 nm ¹⁾ 1550 nm ¹⁾
Spectral width	50/170 nm	5/5 nm
Launch condition	Encircled Flux compliant to TIA-526-14 and IEC 61280-4-1 ²⁾	
Output power settable in 0.1 dB steps	-20 to -23 dBm	0 to -3 dBm
Stability ³⁾ 15 min	\pm 0.02 dB	\pm 0.02 dB
Stability ³⁾ 8 h	\pm 0.2 dB	\pm 0.2 dB
Source modes	CW, Tone, Auto- λ , Multi- λ	

Tone generator	270 Hz, 1 kHz, 2 kHz
Laser safety	IEC 60825-1:2007
Laser classification	CLASS 1 LASER PRODUCT

- 1) Typically ± 20 nm
- 2) At the output of the EF-TRC. Variations between EF measurement equipment may occur but EF compliance can be expected with a 95 % confidence factor. Valid for IEC 61280-4-1 at 850 nm.
- 3) At constant temperature, after a 20 minute warm-up.

Tier 1 specifications

	Multi-mode	Single-mode
Testing speed ¹⁾ Remote mode		< 6 s
Loopback mode		≤ 3 s
Pass/fail limit standards	TIA 568.3, ISO 11801 and ISO/IEC 14763-3, link validation	
Fiber type	50/125 μ m	9/125 μ m
Nominal test wavelengths	850/1300 nm	1310/1550 nm
Maximum length measurement	12 km	100 km
Length measurement accuracy ²⁾	± 1.5 m plus ± 1 % of length	
Loss measurement uncertainty ³⁾	< 0.2 dB	

- 1) Two wavelengths, one direction (excludes referencing and connection times).
- 2) For multi-mode up to 3 km range, for single-mode up to 10 km range. Link loss consists only of fiber loss, connector loss and splice loss.
- 3) After 20 min warm up, at constant temperature, no charging. For multi-mode loss measurements with 50/125 μ m fibers (NA=0.20). For single-mode loss measurements with 9/125 μ m fibers (NA=0.10).

Patch cord microscope specifications

Optical interface	FMAE LC duplex (many other adapters available)	
Auto pass/fail analysis standards	IEC 61300-3-35 and custom limits	
Live image	320 x 240 x 8 bit grey, 10 fps	
Light source	Blue LED, 100.000+ hours life	
Lighting technique	Coaxial	
Magnification	Horizontal	740/370 μ m
field-of-view		
low/high	Vertical	550/275 μ m
External USB connected P5000i Digital Probe supported.		

13 ORDERING INFORMATION

OLTS-85 Optical Loss Test Set

OLTS-85 Tier-1 SM Optical Loss Kit	BN 2325/31
OLTS-85 Tier-1 MM Optical Loss Kit	BN 2325/34
OLTS-85 Tier-1 Quad Optical Loss Kit	BN 2325/35
OLTS-85P Tier-1 Quad Optical Loss Kit with Patch Cord Microscope and FMAE adapter	BN 2326/35

Included items

- SmartClass™ Fiber instrument
- Universal AC/DC Power Supply with Li-Ion Battery Pack
- Soft shoulder case for SmartClass™ Fiber
- Adapter 29: LC, F-3000 (-PC, -APC)
- Mating sleeves for LC/LC plugs
- USB cable
- Quick Start Manual and Safety Instructions
- The latest Operating Manual, and FiberChekPRO reporting software can be downloaded at the Viavi web site <http://updatemyunit.net>.

Additional items in SM Kit

- SM test reference cord SC-LC, and LC-LC

Additional items in MM Kit

- MM test reference cord FC-LC, and LC-LC

Additional items in Quad Kit

- SM test reference cord SC-LC, and LC-LC
- MM test reference cord FC-LC, and LC-LC

Additional items in Quad Kit with PCM

- FMAE duplex LC adapter
- SM test reference cord SC-LC, and LC-LC
- MM test reference cord FC-LC, and LC-LC

Accessories

P5000i Digital Probe Microscope with FiberChekPRO software	FBP-P5000i
Calibration report	BN 2325/90.01
UC4 hands free carrier for SmartClass™ Fiber	BN 2128/01
UC4P hands free carrier for SmartClass™ Fiber with PCM	BN 2128/02

INDEX

A

- AC line plug adapter 20
- Auto Lambda mode 48, 55
- Auto-Off 24

B

- Batteries
 - Danger 17
 - Recharging 18
 - Replacing 17
 - Tips 18
- Battery operation 11

C

- Cables, connecting 21
- Cleaning
 - Instrument 75
 - Optical connections 75
 - Test port 75
- Clearing the memory 72
- Common features 7
- Condensation 14
- Connecting optical cables 21
- Connector panel 16
- Control panel 23

D

- Damage during shipping 14
- Default values 29
- Device overview 15
- Differences between the devices 7
- Display elements 24
- Displaying
 - Modulated signals 49
 - Relative power level 49

E

- Environmental Management Program 85
- Environmental protection 19

F

- Factory default 29
- Firmware update 30

L

- Laser safety 11
- Link Data Mode 24, 52, 71
- Loss length and polarity
 - Tier 1 32
- Loss Test 32
- Loss Test Set 5

M

- Menu
 - Configuration 26
 - Menu navigation 25
- Modulated signal, displaying 49

N

- Navigating in the menus 25

O

- On/Off 23
- Operation
 - Probe/PCM 58
- Operation from AC power 20
- Overview 15

P

- Package contents 14
- Packing material 14
- Pass/Fail 45
- Power level
 - Relative 49
- Power mode 23
- Power supply 17
- Powermeter
 - Measurement 32, 46
- Project
 - Create 71

- Link measurement data 71
 - Select 71
- Proper usage 10
- PS4 Universal AC/DC Power Supply 12

R

- Recovery 14
- Recycling 19, 86
- Reference Method
 - One jumper 38
 - Three jumper 42
- Report 74
 - Tier 1 Test 74
- RoHS 87

S

- Saving results 68
- Shipping damage 14
- Specifications
 - General 77

T

- Test adapter, mounting 21
- Tier 1
 - Changing settings 32
 - One jumper reference method 38
 - Optical loss test 32
 - Performing a loss test 36
 - Referencing methods 37
 - Three jumper reference method 42

U

- Update
 - Firmware 30

Viavi Environmental Management Program

Superb performance and high quality have always characterized Viavi datacom and telecom measurement technology products. In this same world-class tradition, Viavi has an established, proactive program of environmental management.

Environmental management is an integral part of Viavi's business philosophy and strategy requiring the development of long-term, productive solutions to problems in the key areas of economics, technology, and ecology.

A systematic environmental management program at Viavi is essential in regard to environmental policy and enhances cooperation between ourselves and our business partners.

The Viavi Environmental Management Program considers:

Product design and manufacture

Environmental restrictions and requirements are taken into account during planning and manufacture of Viavi products. This attention ranges from the raw materials and finished components selected for use and the manufacturing processes employed, through to the use of energy in the factory, and right on up to the final stages in the life of a product, including dismantling.

Hazardous materials

Viavi avoids or uses with care any hazardous or dangerous material in the manufacturing process or the end product. If the use of a dangerous material cannot be avoided, it is identified in product documentation and clearly labeled on the product itself.

Packaging materials

Preference is given to reusable or biodegradable single-substance packaging materials whenever possible.

Environmental management partnerships

Viavi encourages our customers and suppliers who take this responsibility seriously to join Viavi in establishing their own environmental management programs.

Recycling used products

This product complies with the European Union Waste Electrical and Electronic Equipment directive (WEEE), 2002/96/EC. This product should not be disposed of as unsorted municipal waste and should be collected separately and disposed of according to your national regulations.

In the European Union, all equipment purchased from Viavi after 2005-08-13 can be returned for disposal at the end of its useful life. Measuring systems affected by this can be recognized by the symbol on the right of a crossed-out trash can and a black bar. This symbol can be found either on the device or in the accompanying documents.



Contact your local Technical Assistance Center (TAC) for return and collection services available to you. If you would like specific information about the Viavi Environmental Management Program, please contact us at:

If you would like specific information about the Viavi Environmental Management Program, please contact us at www.viavisolutions.com.

The following page provides information with regard to the location of restricted hazardous substances within this equipment according to Chinese requirements.

As measuring equipment, this equipment is excluded from the European regulations for the restriction of hazardous substances (RoHS).

"中国RoHS"

《电子信息产品污染控制管理办法》（信息产业部，第39号） 附录 (Additional Information required for the Chinese Market only)

本附录按照"中国RoHS"的要求说明了有关电子信息产品环保使用期限的情况，并列出了产品中含有的有毒、有害物质的种类和所在部件。本附录适用于产品主体和所有配件。

环保使用期限：



本标识标注于产品主体之上，表明该产品或其配件含有有毒、有害物质（详情见下表）。

其中的数字代表在正常操作条件下至少在产品生产日期之后数年内该产品或其配件内含有的有毒、有害物质不会变异或泄漏。该期限不适用于诸如电池等易耗品。

有关正常操作条件，请参见产品用户手册。

产品生产日期请参见产品的原始校准证书。

有毒、有害物质的类型和所在部件

元器件 (Component)	有毒、有害物质和元素					
	铅 (Pb)	汞 (Hg)	镉 (Cd)	六价铬 (CR ⁶⁺)	多溴联苯 (PBB)	多溴二苯醚 (PBDE)
产品主体 (Main Product)						
印刷电路板组件 (PCB Assemblies)	X	O	O	O	O	O
内部配线 (Internal wiring)	O	O	O	O	O	O
显示器 (Display)	O	O	O	O	O	O
键盘 (Keyboard)	O	O	O	O	O	O
塑料外壳零件 (Plastic case parts)	O	O	O	O	O	O
配件 (Accessories)	O	O	O	O	O	O

O：代表该部分中所有均质材料含有的该有毒、有害物质含量低于SJ/T11363-2006标准的限值。
X：代表该部分中所有均质材料含有的该有毒、有害物质含量高于SJ/T11363-2006标准的限值。



North America
Latin America
China
Germany

+1 844-468 4284
+1 954 688 5660
+86 21 6859 5260
+49 7121 86 0

Viavi product specifications and descriptions in this document are subject to change without notice.
© 2016.01