

PNA-L Series Microwave Network Analyzers

The Standard in Microwave Network Analysis



Table of Contents

Complete Solutions for a Wide Range of Applications	3
Innovative Features Across the PNA Family	5
Connectivity to Match Your Application	6
Innovative Applications	9
On-Wafer Measurements	19
Completing the Solution	22
Ordering Information	24
Additional Resources	25

Complete Solutions for a Wide Range of Applications

2 ports	300 kHz to 8.5 GHz	<div style="background-color: #4CAF50; color: white; padding: 2px; text-align: center;">PNA-X</div> <div style="background-color: #FF9800; color: white; padding: 2px; text-align: center;">PNA</div> <div style="background-color: #9C27B0; color: white; padding: 2px; text-align: center;">PNA-L</div>
2, 4 ports	900 Hz /10 MHz to 8.5 GHz	
2, 4 ports	900 Hz /10 MHz to 13.5 GHz	
2, 4 ports	900 Hz /10 MHz to 13.5 GHz	
2, 4 ports	300 kHz to 13.5 GHz	
2, 4 ports	300 kHz to 20 GHz	
2, 4 ports	900 Hz/10 MHz to 26.5 GHz	
2, 4 ports	900 Hz/10 MHz to 26.5 GHz	
2, 4 ports	900 Hz /10 MHz to 43.5 GHz	
2, 4 ports	900 Hz /10 MHz to 43.5 GHz	
2 ports	10 MHz to 43.5 GHz	
2, 4 ports	900 Hz/10 MHz to 50 GHz	
2, 4 ports	900 Hz /10 MHz to 50 GHz	
2 ports	10 MHz to 50 GHz	
2, 4 ports	900 Hz/10 MHz to 67 GHz	
2, 4 ports	900 Hz/10 MHz to 67 GHz	
2, 4 ports	900 Hz/10 MHz to 1.5 THz ¹	
2, 4 ports	900 Hz/10 MHz to 1.5 THz ¹	

1. With frequency extenders

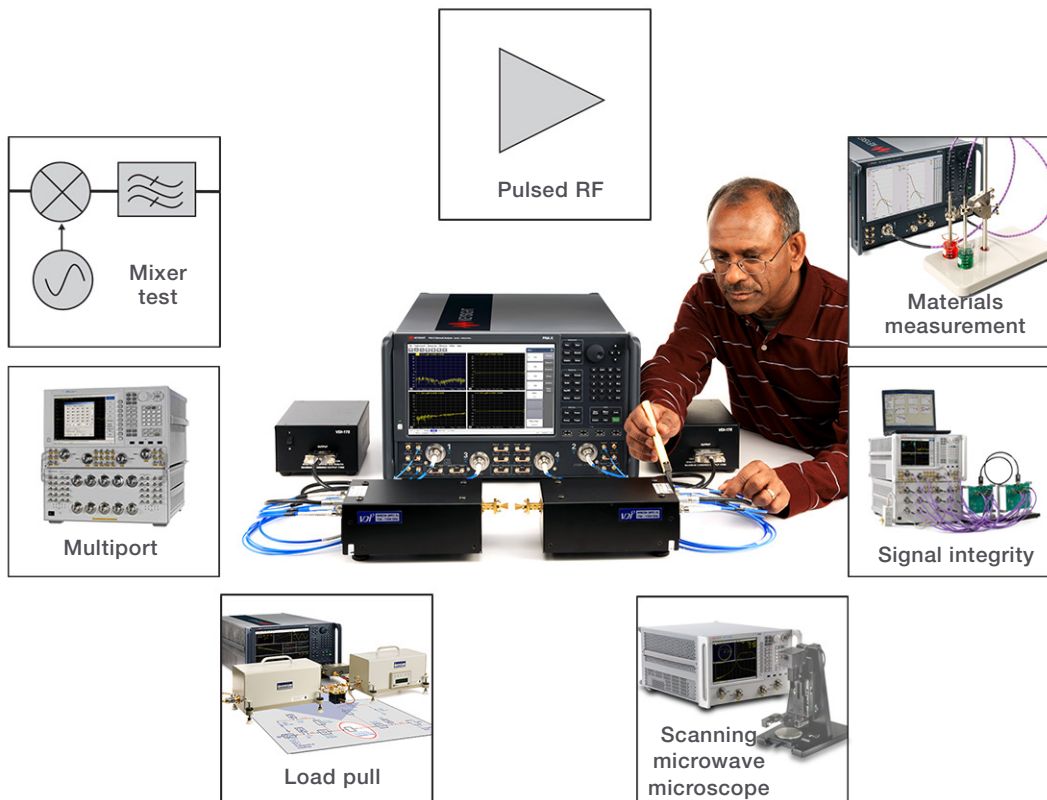

In addition to being very capable standalone network analyzers, PNA and PNA-L instruments often form the core of more advanced measurement systems to serve a variety of microwave measurement applications.

Future-proof your microwave component testing

All members of the PNA family share a common software platform that makes it easy to choose just the right level of performance to match your budget and measurement needs. This commonality guarantees measurement consistency and repeatability and a common remote-programming interface across multiple instruments in R&D and manufacturing. All of the powerful PNA software applications can be added later to meet future test requirements.



The PNA's built-in help system provides a complete user's guide, including measurement tutorials and programming documentation.

Innovative Features Across the PNA Family

Flexible, modern user interface: front panel keys, tabbed soft panel, pulldown menus, customizable toolbar, right-click shortcuts, drag-and-drop operation, and 12.1" touch screen

Up to 15 markers per trace

State-of-the-art calibration capabilities

200 measurement channels and unlimited traces

Context sensitive, built-in help

Undo/Redo cancels or restores previous entries



Configurable test set available on all models

Linear, log, power, CW, phase, and segment sweep

Equation editor and time-domain analysis

Quick access for ECal and other USB devices



PNA-L integrates a high resolution display with a touch screen, which provides a crisp view and easy access to all data and traces. This enhanced user interface allows intuitive operation and helps you set up complex measurements quickly.

Connectivity to Match Your Application

PNA-L Series provides basic connectivity

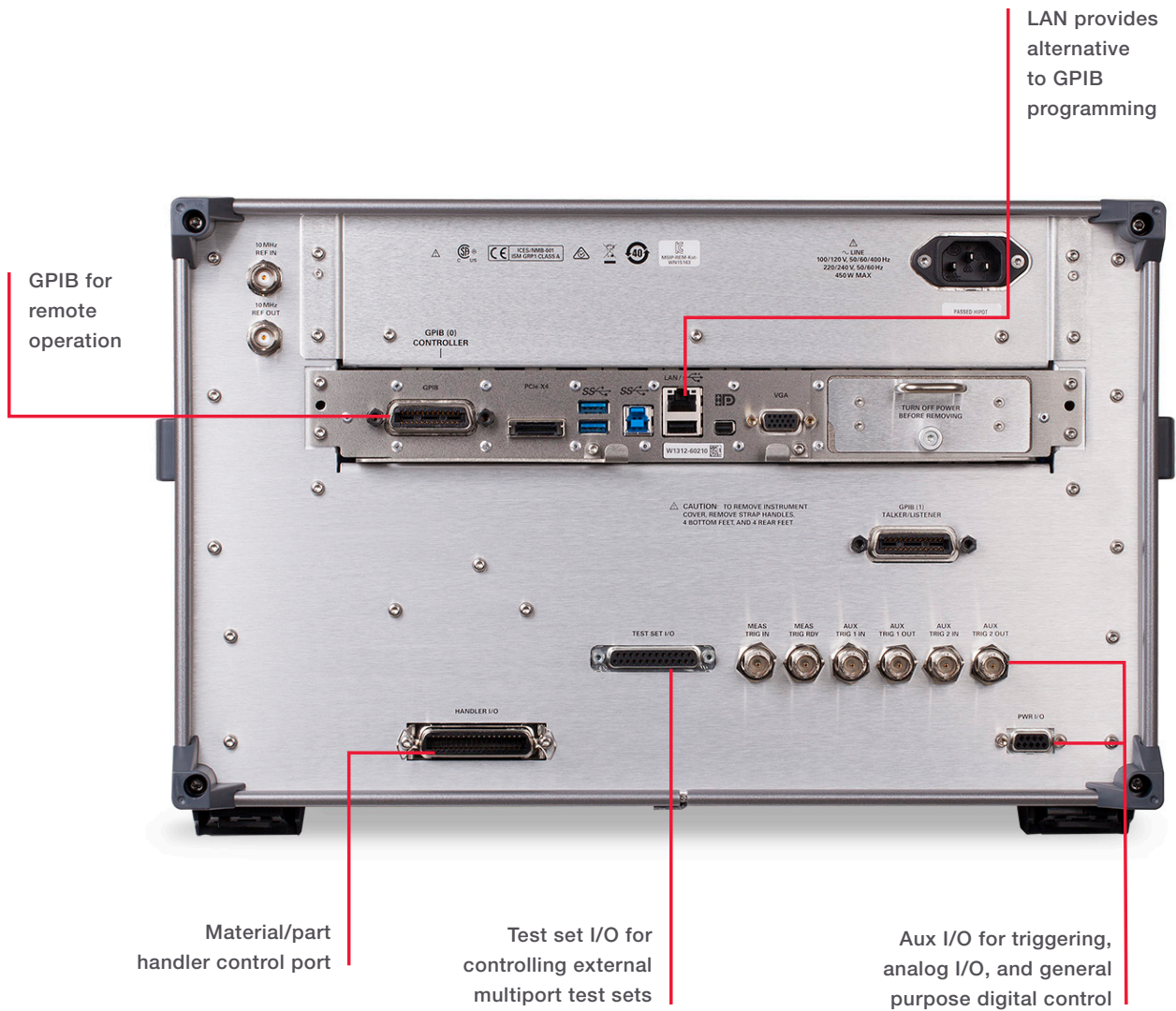

Passive and Active Device Test at Affordable Prices

The Keysight PNA-L is designed for your general-purpose network analysis needs and priced for your budget. With the same core firmware as the PNA, the PNA-L offers the perfect balance of value and performance. The PNA-L provides efficiency and flexibility in both manufacturing and R&D applications, for industries ranging from mobile-telecomm and wireless-LAN component production to aerospace and defense.

Balanced/differential components

For passive devices that have one or more balanced/differential ports, the PNA-L is an excellent choice for mixed-mode S-parameter measurements, without the need or limitations of using baluns.

- Display differential-, common-, and mixed-mode performance, in a variety of trace formats
- Measurement parameters include common-mode-rejection ratio and amplitude and phase imbalance
- Supported port configurations include single-ended-to-balanced and balanced-to-balanced topologies

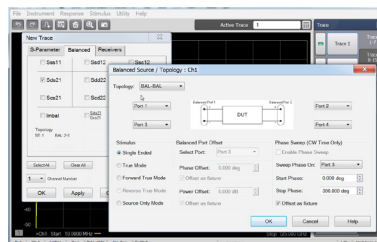
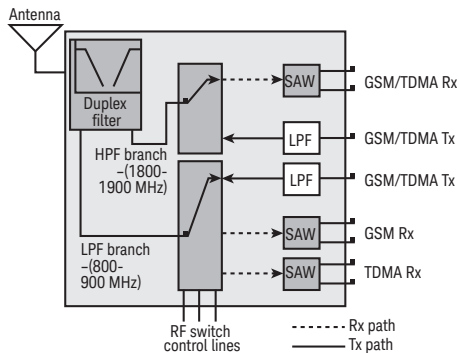
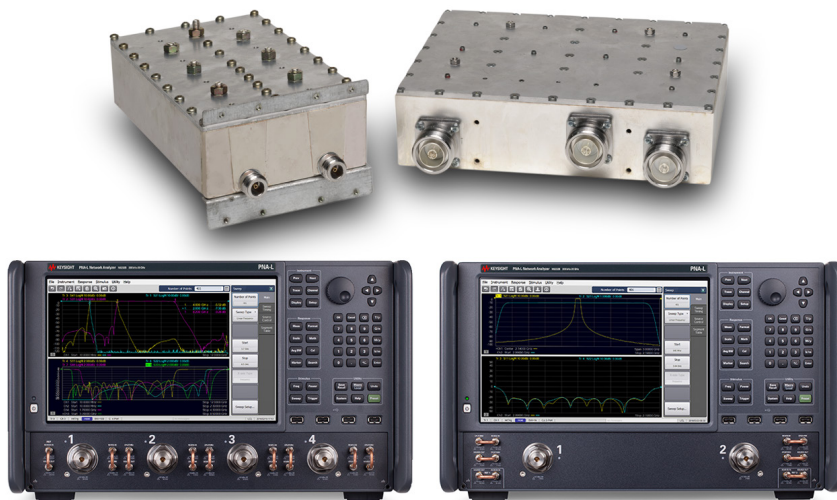

PNA-L Series Block Diagrams

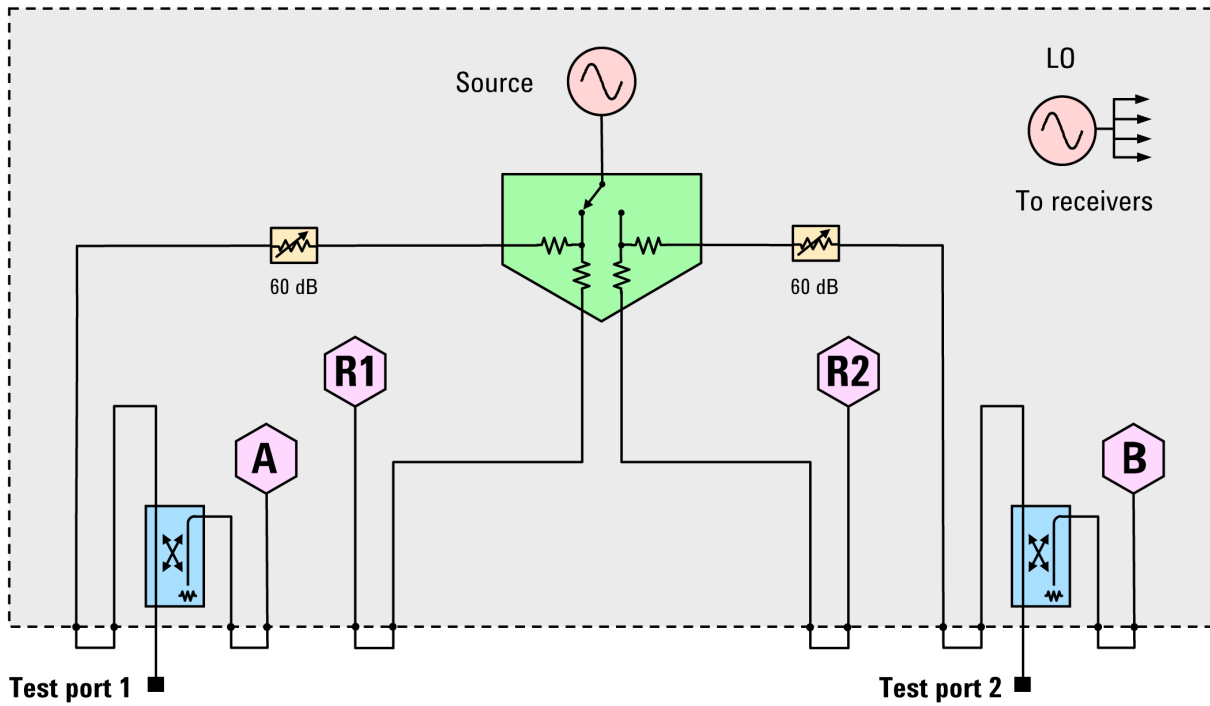

PNA-L Series 2-port block diagram shown with test set Option 216.

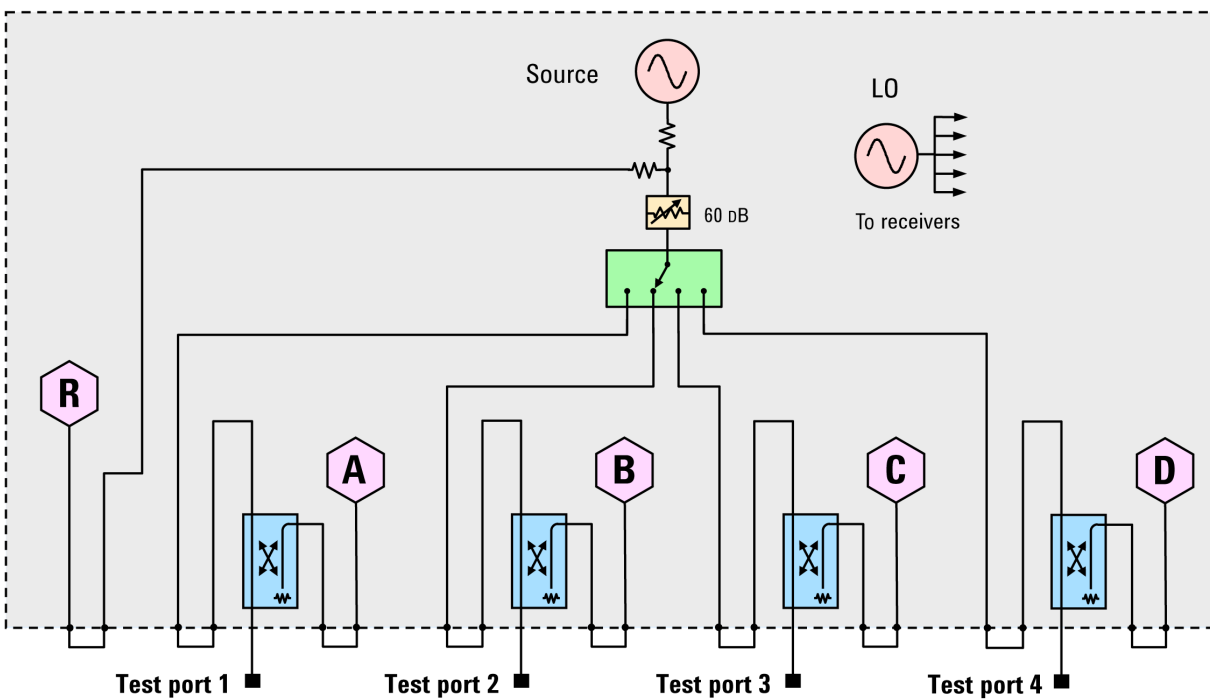

PNA-L Series 4-port block diagram shown with test set Option 416.

Innovative Applications

Powerful measurement setup assistance, Device Measurement eXpert (DMX) (S94601B/S94602B)

Measurement challenges

- Inexperienced users find it difficult to setup complex measurements
- PNA is so flexible/capable that the users need to have a lot of knowledge/experience to optimally set up the measurement.
- When making a number of different measurements for active devices (noise figure, gain compression, IMD...), there are many common settings that the users have to repeatedly configure for each measurement.
- The users need to know the limits of the instrument performance as well as the operating conditions of their DUTs to set up measurements in a safe and optimal manner.

Device Expert and S94601B DMX (Device Measurement eXpert) application

- Helps the users to set up the measurements automatically based on selected DUT. Device Expert, included with the base PNA software, provides three DUT types: low noise amplifier, mixer, and bandpass filter. The S94601B DMX provides many more DUT types than the built-in Device Expert. Once a DUT is selected the measurements and parameters configured in the template are listed. The users can modify the measurements and parameters using S94601B DMX or the DMX template editor.
- Assists the users in consistently configuring measurement settings throughout the design and test workflow by using a common template.
- Allows the users to create customized templates for their measurement needs.
- Provides intelligent algorithms that optimize measurement setups based on instrument and DUT performance limitations, protecting both the DUT and the instrument.

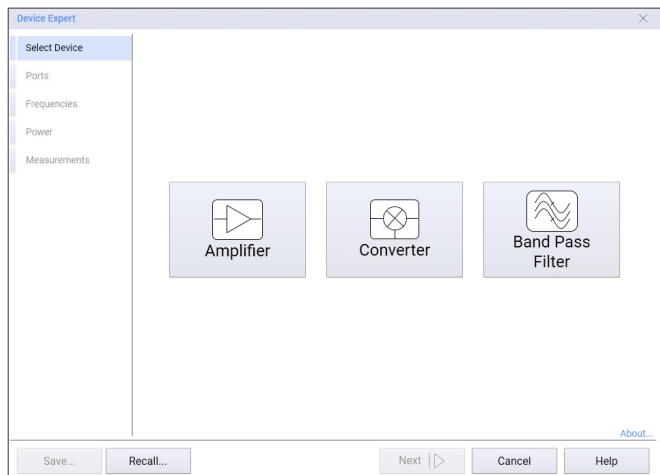
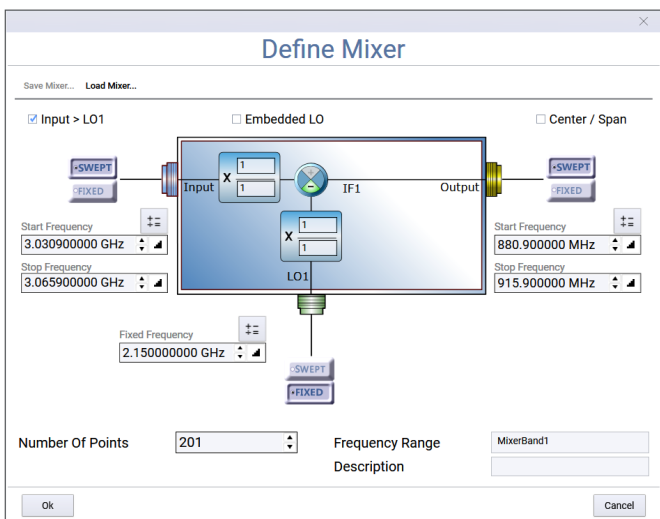
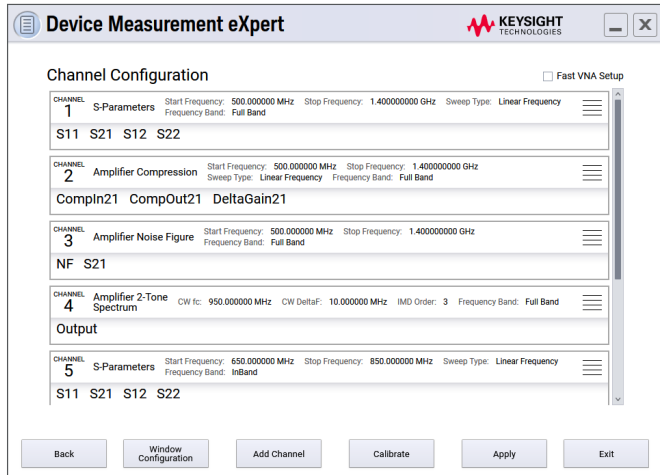

S96402B DMX Limit Assistant application

- Provides an intuitive and convenient graphical interface where users can create limit masks for complex limit test conditions for production test applications using data from a PNA or data file in csv, s2p, or prn format.

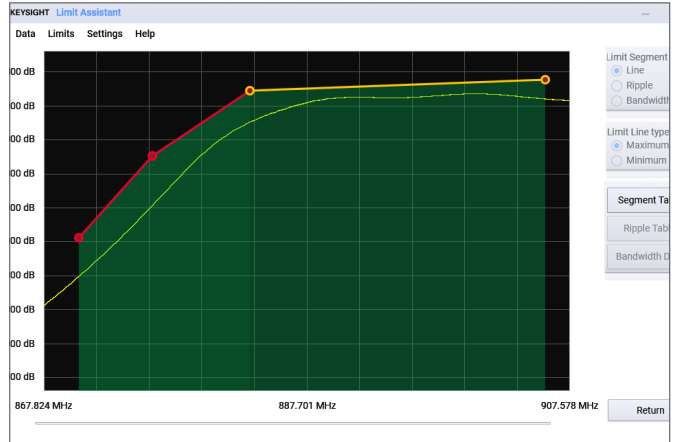

Innovative Applications

Real-time S-parameter and power measurement uncertainty (S93015B)

Product performance verification challenges

- Need to calculate the measurement uncertainty including multiple uncertainty factors
- Hard to optimize limit lines for pass/fail tests
- Quality control procedure is not simple due to complexity of quantifying the quality of the measurement process.

PNA-L's real-time S-parameter and power measurement solution

- Provides real-time S-parameters and power measurements uncertainty on the display
- Enables more realistic limit lines and reduce the defect percentage on the finished products for better production yield rates
- Includes the calibration standard uncertainty and provides the national metrology institute traceability
- Establishes a metric to quantify the quality of the measurement process for quality-control-procedure simplification
- Helps to include uncertainty information to the users' product specifications and datasheets
- Allows users to save measurement data and evaluate other parameters with fully correlated uncertainty

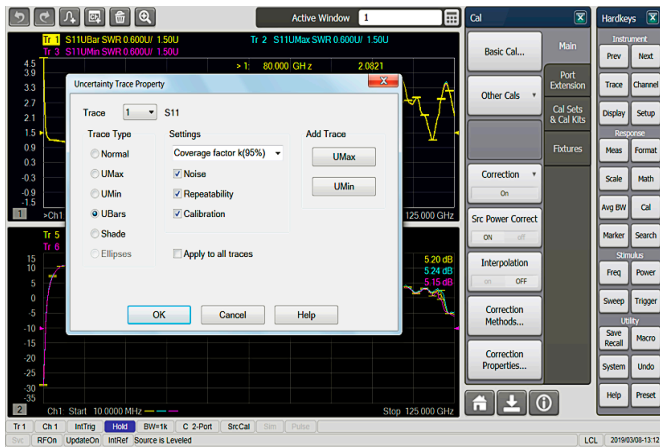

S93015B uncertainty model includes multiple uncertainty factors: noise, calibration standards, power sensor, and repeatability.

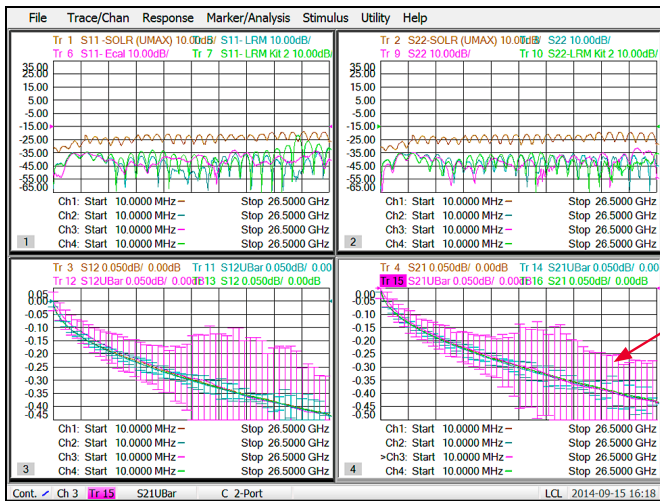

Real time uncertainty with measurement traces and uncertainty bars.

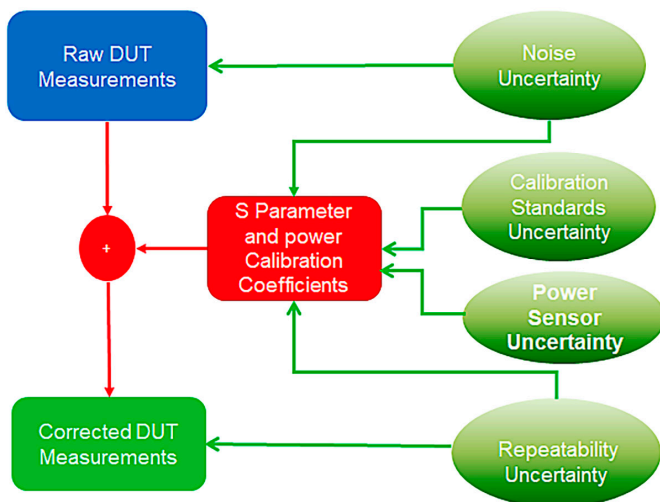

The users can select the uncertainty factors and the coverage factors depending on the application.



Tips from the experts

- Prior to using the uncertainty calibration, ensure that you have set up the correct number of points, IFBW and power for the device you want to measure. This will avoid invalidation of your uncertainties as a result of changing any of these parameters after doing a calibration.
- It is recommended that you do a standard calibration prior to using the Uncertainty Manager, as this will make it more efficient when you start the repeatability-characterization process.
- When using the uncertainty manager to characterize the repeatability of the measurement, consider providing a unique label for each port. This way you can save the noise and repeatability for each of the ports you will be using in the final measurement. As an example, use "Lab System Port 1" as the cable name, and assign the appropriate connector.
- When viewing 1-port uncertainties, it is best to use the linear format as opposed to the log format.

Innovative Applications

Fast multi-channel spectrum analyzer for component characterization (S93090xB)

Spectrum analysis challenges for component testing

- Measuring spurious performance is time consuming, especially when searching for low-level spurs over a broad frequency range
- Long measurement times may force insufficient test coverage
- Characterizing spurs over operating range of the DUT is tedious to accomplish or requires external control software

PNA-L spectrum analyzer (SA) application provides:

- Fast spurious searches over broad frequency ranges
- A multi-channel SA with internal swept-signal generators for efficient spurious analysis of mixers and converters
- In-fixture spectrum measurements using VNA calibration and de-embedding techniques
- Fast band- and noise-power measurements
- SA capability to the PNA-L's single-connection, multiple-measurement suite

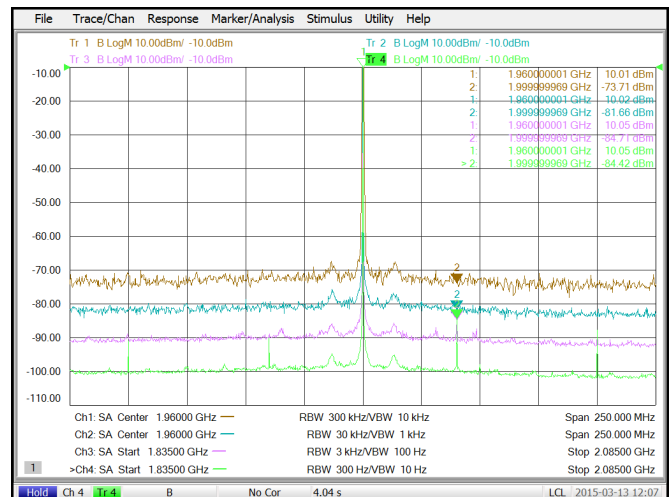
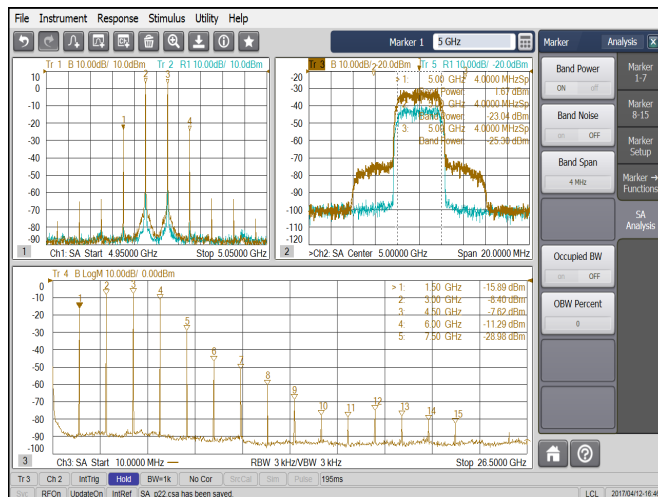

Spectrum analyzer option adds fast spur search capability to the PNA-L, replacing a standalone spectrum analyzer and switch matrix in component-characterization test systems.

Above plot shows -84 dBm spurious measurements in the presence of a +10 dBm signal, with (from top to bottom) approximate S/N (at RBW) of 80 dB (300 kHz), 90 dB (30 kHz), 100 dB (3 kHz), and 110 dB (300 Hz).

Providing multi-channel spectrum analysis

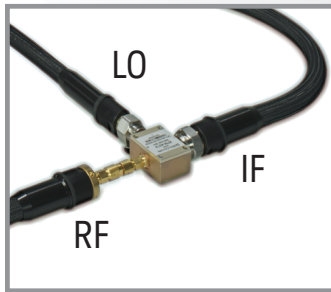
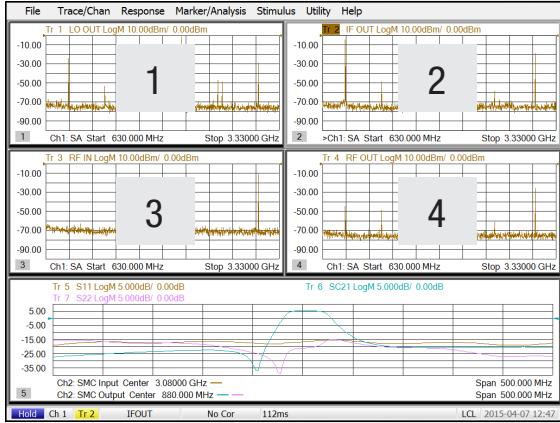

Having spectrum analyzers on all ports of a mixer or converter provides unparalleled insight into the performance of the device. With a single set of connections, the spurious content emanating from all

ports is readily apparent during operation with fixed or swept stimuli. Measured spurs can include LO, RF, and IF feedthrough, harmonics, intermodulation products, and other higher-order mixing products. Conversion loss and match versus frequency is easily seen in a companion SMC channel (bottom).

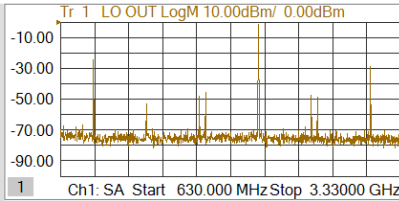

Output spectrum on LO port

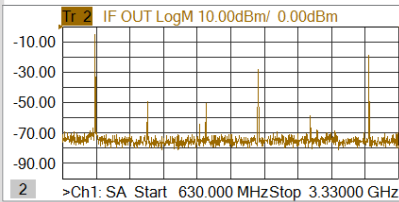

Output spectrum on IF port

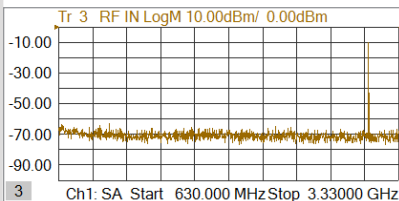

Input spectrum on RF port

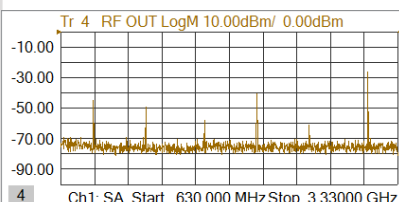

Output spectrum on RF port

Unlock true performance with VNA calibration

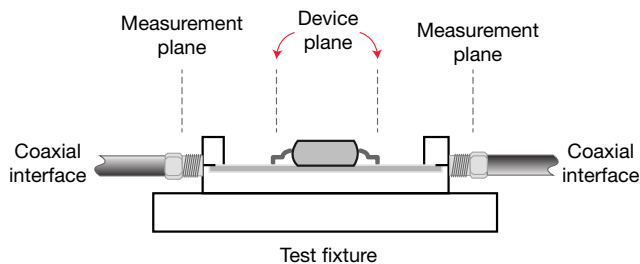
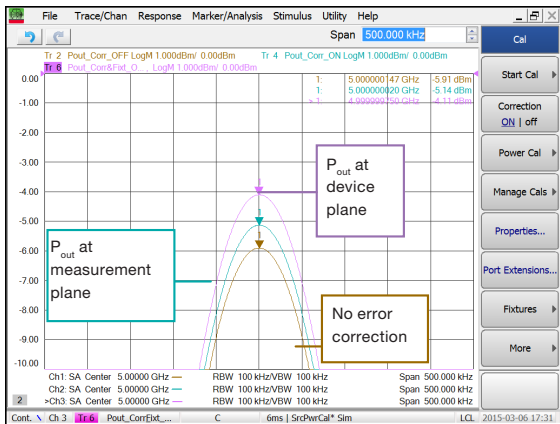

VNA calibration and fixture de-embedding remove cable and fixture effects and correct receiver response errors, providing calibrated in-fixture spectrum analysis.



Tips from the experts

- Choose different levels of software-image rejection to trade-off measurement speed with thoroughness, based on the spectral density of the measurement
- For harmonics measurements, add a separate SA channel for each harmonic with a narrow frequency span and RBW to optimize speed and sensitivity, and with enough receiver attenuation to avoid internally-generated harmonics
- To help identify spurious signals that might be interfering with a measurement, use the Marker-to-SA feature to easily create a spectrum display with the same stimulus conditions at the marker position in SMC, swept-IMD, or standard channels
- When using de-embedding to measure in-fixture or on-wafer devices, use the power-compensation feature to overcome the loss of the fixture or probes, thereby delivering a known stimulus power to the DUT

Innovative Applications

New capability of spectrum analysis application – Noise Power Ratio (NPR) measurements (S93090xB)

Challenges for amplifier noise power ratio (NPR) measurements

- It requires a spectrum analyzer for the analysis, and the measurement takes a long time due to the need for lots of averaging of random, noise-based signals
- It's difficult and time-consuming to correct the flatness of the multi-tone input stimulus
- The distortion floor in the notch may not be low enough, especially if a booster amplifier is used

The spectrum analysis application provides:

- Achieve fast and accurate NPR measurements with vector averaging of coherent, repetitive, multi-tone test waveforms
- Control external signal generators and AWGs to easily generate wideband modulated signals
- Quickly correct the power flatness of input signal
- Lower the distortion floor in the notches and adjacent channels with distortion-cancelling tones
- NPR measurement can be done as part of a single-connection-multiple-measurement setup with no cable changes



Tips from the experts

- NPR is sometimes used to estimate the EVM of an amplifier, without the need for full demodulation
- NPR can also be used to evaluate high-linearity devices such as Analog-to-Digital Converters (ADC) by providing a test signal with a dense spectrum, and a clear notch from which the ADC distortion can be seen
- The new NPR signal calibration can support correcting the signal at the output of an amplifier for power and flatness, while correcting the signal at the input for low-notch distortion. This is a great way to support NPR measurements for exact power at the output while maintaining a pure signal at the input of an amplifier-under-test

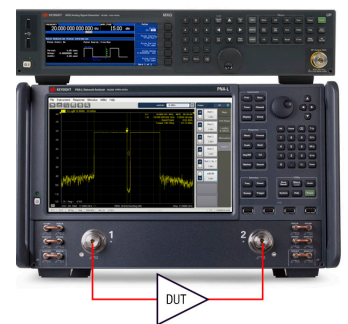
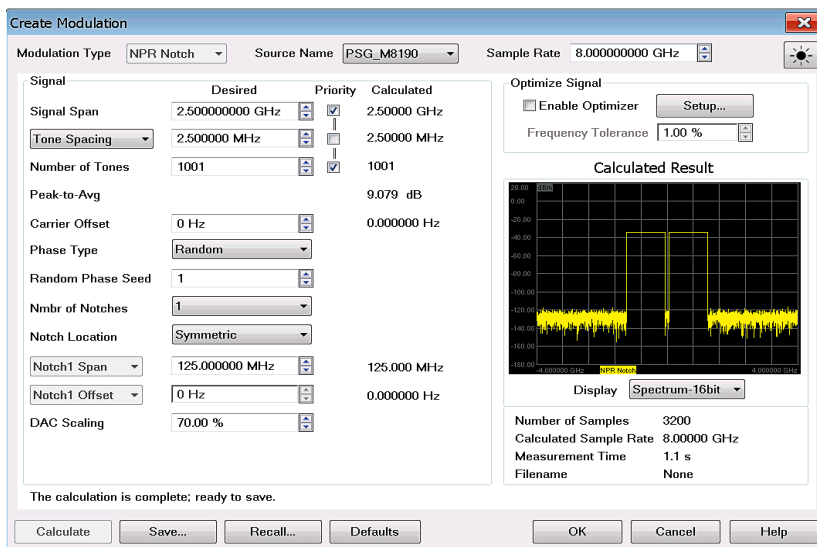

Classic NPR measurement with PNA-L and UXR

External signal generator wideband modulation signal creation on the PNA-L

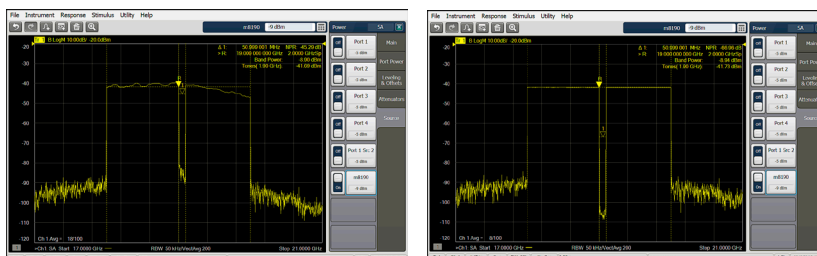

L: Before the signal correction

R: Improved flatness and lower noise floor in the notch after signal correction

Innovative Applications

Accurate characterization of mixers and converters (S93082B)

Mixer and converter measurement challenges

- Conventional VNAs provide phase or group delay data relative to a “golden” device
- Attenuators are often used to minimize ripple due to input and output mismatch, at the expense of dynamic range and calibration stability

PNA frequency converter applications provide:

- Typical measurement time improvement of 100x compared to spectrum analyzer-based approach
- Scalar mixer/converter (SMC) provides match and most accurate conversion loss/gain measurements by combining two-port and power-meter calibrations (S93082B)
- Input and output mismatch correction reduces ripple and eliminates the need for attenuators

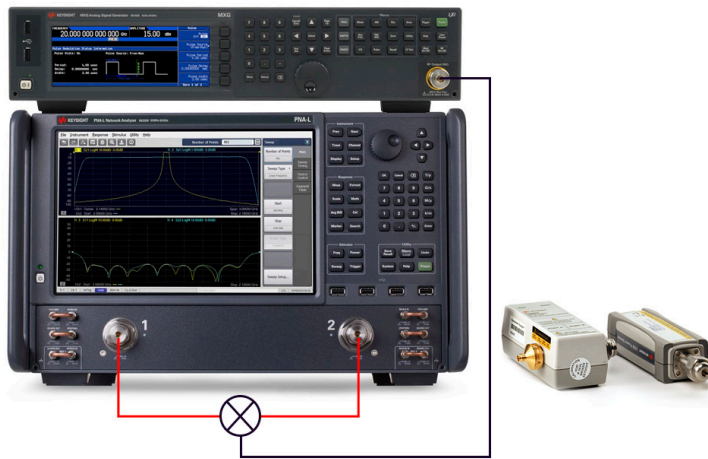

One-box solution for high-speed serial interconnect analysis (S93011B)

TDR measurement challenges

- As bit rates of digital systems increase, fast and accurate analysis of interconnect performance in both time and frequency domains is critical to ensure reliable system performance
- Managing multiple test solutions to completely characterize differential high-speed digital devices is difficult



PNA TDR application provides:

- One-box solution for high-speed interconnect analysis, including impedance, S-parameters, and eye diagrams

Simple and intuitive operation

- The user interface is designed to provide a similar look and feel to traditional TDR oscilloscopes

Fast and accurate measurements

- Accurate measurements due to unmatched performance of the PNA / PNA-L Series vector network analyzers
- State-of-the-art error correction techniques enables you to measure your device, not your measurement system

High ESD robustness

- Protection circuits implemented inside the instrument significantly increases ESD robustness, while at the same time maintaining excellent RF performance
- Highly robust architecture minimizes instrument failure from ESD and frees you from worrying about instrument repair fees and downtime

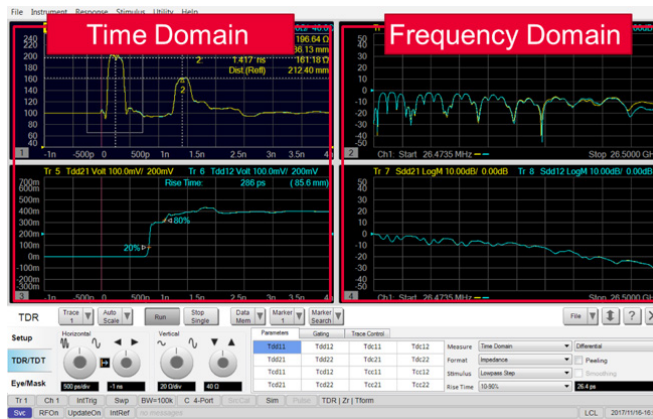

Measurements are taken as a function of frequency. The frequency domain information is used to calculate the Inverse Fourier Transform for time domain results.

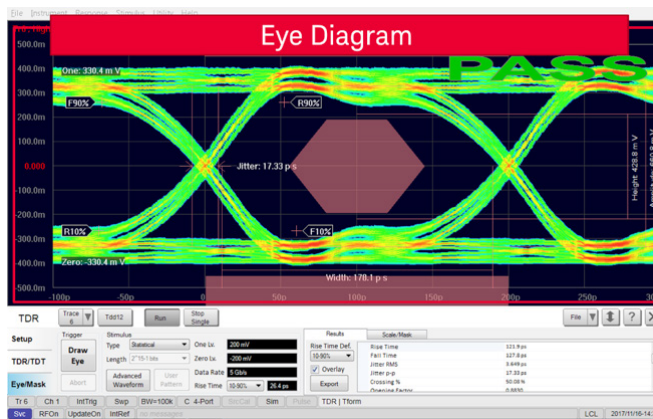

The simulated eye diagram analysis capability eliminates the need for a pulse pattern generator.

Innovative Applications

Physical Layer Test Software (PLTS)

The Keysight PNA-L is the ideal microwave engine to power PLTS software.

PLTS provides:

- Forward and reverse reflection and transmission measurements, with time- and frequency-domain displays targeted specifically for signal-integrity analysis
- Guided setup, calibration, and data acquisition
- Full modal analysis including single-ended, differential, and cross-mode conversions
- A powerful, virtual bit-pattern generator to create eye diagrams based on measured channel data
- Highly accurate RLCG models to enhance the accuracy of your models and simulations
- Automatic fixture removal for symmetric and asymmetric fixtures
- Advanced formula editor for user-defined equations such as power sums for crosstalk-compliance measurements

The screenshot displays the PLTS software interface with several analysis windows and toolbars. Red lines connect descriptive text boxes to specific features in the software.

- File and view management with the data browser:** Points to the top-left menu and toolbar area.
- Time domain analysis:**
 - $2n^2$ parameters
 - 7 formats
 - Time or distance
- Frequency domain analysis:**
 - $2n^2$ parameters
 - 8 formats
- Format, scaling, and marker control with easy access toolbars:** Points to the bottom toolbar area.
- Plot and trace management with context-sensitive parameter buttons:** Points to the plot area.
- Eye diagram analysis:**
 - $2n^2$ parameters
 - 8 formats
- RLCG model extraction:**
 - $2n^2$ parameters

PLTS provides a wealth of analysis tools for signal-integrity engineers.

Material measurements

Keysight offers several tools to help determine the intrinsic electromagnetic properties of materials, including N1500A materials measurement software, N1501A dielectric probe kit, 16451B/2A/3A/4A Material Test Fixture, N1501AExx Split Post Dielectric Resonator, and 85072A split cylinder resonator. The complete system is based on a versatile Keysight network analyzer like the PNA-L, LCR meters, and impedance analyzers, which measures the material's response to DC, RF or microwave energy.

Keysight material measurements solutions provide:

- Control of the network analyzer to automate complex permittivity and permeability measurements versus frequency
- Display of results in a variety of formats (ϵ_r' , ϵ_r'' , $\tan \delta$, μ_r' , μ_r'' , $\tan \delta_m$ and Cole-Cole)
- A variety of measurement methods and mathematical models to meet most application needs
- Support for many different probes and fixtures, as well as free-space measurements
- Data easily shared with other Windows-based programs or through the component object model (COM) interface

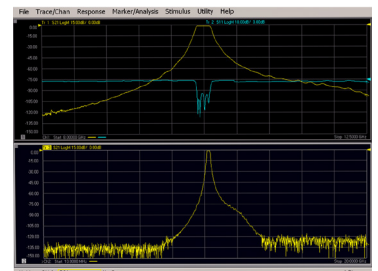

On-Wafer Measurements

PNA-L network analyzers can easily be integrated with a microwave probe station to form a complete on-wafer measurement system. When calibration requires a power sensor, the PNA firmware guides the user through the steps required to align power and S-parameter calibration planes into a single set of on-wafer reference planes.

On-wafer solutions provide:

- Measurements on filters, amplifiers, and frequency converters
- Complete set of TRL-class calibrations for accurate measurements
- Differential measurement capability using single-ended
- Accurate power-level control for precise power measurements
- Probe-characterization macro to easily measure S-parameters of probes for deembedding

Complete wafer-probe solutions from Cascade Microtech

Cascade Microtech is the worldwide leader for high-quality microwave probing systems and is an official Keysight Solutions Partner. Cascade offers a broad variety of test stations and probes to cover any application and frequency range. In addition, WinCal XE software enhances RF measurement accuracy and productivity through guided system setup, automatic calibration and validation, test sequencing, and other advanced RF measurement tools.

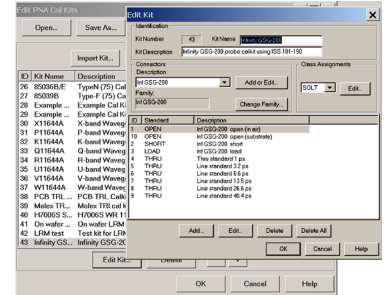

The PNA cal kit editor makes it easy to enter impedance-substrate standard (ISS) definitions for on-wafer calibration

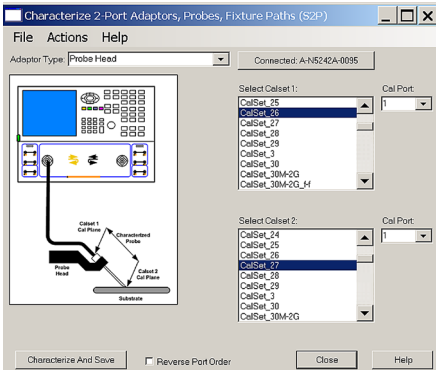
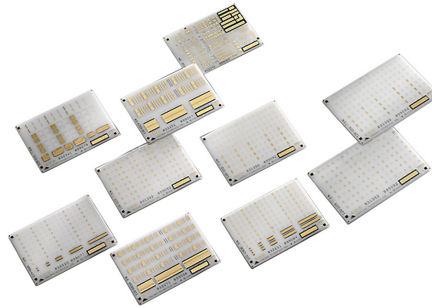
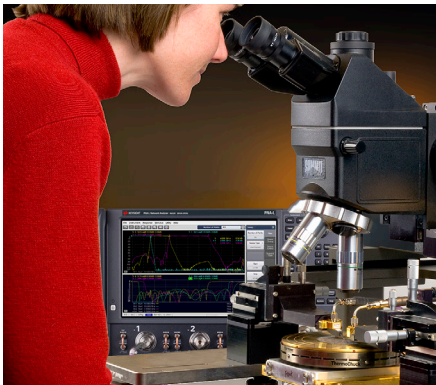

Extend the Power of the PNA Family to Multiport Devices

Multiport test challenges:

- Many components have more than 4 ports
- Moving test cables is slow and prone to errors
- Standard two-port calibration doesn't correct for ports outside the test path, resulting in degraded accuracy

PNA and PNA-L multiport solutions provide:

- Integrated test systems consisting of a network analyzer and an external multiport test set, seamlessly controlled by the PNA's firmware
- A single set of test connections to the DUT, resulting in high test throughput
- High accuracy with advanced calibration methods.
- Full compatibility with PLTS



Flexible test set hardware

- Test couplers on each port provide accurate and stable measurements
- External signal conditioning hardware such as attenuators, amplifiers, or isolators can be added as needed to handle a variety of device types
- Get full cross-bar switching to cover any DUT, or limit the test paths to match those required by a specific DUT

Advanced calibration

- N-port calibration corrects the load match at all ports of the DUT, whether they are in the test path or not. This gives a high level of accuracy, independent of the isolation between ports of the DUT.
- QSOLT (quick short, open, load, thru) calibration reduces the number of correction standards required for full N-port calibration

Select Calibration Ports and ECal Module

Ports to Calibrate

<input checked="" type="checkbox"/> Port 1	<input checked="" type="checkbox"/> Port 2	<input checked="" type="checkbox"/> Port 3	<input checked="" type="checkbox"/> Port 4
<input checked="" type="checkbox"/> Port 5	<input checked="" type="checkbox"/> Port 6	<input checked="" type="checkbox"/> Port 7	<input checked="" type="checkbox"/> Port 8
<input checked="" type="checkbox"/> Port 9	<input checked="" type="checkbox"/> Port 10	<input checked="" type="checkbox"/> Port 11	<input checked="" type="checkbox"/> Port 12
<input checked="" type="checkbox"/> Port 13	<input checked="" type="checkbox"/> Port 14	<input checked="" type="checkbox"/> Port 15	<input checked="" type="checkbox"/> Port 16

Select All
Clear All

ECal Configuration

Selected Cal Kit: N4691-60001
Serial No.: 00141
Characterization: Factory

View/Select ECal Module

Show Advanced Settings (Orientation & Thru Cal Section)
 Calibrate source and receiver power

< Back Next > Cancel Help

Completing the Solution

Advanced calibration tools

Calibrating network analyzers is critical for high accuracy measurements and can be particularly challenging in non-coaxial environments such as in-fixture, on-wafer, or waveguide. The PNA family supports a broad range of mechanical and electronic calibration kits, and offers advanced calibration methods to enhance ease-of-use while providing best-in-class accuracy. Keysight calibration tools include:

- High-performance two-and four-port ECal modules, covering 300 kHz to 67 GHz, with nine connector types
- QSOLT and n-port calibration for multiport test systems
- Data-based calibration-standard models and expanded math for enhanced accuracy at high frequencies
- Match-corrected power measurements to eliminate mismatch errors
- Software fixturing for deembedding, port matching, and impedance transformation



Protect your software investment

Keysight protects your 8753, 8720 and 8510 software investment by providing migration tools to reduce your code conversion effort.

www.keysight.com/find/nadisco

Network analyzer forum

Visit the online network analyzer discussion forum where you can learn how your peers are solving some of their most challenging measurement problems.

www.keysight.com/find/na_forum

Application notes

More information about PNA network analyzer applications can be found at

www.keysight.com/find/pnaapps

Keysight Software Licensing Options Provide Flexibility and Support

Projects ramp up and down, teams grow and shrink, and projects move location. In such a dynamic environment, you need flexible licensing options that allow you to balance your project's requirements. Whether your software will be a staple for years to come or you have a short-term need for a leading-edge measurement application, Keysight's licensing puts you in charge.

Choose your term. Choose your type. Keep control of your budget.

- Select a node-locked, transportable, USB portable or floating license type, depending on how much flexibility you need.
- Select a subscription or perpetual license term, depending on how long you need to use the software.
- Each license is sold with a KeysightCare software support, which provides technical support with ensured response time, proactive software updates, and enhancements.

Choose a license term and type that best suits your requirements from the table below.

License Term	Options
Perpetual	Licenses can be used indefinitely.
Subscription	Licenses can be used through the term of the subscription (6, 12, 24, or 36 months).

Table 1. License term

License Type	Descriptions
Node locked	License can be used on one specified instrument/computer.
Transportable	License can be used on one instrument/computer at a time but may be transferred to another using Keysight Software Manager (internet connection required).
USB portable	License can be used on one instrument/computer at a time but can be transferred to another using a certified USB dongle (available for additional purchase, Keysight part number E8900-D10).
Floating	Networked instruments/computers can access a license from a server one at a time. Multiple licenses may be purchased for concurrent usage. Three types of floating license are available: Single Site: 1-mile radius from the server Single Region ¹ : Americas, Europe, Asia Worldwide (export restriction identified in End User License Agreement (EULA))

1. Americas (North, Central, and South America, Canada); Europe (European Continent, Middle Eastern Europe, Africa, India); Asia (North and South Asia Pacific Countries, China, Taiwan, Japan)

Table 2. License type

KeysightCare Software Support Subscription provides peace of mind amid evolving technologies.

- Ensure your software is always current with the latest enhancements and measurement standards.
- Gain additional insight into your measurement problems with live access to our team of technical experts.
- Stay on schedule with fast turnaround times and priority escalations when you need support.

Subscription	Descriptions
KeysightCare software support	Perpetual licenses are sold with a 12 (default), 24, 36, or 60-month software support subscription. Support subscriptions may be renewed for a fee after that. Software subscription licenses include software support through the term of the license.

Table 3. KeysightCare software support subscription

Ordering Information

- Step 1. Choose your software product.
- Step 2. Choose your license term: perpetual or subscription
- Step 3. Choose your license type: node-locked, transportable, USB portable, or floating.
- Step 4. Depending on the license term, choose your subscription or support duration.

Product	License Type	License Term			
		Perpetual		Subscription	
	License	Support	License & Support		
S93xxxB/ S94xxxB	Node-locked (fixed)	R-A5A-001-A	+	R-A6A-001-z	R-A4A-001-z
	Transportable	R-A5A-004-D	+	R-A6A-004-z	R-A4A-004-z
	USB Portable ¹	R-A5A-005-E	+	R-A6A-005-z	R-A4A-005-z
	Floating (single site)	R-A5A-002-B	+	R-A6A-002-z	R-A4A-002-z
	Floating (single region)	R-A5A-006-F	+	R-A6A-006-z	R-A4A-006-z
	Floating (worldwide)	R-A5A-010-J	+	R-A6A-010-z	R-A4A-010-z
		z = Duration		z = Duration	
		L	12 months (default) ²	F	6 months
		X	24 months	L	12 months
		Y	36 months	X	24 months
		Z	60 months	Y	36 months

1. USB portable license requires a certified USB dongle (available for additional purchase, Keysight part number E8900-D10)
2. For S93xxxB software, the fixed-perpetual with a 12-months, support subscription (R-A6A-001-L) is the only license type that can be ordered as part of the instrument and installed. The other license types for S93xxxBs and all license types for S94601B/2B must be ordered separately and installed from the web after the receipt of the instrument.

Additional Resources

- www.keysight.com/find/accessories
- www.keysight.com/find/antenna
- www.keysight.com/find/ecal
- www.keysight.com/find/materials
- www.keysight.com/find/multiport
- www.keysight.com/find/plts
- www.keysight.com/find/pna
- www.keysight.com/find/pulsedrf

Learn more at: www.keysight.com

For more information on Keysight Technologies' products, applications or services, please contact your local Keysight office. The complete list is available at: www.keysight.com/find/contactus

