

**INSTRUCTION MANUAL**  
**for**  
**ACTIVE**  
**LOOP ANTENNA**  
(with Remote Interface Option)

Model: **AL-130R**

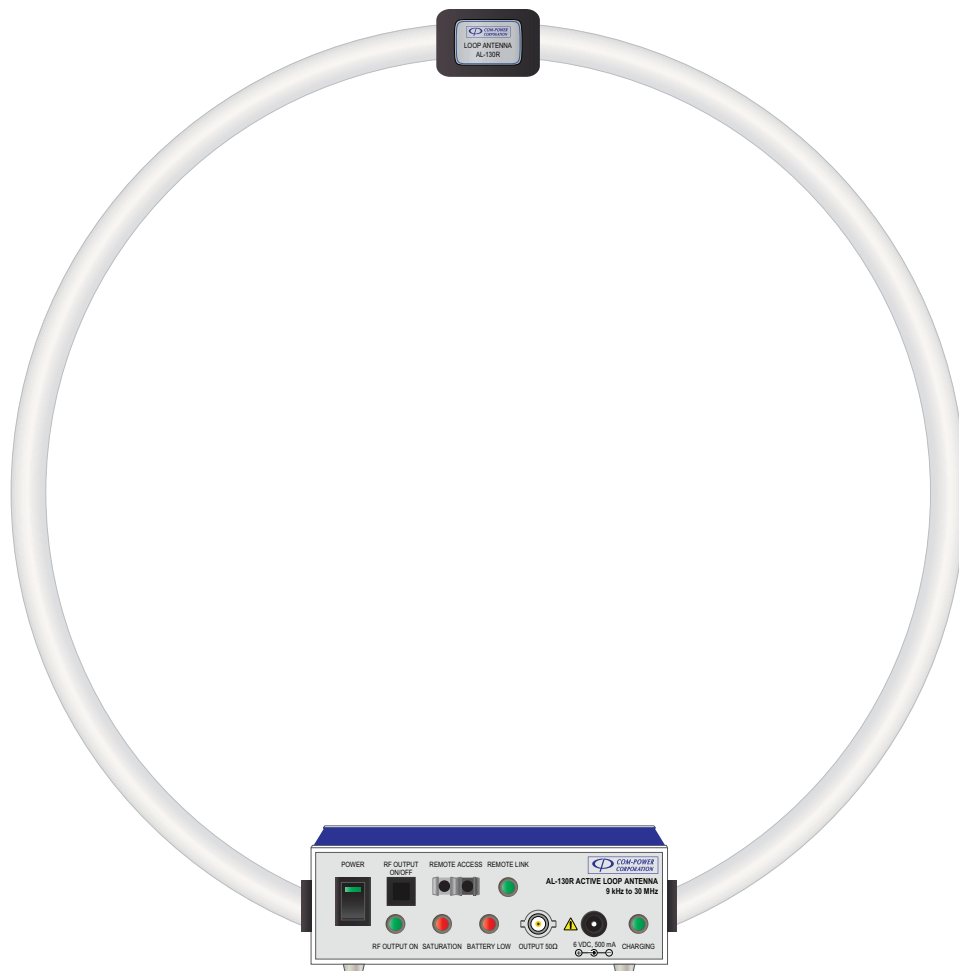

---

## Table of Contents

<b>1.0 Introduction .....</b>	<b>4</b>
<b>2.0 Products Available from Com-Power .....</b>	<b>5</b>
<b>3.0 Product Information .....</b>	<b>6</b>
3.1 Incoming Inspection .....	6
3.2 Package Inventory .....	6
3.3 Product Safety Information .....	7
3.3.1 Product Hazard Symbols Definitions.....	7
3.3.2 Product Warning/Caution Statements.....	7
3.3.3 General Safety Instructions.....	7
3.4 Product Connections/Controls.....	8
3.5 Product Specifications .....	11
<b>4.0 Measurement Correction Factors .....</b>	<b>13</b>
4.1 Antenna Factors.....	14
4.2 Preamplifier Gain Factors .....	14
4.3 Insertion Loss Factors.....	15
4.3.1 Insertion Loss Measurement.....	16
4.3.1.1 Insertion Loss Measurement Procedure.....	16
<b>5.0 Using your AL-130R Loop Antenna .....</b>	<b>17</b>
5.1 Field Strength Measurement Calculations.....	17
5.2 Antenna Positioning.....	19
5.3 Using RAI-100 Remote Antenna Interface Unit .....	20
<b>6.0 Calibration and Re-Calibration .....</b>	<b>20</b>
<b>7.0 Warranty.....</b>	<b>22</b>

## List of Figures

FIGURE 1 -	AL-130R Connections/Controls Diagram – Front Panel	8
FIGURE 2 -	AL-130R Connections/Controls Diagram – Rear Panel	9
FIGURE 3 -	AL-130R Battery Access & Tripod Mounting Hole - Bottom Panel	9
FIGURE 4 -	RAI-100 Connections/Controls Diagram	10
FIGURE 5 -	AL-130R Active Loop Antenna Dimensions	12
FIGURE 6 -	RAI-100 Remote Antenna Interface Dimensions	12
FIGURE 7 -	Setup for Reference Measurements (R)	16
FIGURE 8 -	Setup for Insertion Loss Measurements (I)	16
FIGURE 9 -	Typical measurement system for AL-130R	17
FIGURE 10 -	Rotation of Loop about its Vertical Axis	19
FIGURE 11 -	Rotation of Loop about its Horizontal Axis	19
FIGURE 12 -	Fiber Optic Connection from AL-130R to RAI-100	20

## 1.0 Introduction

This manual includes descriptions of front and rear panel ports, controls and indicators; product specifications, safety precautions, operational instructions, measurement guidelines and warranty information.

Information contained in this manual is the property of Com-Power Corporation. It is issued with the understanding that the material may not be reproduced or copied without the express written permission of Com-Power.

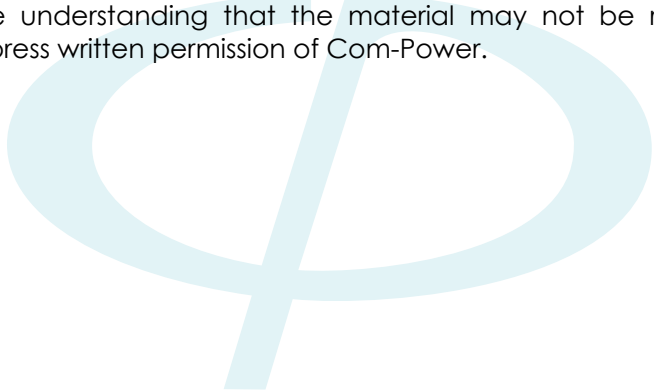

## 2.0 Products Available from Com-Power



*Antennas*



*Antenna Kits*



*Absorbing Clamps*



*Coupling/Decoupling  
Networks (CDN)*



*Comb Generators*



*Current Probes*



*Emissions Test  
Systems*



*Conducted Immunity  
Test Systems*

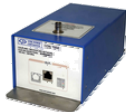

*Impedance Stabilization  
Networks (ISN)*



*Line Impedance Stabilization  
Networks (LISN)*



*Antenna Masts*



*Near-Field  
Probe Sets*



*Preamplifiers*



*Power Amplifiers*

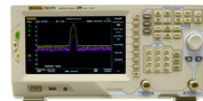

*Spectrum Analyzers*



*Product Safety Test  
Equipment*



*Transient Limiters*



*Turntables*



*Antenna Tripods*



*Telecom Test  
Systems*

[www.com-power.com](http://www.com-power.com)

## 3.0 Product Information

### 3.1 Incoming Inspection

**WARNING** – To avoid possibility of electrical shock, do not apply power to the Com-Power AL-130R Active Loop Antenna if there is any evidence of shipping damage. If shipping damage to the product or any its accessories is suspected, or if the package contents are not complete, contact Com-Power or your Com-Power distributor.

Please check the contents of the shipment against the package inventory in section 3.2 to ensure that you have received all applicable items.

### 3.2 Package Inventory

**STANDARD ITEMS:**

- ✓ AL-130R Active Loop Antenna
- ✓ 6 VDC (unregulated), 500 mA Battery Charger / AC Power Adapter

**OPTIONAL ITEMS:**

- ✓ RAI-100 Remote Antenna Interface
- ✓ Fiber Optic Cable
- ✓ 6 VDC (unregulated), 500 mA, AC Power Adapter

## 3.3 Product Safety Information

### 3.3.1 Product Hazard Symbols Definitions

The hazard symbols appearing on the product exterior are defined below.



The yellow triangle with an exclamation mark indicates the presence of important operating and/or maintenance (servicing) instructions in the literature accompanying the product.

### 3.3.2 Product Warning/Caution Statements

**WARNING:** TO PREVENT ELECTRIC SHOCK, DO NOT OPEN COVER. SERVICING ONLY BY QUALIFIED PERSONNEL. NO USER SERVICEABLE PARTS INSIDE

**CAUTION:** FOR CONTINUED PROTECTION AGAINST RISK OF FIRE, REPLACE ONLY WITH THE SAME TYPE AND RATING OF FUSE.

### 3.3.3 General Safety Instructions

The following safety instructions have been included in compliance with safety standard regulations. Please read them carefully.

- **READ AND RETAIN INSTRUCTIONS** - Read all safety and operating instructions before operating the instrument. Retain all instructions for future reference.
- **HEED WARNINGS** - Adhere to all warnings on the instrument and operating instructions.
- **FOLLOW INSTRUCTIONS** - Follow all operating and use instructions.
- **WATER AND MOISTURE** - Do not use the instrument near water.
- **WALL OR CEILING MOUNTING** - Do not mount the instrument on a wall or ceiling.
- **HEAT** - The instrument should be situated away from heat sources such as heat registers or other instruments which produce heat.
- **POWER SOURCES** - Connect the instrument only to the type of power source described in the operating instructions or as marked on the instrument.
- **POWER CORD PROTECTION** - Place power supply cords so that they are not likely to be walked on or pinched by items placed on them or against them.
- **CLEANING** - Clean the instrument only as recommended by the manufacturer.
- **DEFECTS AND ABNORMAL STRESS** - Whenever it is likely that the normal operation has been impaired, make the equipment inoperable and secure it against further operation.
- **DAMAGE REQUIRING SERVICE** - Instrument should be serviced by qualified personnel when:
  - ✓ The power supply cord or the plug has been damaged.
  - ✓ Objects have fallen or liquid has been spilled into the instrument.
  - ✓ The instrument has been exposed to rain.
  - ✓ The instrument does not appear to operate normally.
  - ✓ The instrument has been dropped, or the enclosure has been damaged.
- **SITTING OR CLIMBING** - Do not sit or climb upon the instrument or use it as a step or ladder.

### 3.4 Product Connections/Controls

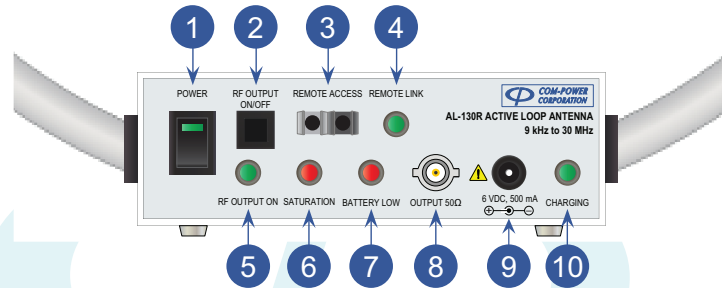

**FIGURE 1 - AL-130R Connections/Controls Diagram – Front Panel**

- 1 Main Power Switch and LED Indicator**  
Turns on/off all loop antenna interface/control circuits, but NOT internal amplifier (standby mode)
- 2 RF Output ON/OFF Toggle Switch**  
Turns on/off loop antenna amplifier circuit
- 3 Remote Access Port**  
Fiber optic port for connection to RAI-100 Remote Antenna Interface
- 4 Remote Link LED Indicator**  
Indicates active connection with RAI-100 Remote Antenna Interface
- 5 RF Output On LED Indicator**  
Indicates that RF amplifier circuit is active
- 6 Saturation LED Indicator**  
Indicates that the amplifier is in saturation
- 7 Battery Low Indicator**  
Indicates that the battery level is getting low, and will soon require charging
- 8 Antenna Output Port**  
50 ohm coaxial port for connection to measuring instrument
- 9 Power Input Port**  
Power input port for connection of provided battery charger / AC adapter
- 10 Battery Charging Indicator**  
Indicates that the internal battery pack is being charged



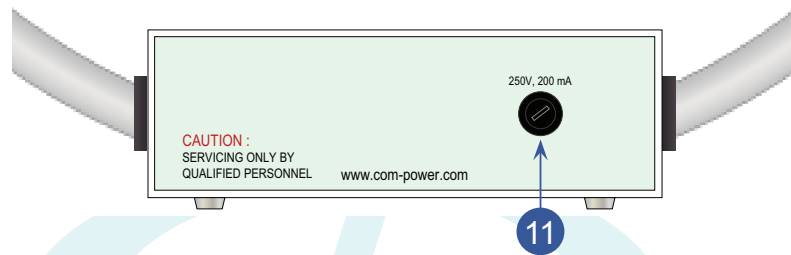

**FIGURE 2 - AL-130R Connections/Controls Diagram – Rear Panel**

- 11 Fuse Mounting Assembly**  
Provides access to input power fuse

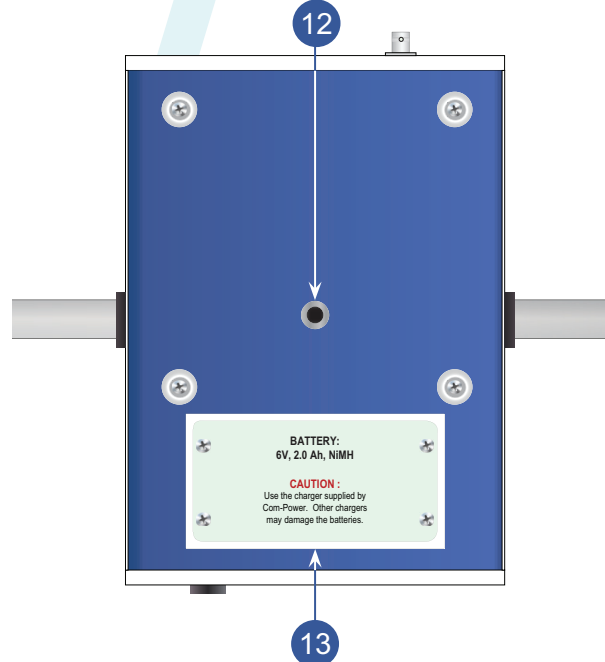

**FIGURE 3 - AL-130R Battery Access & Tripod Mounting Hole - Bottom Panel**

- 12 Antenna Mounting Hole (1/4" x 20 threads per inch)**  
For mounting loop antenna to tripod or other mounting structure
- 13 Battery Access Panel**  
Provides access to internal battery packs

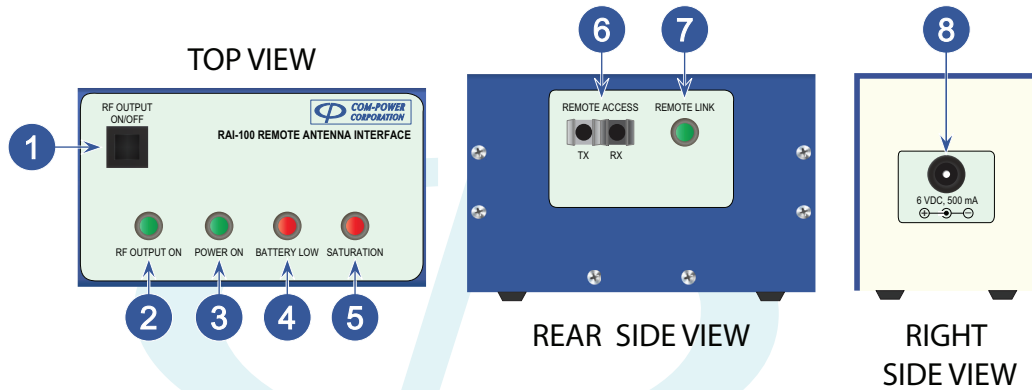

**FIGURE 4 - RAI-100 Connections/Controls Diagram**

- 1 RF Output ON/OFF Toggle Switch**  
Turns on/off loop antenna amplifier circuit
- 2 RF Output On LED Indicator**  
Indicates that RF amplifier circuit is active
- 3 Power On LED indicator**  
Indicates that the loop antenna interface/control circuitry is powered (stand-by mode)
- 4 Battery Low Indicator**  
Indicates that the battery level is getting low, and will soon require charging
- 5 Saturation LED Indicator**  
Indicates that the amplifier is in saturation
- 6 Remote Access Port**  
Fiber optic port for connection to AL-130R Loop Antenna
- 7 Remote Link LED Indicator**  
Indicates active connection with AL-130R Loop Antenna
- 8 Power Input Port**  
Power input port for connection of provided AC adapter

### 3.5 Product Specifications

#### Technical

Product	<b>Active Loop Antenna w/Remote Interface</b>
Frequency Range	<b>9 kHz to 30 MHz</b>
Standard(s)	<b>ANSI C63.4, CISPR 11/EN 55011, etc.</b>
Loop Outside Diameter	<b>19.7"</b> (50 cm)
Output Impedance	<b>50Ω</b> (nominal)
H-Field Antenna Factors	<b>-38.1 to -36.1</b> (average: 38.6) [dB(Ω/m)]
E-Field Antenna Factors	<b>13.4 to 16.4</b> (average: 14.9) [dB(m <sup>-1</sup> )]
Saturation Level	<b>&gt;1 V/m/&gt;120 dBμV/m</b> (>2.65 mA/m/>68.5 dBμA/m)

#### Electrical

DC Power Input	<b>6 V<sub>DC</sub></b>
AC to DC Power Adapter	<b>6 V<sub>DC</sub> (unregulated), 500 mA</b>
Fuse Type	<b>250V, 200 mA, Type T</b>
Battery Pack	<b>6 V<sub>DC</sub> 2.0 Ah, NiMH</b> (rechargeable)
Typical Battery Life	<b>10-12 hours</b> (new, fully charged battery)

#### RF Connectors

Antenna Port Connector	<b>BNC-type</b> (female)
Power Input Port	<b>5.5/2.5 mm Power Jack</b>
Fiber Optic Connector	<b>Avago Duplex Latching POF jack</b>

#### Mechanical

Dimensions (H)x(W)x(D)	<b>20.35" x 19.7" x 10.9"</b> (51.7 x 50 x 27.7 cm)
Weight	<b>5.5 lbs</b> (2.5 kg)

#### Environmental

Operating Temperature	<b>40°F to 104°F</b> (5°C to 40°C)
-----------------------	------------------------------------

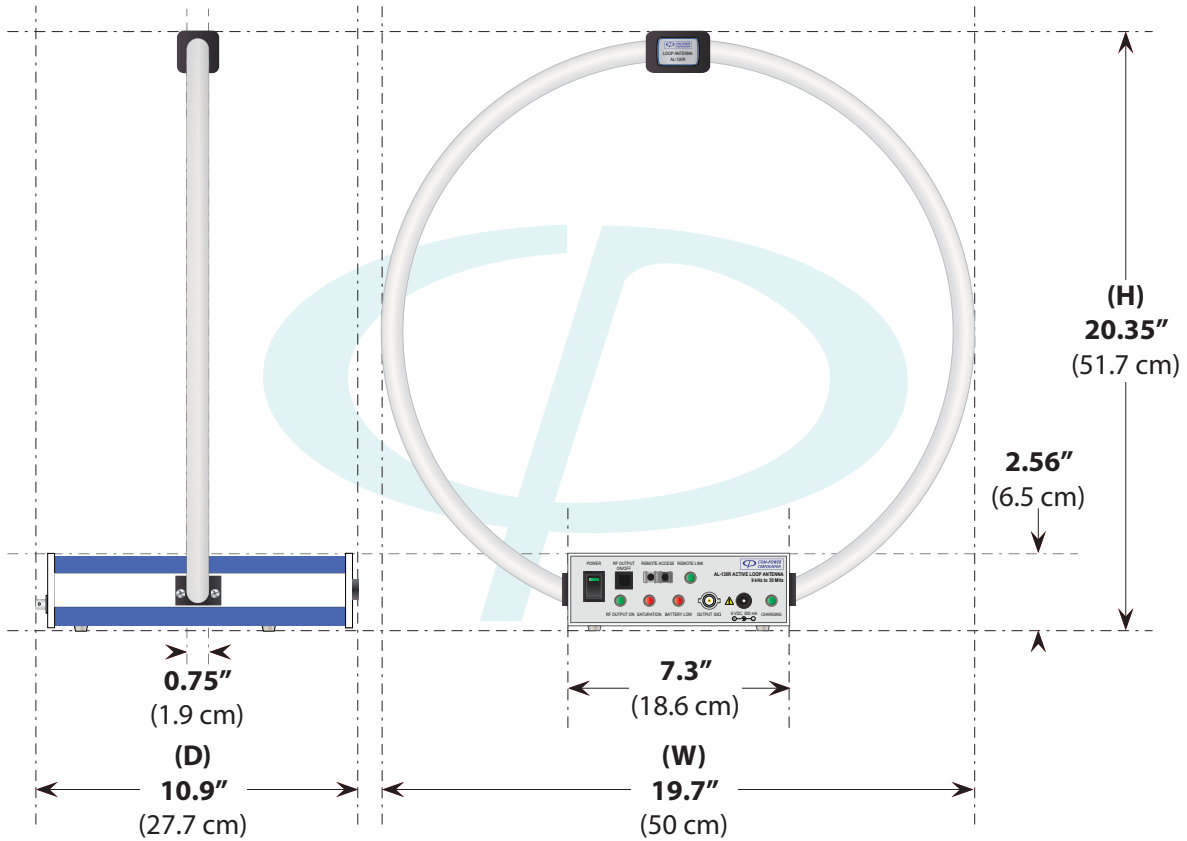

**FIGURE 5 - AL-130R Active Loop Antenna Dimensions**

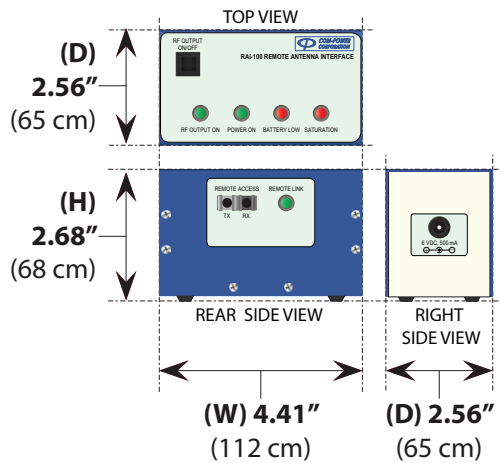

**FIGURE 6 - RAI-100 Remote Antenna Interface Dimensions**

## 4.0 Measurement Correction Factors

Anyone familiar with EMI radiated emissions measurements understands that 'uncorrected' values measured on your spectrum analyzer or EMI receiver are essentially meaningless without the appropriate 'correction' factors for the individual components of your measurement system.

A typical radiated emissions measurement system can include any combination of the following components, all of which have a quantifiable effect on the measured voltage; and therefore must be accounted for to accurately 'correct' your reading:

- **Receiving antenna(s)**
- **Preamplifier(s)**
- **Coaxial measurement cable(s)**
- **Attenuation Pad(s)**
- **Connecting Adapter(s)**
- **Low-Pass, High-Pass or Notch Filter(s)**
- **DC Block(s)**
- **Other similar measurement components**

We can separate the factors associated with the above components into three basic categories:

- 1) Antenna (or transducer) Factors,**
- 2) Gain Factors (for preamplifiers); and,**  
the cables, attenuators, adapters, filters, etc., can all be lumped into one general category...
- 3) Insertion Loss Factors**

These three categories of correction factors are discussed in the following sections.

Most of today's spectrum analyzers and EMI receivers allow entry of these factors directly into the instrument. You can then group the factors into factor sets. This makes things very convenient, and allows the instrument to display/output test results as the corrected values, with no further correction necessary. These newer instruments will also allow you to enter the specification limits, so that PASS/FAIL can be determined instantaneously.

Older instruments, however, do not have this capability, so manual correction, or correction through data acquisition PC software (or other means) is needed.

Whatever the case may be, applying the *CORRECT* correction factors is obviously key to achieving accurate results. A simple typo when entering factors into your instrument or PC software will give you incorrect data *every time a test is performed* until such time that you notice the mistake, or until you recalibrate and enter the new factors. It is a good idea to double-check your entries.

## 4.1 Antenna Factors

Your AL-130R Active Loop Antenna is provided with two sets of active antenna factors; Electric Field (E-field) Factors and Magnetic Field (H-Field) Factors. The relationship between E-field and H-Field is given below.

$$\begin{matrix} \text{H-Field} \\ \text{(magnetic field)} \end{matrix} = \begin{matrix} \text{E-Field} \\ \text{(electric field)} \end{matrix} - \begin{matrix} 51.5 \text{ dB}\Omega \\ (\text{Log}^{-1} [377\Omega]) \end{matrix} \quad \dots\text{or, in linear terms:} \quad \begin{matrix} \text{H-Field} \\ \text{(magnetic field)} \end{matrix} = \frac{\text{E-Field (electric field)}}{377\Omega (20*\text{Log}[51.5 \text{ dB}\Omega])}$$

Determining which factor is to be used will depend on the measurement units used to define the specification limit.

If the limit is expressed in terms of magnetic field (Amps per meter), then the magnetic (H-Field) factors should be used.

If the limit is expressed in terms of electric field (Volts per meter), then the electric (E-Field) factors should be used.

In either case (E or H-Field), the factor is added to the measured value in order to convert, or correct your measured value.

$$\begin{matrix} \text{H-Field Strength} \\ \text{(dB}\mu\text{A/m)} \end{matrix} = \begin{matrix} \text{Measured Voltage} \\ \text{(dB}\mu\text{V)} \end{matrix} + \begin{matrix} \text{Active H-Field Antenna Factor} \\ \text{[dB}(\Omega/\text{m})] \end{matrix}$$

$$\begin{matrix} \text{E-Field Strength} \\ \text{(dB}\mu\text{V/m)} \end{matrix} = \begin{matrix} \text{Measured Voltage} \\ \text{(dB}\mu\text{V)} \end{matrix} + \begin{matrix} \text{Active E-Field Antenna Factor} \\ \text{[dB}(\text{m}^{-1})] \end{matrix}$$

### ELECTRIC FIELD EQUATIONS (VOLTS per meter)

$$\begin{aligned} \text{V/m} &= \text{[H-Field] Strength (A/m)} \times 377\Omega \\ \text{dBV/m} &= \text{[H-Field] Strength (dBA/m)} + 51.5 \\ \text{dBV/m} &= \text{Current (dBA)} - \text{[E-Field] Factor} + 51.5 \text{ dB} \\ \text{dBV/m} &= \text{Current (dBA)} - \text{[H-Field] Factor} \\ \text{dBV/m} &= \text{Voltage (dBV)} + \text{[E-Field] Factor} \end{aligned}$$

### MAGNETIC FIELD EQUATIONS (AMPS per meter)

$$\begin{aligned} \text{A/m} &= \text{[E-Field] Strength (V/m)} / 377\Omega \\ \text{dBA/m} &= \text{[E-Field] Strength (dBV/m)} - 51.5 \\ \text{dBA/m} &= \text{Voltage (dBV)} + \text{[E-Field] Factor} - 51.5 \\ \text{dBA/m} &= \text{Voltage (dBV)} + \text{[H-Field] Factor} \end{aligned}$$

## 4.2 Preamplicifier Gain Factors

Our second category of correction factors are gain factors for preamplifiers. Preamplifiers are used to increase measurement sensitivity by increasing signal to noise ratio. This is necessary when measuring low signal levels which would otherwise be buried below the inherent noise floor of the measuring instrument, typically a spectrum analyzer or EMI receiver. Ideally, input signals levels are increased proportionate to the preamp's gain, without significantly increasing the overall system noise level.

The AL-130R is an Active Loop Antenna, and contains an internal preamplifier, so additional signal amplification should not be needed. Additionally, the preamplifier gain values are included in either factor set, so no additional measurement correction is necessary.

### **4.3 Insertion Loss Factors**

As discussed previously, our third category of correction factors is insertion loss factors. These factors can include the insertion loss values of coaxial cables, band-pass or notch filters, attenuation pads, connecting adapters, etc. Basically, it includes any measurement system component (cable, adapter, combiner, divider or any other device) installed in-line with your measurement path having inherent insertion loss over the frequency range of the measurements, intentionally or unintentionally, beyond that which is considered to be negligible.

If the exact insertion loss factors (or values) are unknown for one or more component(s) of your measurement system, refer to section 4.3.1.

Insertion loss factors (or values) must be added to the measured values in order to obtain the 'corrected' values. So, we can update our field strength calculation formula as follows:

### 4.3.1 Insertion Loss Measurement

Insertion Loss values for coaxial cables and most measurement system components having a single coaxial input and output, such as attenuators, filters, dc blocks, etc., can be easily determined through a simple calibration process.

All that is typically needed is the following:

- ✓ (2) short coaxial cables and 'barrel' adapter to connect them together; and,
- either:
  - ✓ a network analyzer or measuring instrument (spectrum analyzer or EMI receiver) with tracking generator;
- or:
  - ✓ a measuring instrument (spectrum analyzer or EMI receiver); and,
  - ✓ a stable signal source with the appropriate frequency capabilities, such as a signal generator, function generator, or even a Com-Power Comb Generator.

#### 4.3.1.1 Insertion Loss Measurement Procedure

- 1) REFERENCE MEASUREMENTS **(R)** - With the equipment set up as shown in Figure 3, measure and record the signal level (*in dBμV*) at several frequencies over the frequency range to be calibrated.

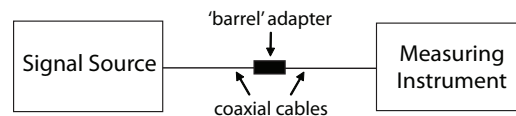

**FIGURE 7 - Setup for Reference Measurements (R)**

- 2) INSERTION LOSS MEASUREMENTS **(I)** - Without changing any equipment settings, and with the equipment set up as shown in Figure 4, measure and record the signal level (*in dBμV*) at the same frequencies used in Step 1.

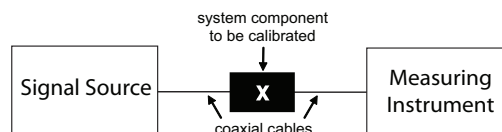

**FIGURE 8 - Setup for Insertion Loss Measurements (I)**

- 3) Calculate the insertion loss factor (in dB) for each frequency using the following formula:

$$\text{Insertion Loss Factor} = \text{(R) minus (I)}$$



## 5.0 Using your AL-130R Loop Antenna

### 5.1 Field Strength Measurement Calculations

As discussed in section 4, the measured values must be corrected for preamplifier gain and any losses incurred along the measurement path.

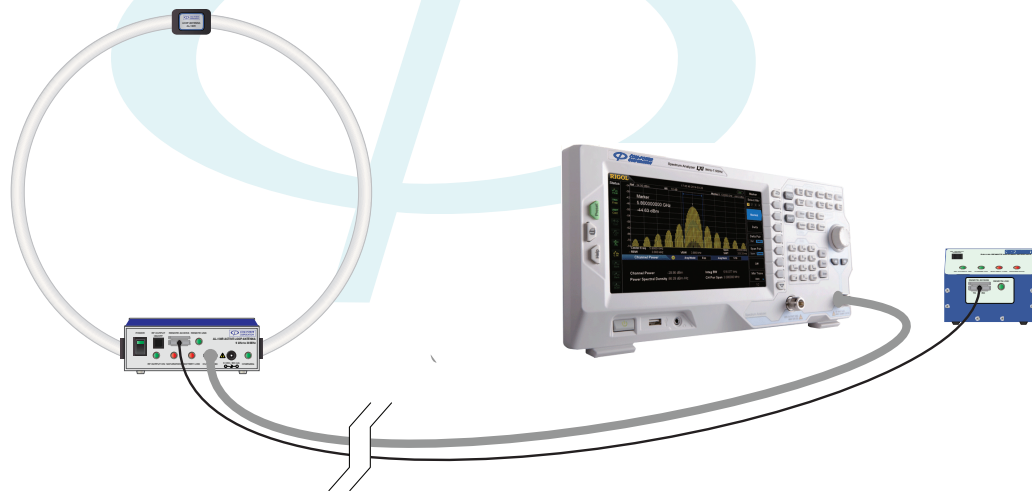

**FIGURE 9 - Typical measurement system for AL-130R**

Let's go through two sets of example calculations. In the first example, we will convert an uncorrected voltage measurement into a electric field strength for comparison to the FCC Part 15.209 limit of  $30 \mu\text{V/m}$  ( $29.5 \text{ dB}\mu\text{V/m}$ ) at 30 meters distance. And, in the second, we will convert the same uncorrected voltage value into a magnetic field strength for comparison to the CISPR 11 magnetic field strength limit of  $3 \text{ dB}\mu\text{A/m}$  at a 3-meter distance.

**EXAMPLE:**

We'll use the measurement system shown in Figure 9, and assume a 3-meter separation distance between the source and the antenna. We observe a signal at 30 MHz using the spectrum analyzer, and its [uncorrected] amplitude is exactly 38 dBμV.

For the system shown above, there are three (3) correction factors needed:

- 1) The AL-130R Active *E-Field* Antenna Factor
- 2) The AL-130R Active *H-Field* Antenna Factor
- 3) The Insertion Loss Factor for the long cable connecting the AL-130R to the measuring instrument.

We'll assume that the insertion loss of the cable at 30 MHz is 2 dB. And, by referring to the typical antenna factor tables in Section 8, we see that the *Active E-Field Factor is 12.58 dB/m and the Active H-Field Factor is -38.92 dBΩ/m* (in practice, you will use your actual calibrated factors rather than the typical factors). **E-Field calculations:**

Measured amplitude @ 30 MHz, with a 3-meter separation distance =	38 dBμV
Active <i>E-Field</i> Antenna Factor @ 30 MHz =	12.58 dB/m
Insertion Loss of Long Coaxial Cable @ 30 MHz =	2 dB
<b>E-Field Strength</b> (dBμV/m) = Measured Voltage (dBμV) + Active <i>E-Field</i> Antenna Factor (dB/m) + Cable Loss (dB) =	<b>52.58 dBμV/m</b> <b>@ 3 meters</b>
Distance factor (30 meters to 3 meters) =	40 dB
<b>Equivalent E-Field Strength @ 30 meters =</b>	<b>12.58 dBuV/m</b>
FCC Part 15 Field Strength Limit @ 30 meters =	29.5 dBμV/m
Limit Δ (margin) =	<b>-16.92 dB</b>

**And, the H-Field calculations:**

Measured amplitude @ 30 MHz, with a 3-meter separation distance =	38 dBμV
Active <i>H-Field</i> Antenna Factor @ 30 MHz =	-38.92 dBΩ/m
Insertion Loss of Long Coaxial Cable @ 30 MHz =	2 dB
<b>H-Field Strength</b> (dBμA/m) = Measured Voltage (dBμV) + Active <i>H-Field</i> Antenna Factor (dBΩ/m) + Cable Loss (dB) =	<b>1.08 dBμA/m</b> <b>@ 3 meters</b>
CISPR 11 H-Field Strength Limit @ 3 meters =	3 dBμA/m
Limit Δ (margin) =	<b>-1.92 dB</b>

## 5.2 Antenna Positioning

As per most regulatory test procedures, the loop antenna is positioned at a fixed, 1-meter height above the ground, with a separation distance of three and thirty meters from the Equipment Under Test (EUT).

The reference point, at which the height above the ground is measured, varies from standard to standard. Typically, it is either at the center-point of the loop (ANSI C63.4), or at the bottom of the loop (CISPR 11).

Rotating of the loop about its vertical axis (as shown in Figure 10), in an exploratory manner in order to obtain the highest amplitude, is typically required. And, in some cases, rotating of the loop about its horizontal axis (as shown in Figure 11), may also be required, depending on the test standard.

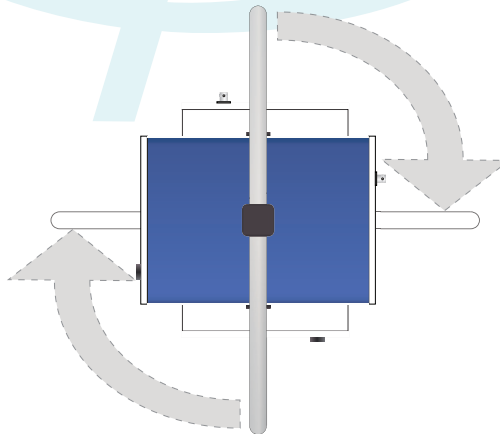

**FIGURE 10 - Rotation of Loop about its Vertical Axis**

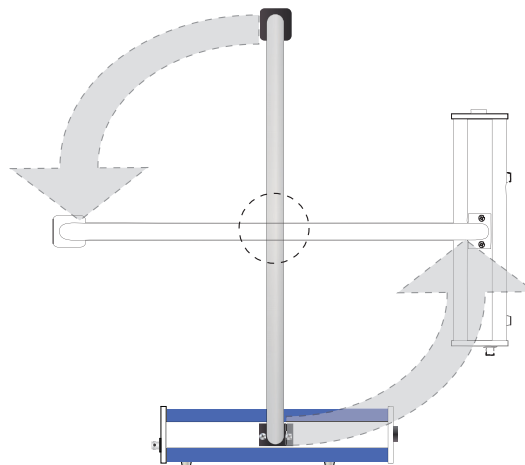

**FIGURE 11 - Rotation of Loop about its Horizontal Axis**

### 5.3 Using RAI-100 Remote Antenna Interface Unit

Locate the RAI-100 Remote Antenna Interface in a convenient, conspicuous location near the measurement equipment. Connect the supplied AC adapter to an appropriate power source, and connect the plug end of its cord into the RAI-100.

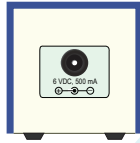

Secure the AL-130R Loop Antenna into position for the measurements. Connect the AL-130R to the RAI-100 Remote Antenna Interface Unit using the supplied fiber optic cable as shown in Figure 12.

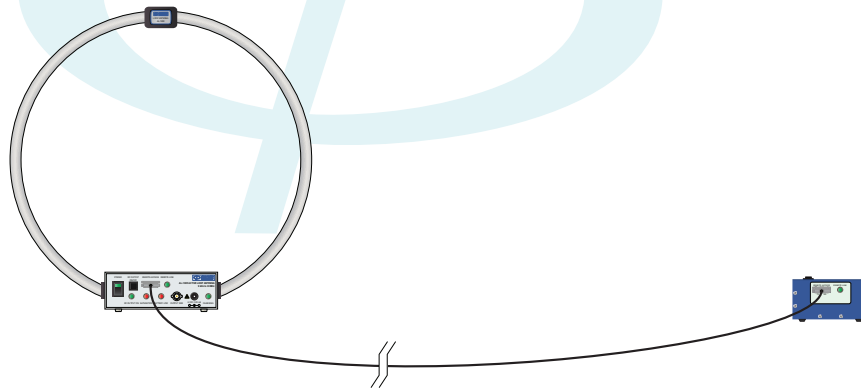

**FIGURE 12 - Fiber Optic Connection from AL-130R to RAI-100**

Once connected, the link will be established automatically. Once the link has been established, the green REMOTE LINK LED indicator on both the RAI-100 and AL-130R should both be lit.

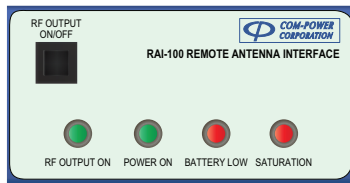

Now, turn on the Active Antenna's RF Output by pushing the RF OUTPUT ON/OFF pushbutton on the RAI-100 (or on the AL-130R). As long as the RF OUTPUT ON LED Indicator is lit, and the red SATURATION LED indicator is NOT lit, your loop antenna is ready to measure. If the SATURATION

LED indicator turns on during the test, the magnitude of the field is outside of the antenna's dynamic range, which can cause measurement inaccuracies due to unintended, non-linear operation. Avoid making measurements whenever possible when the SATURATION indicator is lit.

---

## 6.0 Calibration and Re-Calibration

Your AL-130R Active Loop Antenna has been individually calibrated with NIST traceability, and the appropriate data and certificate has been provided.

Periodic re-calibration of the AL-130R is recommended. Calibration intervals is left to your discretion, but should be chosen based on the frequency with which it is used, and/or as allowed for by your internal quality control system (if applicable).

Com-Power offers NIST traceable calibration services. Recognized ISO 17025 accredited calibrations are also available.

## 7.0 Warranty

Com-Power warrants to its Customers that the products it manufactures will be free from defects in materials and workmanship for a period of three (3) years. This warranty shall not apply to:

- Transport damages during shipment from your plant.
- Damages due to poor packaging.
- Products operated outside their specifications.
- Products Improperly maintained or modified.
- Consumable items such as fuses, power cords, cables, etc.
- Normal wear
- Calibration
- Products shipped outside the United States without the prior knowledge of Com-Power.

In addition, Com-Power shall not be obliged to provide service under this warranty to repair damage resulting from attempts to install, repair, service or modify the instrument by personnel other than Com-Power service representatives.

Under no circumstances does Com-Power recognize or assume liability for any loss, damage or expense arising, either directly or indirectly, from the use or handling of this product, or any inability to use this product separately or in combination with any other equipment.

When requesting warranty services, it is recommended that the original packaging material be used for shipping. Damage due to improper packaging will void warranty.

If you feel that the product is not working as intended, or is malfunctioning, please contact Com-Power for assistance. If the product must be returned to Com-Power, a Return Merchandise Authorization (RMA) number will be supplied to you. The RMA number should be displayed in a prominent location on the packaging and on the product, along with a description of the problem, and your contact information.

## 8.0 Typical Performance Data



### Active Loop Antenna Calibration 9 kHz to 30 MHz

Antenna Type:		Active Loop Antenna	
Model:		AL-130R	
Serial Number:		typical data	
Seperation Distance:		1 meter	
Calibration Date:		typical day for calibration	
Frequency (MHz)	[Magnetic] Antenna Factor [dB(Ω/m)]	[Electric] Antenna Factor [dB(m <sup>-1</sup> )]	
0.009	-35.42	16.08	
0.01	-35.83	15.67	
0.02	-36.62	14.88	
0.03	-36.52	14.98	
0.04	-36.98	14.52	
0.05	-37.75	13.75	
0.06	-37.45	14.05	
0.07	-37.58	13.92	
0.08	-37.36	14.14	
0.09	-37.55	13.95	
0.1	-37.56	13.94	
0.2	-37.79	13.71	
0.3	-37.82	13.68	
0.4	-37.76	13.74	
0.5	-37.79	13.71	
0.6	-37.82	13.68	
0.7	-37.70	13.80	
0.8	-37.52	13.98	
0.9	-37.41	14.09	
1	-37.42	14.08	
2	-37.11	14.39	
3	-37.12	14.38	
4	-37.20	14.30	
5	-36.99	14.51	
6	-37.21	14.29	
7	-37.13	14.37	
8	-36.89	14.61	
9	-36.90	14.60	
10	-36.79	14.71	
15	-37.18	14.32	
20	-36.87	14.63	
25	-38.64	12.86	
30	-38.92	12.58	