

# CT Analyzer

Current transformer testing, calibration and assessment



# Analyze your current transformer (CT) with the push of a button

## How CT Analyzer works

- > Injects low test signals into secondary side of the CT
- > Determines the CT's equivalent circuit parameters
- > Identifies all relevant CT performance parameters
- > Displays all relevant parameters of the CT and its accuracy at different currents and burdens
- > Evaluates the CT according to the selected standard
- > Determines unknown CT nameplate parameters
- > Demagnetizes the CT after the test

## Range of measurements

- > Ratio and phase accuracy
- > Winding resistance
- > Excitation characteristics (knee points)
- > Composite error (ALF, ALFi, FS, FS<sub>i</sub>, V<sub>p</sub>)
- > Burden impedance
- > Transient CT classes and parameters (TPS, TPX, TPY and TPZ type CTs)
- > Transient dimensioning factor (Ktd)
- > If missing/unknown: CT type, class, ratio, knee point, power factor, nominal burden, operating burden, primary and secondary winding resistance
- > Remanence and residual magnetism
- > Immediate good/bad evaluation

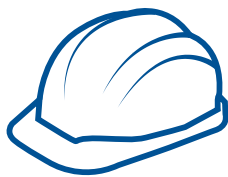

**SAFE**  
low test signals

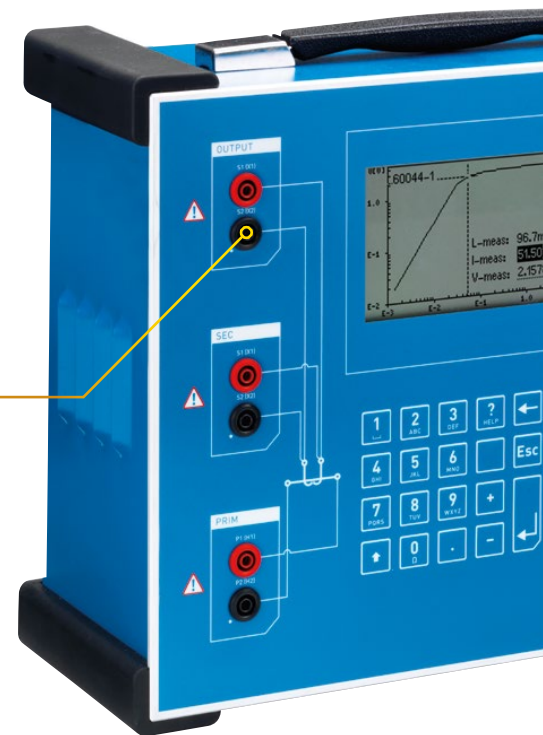

## Additional features

### > Simulate different burdens and currents

Will a change in the burden influence the accuracy of the measured CT? You can simply have CT Analyzer recalculate results for different burdens and primary currents without measuring again.

### > Analyze the effect of CT saturation

You can export the measurement results to network simulation software such as RelaySimTest or NetSim in order to analyze the protective system behavior under the effect of CT saturation.

### > Measure VT ratio

You can perform ratio measurements of inductive voltage transformers (VTs).

### > Multimeter

You can use the integrated multimeter with AC/DC current and voltage source for manual tests, such as L, Z, R, ratio, polarity and burden.



**EASY**  
one-button-test



**PROVEN**  
users in more  
than 120 countries



# Current transformer testing from production to maintenance

## Testing along the production line

- > Test CTs before adding the insulation
- > Verify CTs at various production stages
- > Achieve a high degree of automation
- > Use a universal interface to control the CT Analyzer from your very own production line software
- > Easily integrate the CT Analyzer into your company network and ERP system
- > Maximize your throughput by minimizing testing time
- > Reliably operate the CT Analyzer 24/7

## Factory acceptance testing

- > Determine the performance of the CTs and evaluate it according to the desired standard (IEC, IEEE or local)
- > Create a CT Analyzer fingerprint measurement for further on-site comparison
- > Verify the CT design



TEST



ASS

designed, tested and calibrated by OMICRON

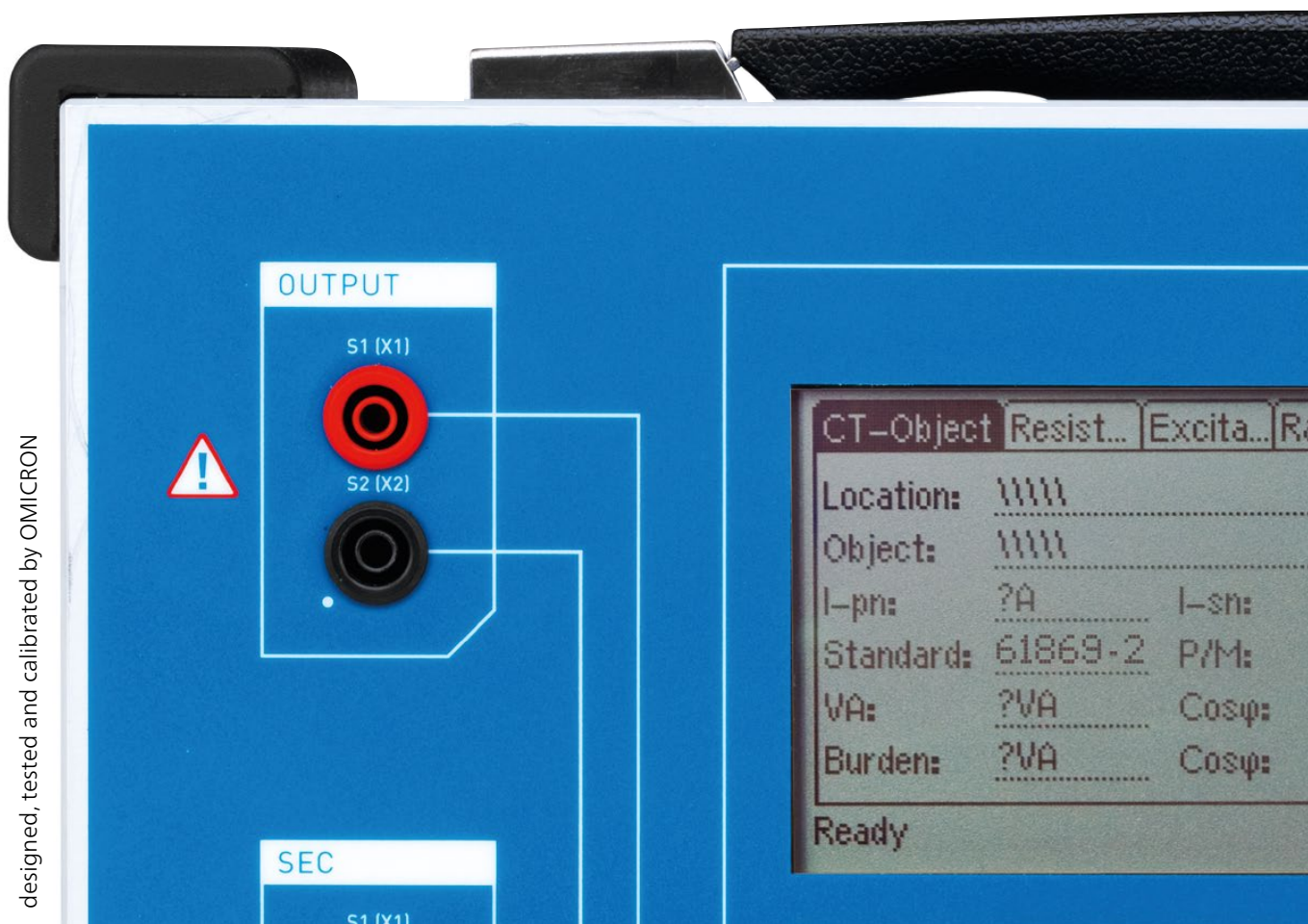

### Commissioning

- > Quickly and reliably commission any CT (all protection and metering classes)
- > Compare your results with factory measurements
- > Verify the connection and polarity of the secondary wiring along all of the connection points from the CT secondary terminals to the connected instrument, such as a relay or meter

### Maintenance

- > Verify the CT at (different) operating conditions
- > Recover unknown CT nameplate data
- > Verify correct wiring and connections
- > Compare your results with previous results
- > Create customized reports (digital or printed)
- > Analyze the cause of a protection failure based on the determined CT parameters
- > Evaluate protection system behavior under CT saturation using real CT data with network simulation software such as RelaySimTest or NetSim
- > Achieve stable and reliable results, even under harsh environmental conditions



**ESS**

**CALIBRATE**

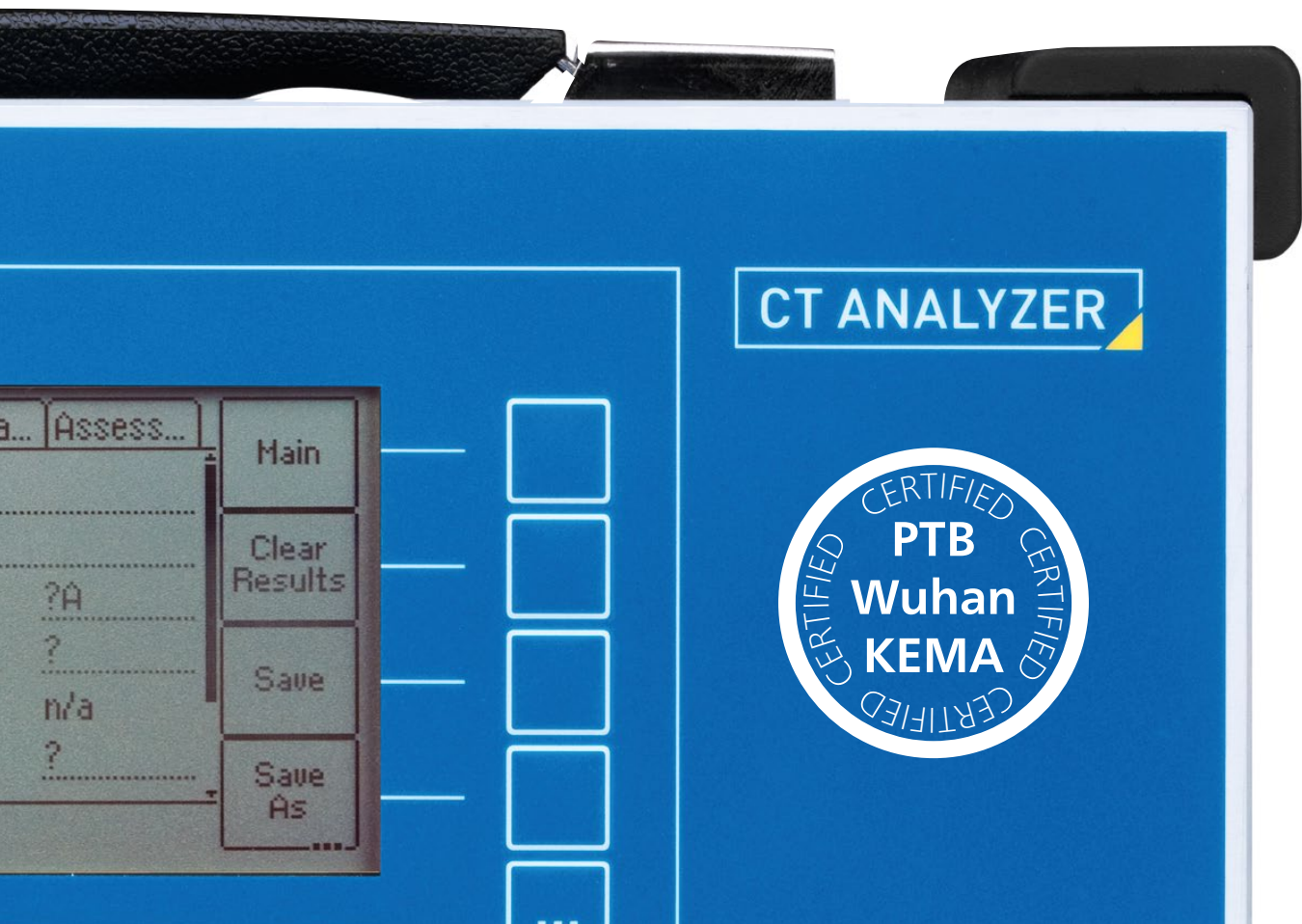

# Advantages and disadvantages of different CT testing methods

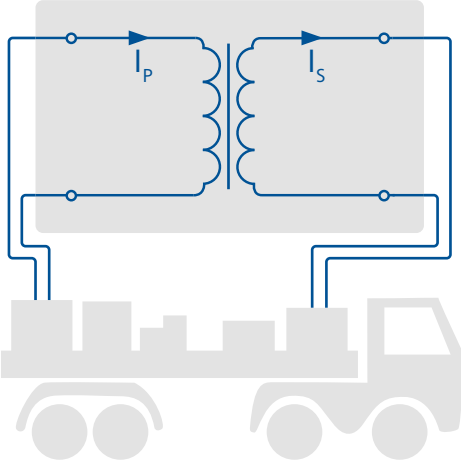
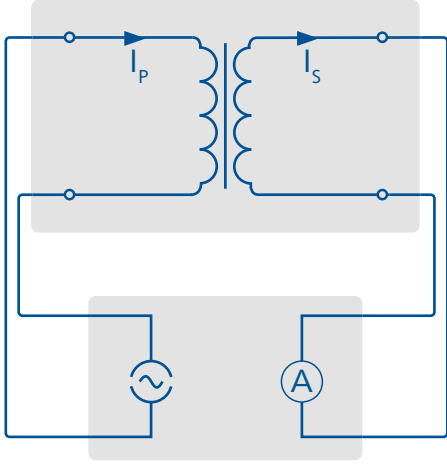
Method	Primary nominal current injection	Primary current injection
Setup	<ul style="list-style-type: none"> <li>&gt; Reference transformers and measuring bridges</li> </ul>	<ul style="list-style-type: none"> <li>&gt; Test set for current supply and measurement</li> </ul>
Usage	<ul style="list-style-type: none"> <li>&gt; Used in factories, calibration laboratories and on-site mounted on a test truck</li> </ul>	<ul style="list-style-type: none"> <li>&gt; Used during commissioning if high accuracy is not required</li> </ul>
Principle		
Safety	<ul style="list-style-type: none"> <li>&gt; Performed with very high currents (nominal and overcurrent magnitudes)</li> </ul>	<ul style="list-style-type: none"> <li>&gt; Currents up to 1000 A</li> </ul>
Accuracy	<ul style="list-style-type: none"> <li>&gt; High accuracy</li> </ul>	<ul style="list-style-type: none"> <li>&gt; Insufficient for high-accuracy metering CTs</li> <li>&gt; Sensitive to transient distortion if line frequency test signals are being used</li> </ul>
Mobility	<ul style="list-style-type: none"> <li>&gt; ~ Two tons of equipment (test truck, high-current source, heavy cables, current box, ...)</li> </ul>	<ul style="list-style-type: none"> <li>&gt; ~ 30 kg / 66 lbs (without additional equipment such as a burden box)</li> </ul>
Handling	<ul style="list-style-type: none"> <li>&gt; The heavy equipment requires several people to set up and perform the test</li> </ul>	<ul style="list-style-type: none"> <li>&gt; Rewiring is required between single tests (for example, ratio, polarity, saturation, winding resistance)</li> <li>&gt; Results must be assessed manually</li> </ul>

## Secondary voltage injection

- > Test set for voltage output and measurement of voltage and current
- > Used during commissioning or maintenance if a simple check of the CT's integrity from the secondary side is sufficient

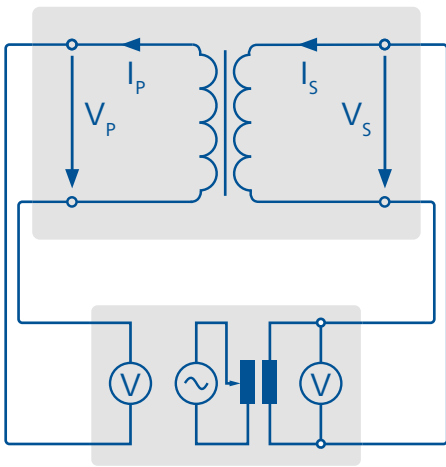

- > Voltages up to 2 kV or more
- > Insufficient for high-accuracy CTs
- > Sensitive to transient distortion if line frequency test signals are being used
- > ~ 20 kg / 44 lbs
- > Test results must typically be evaluated manually
- > Special attention has to be given to high-voltage leads and connections

## Model-based testing

- > Test set for low test signal injection and CT modelling
- > Used in all stages of a CT's life

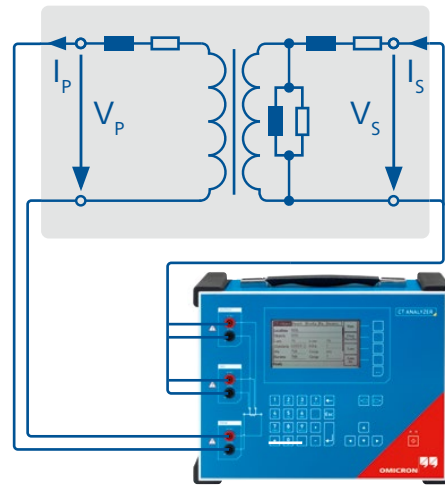

- > Output voltages up to 120 V
- > Suitable for all classes, including class 0.1
- > ~ 8 kg / 17 lbs
- > One-button test
- > Automated assessment
- > Integrated report
- > Fast (< 1 min)

# Operating the CT Analyzer: standalone or from a laptop

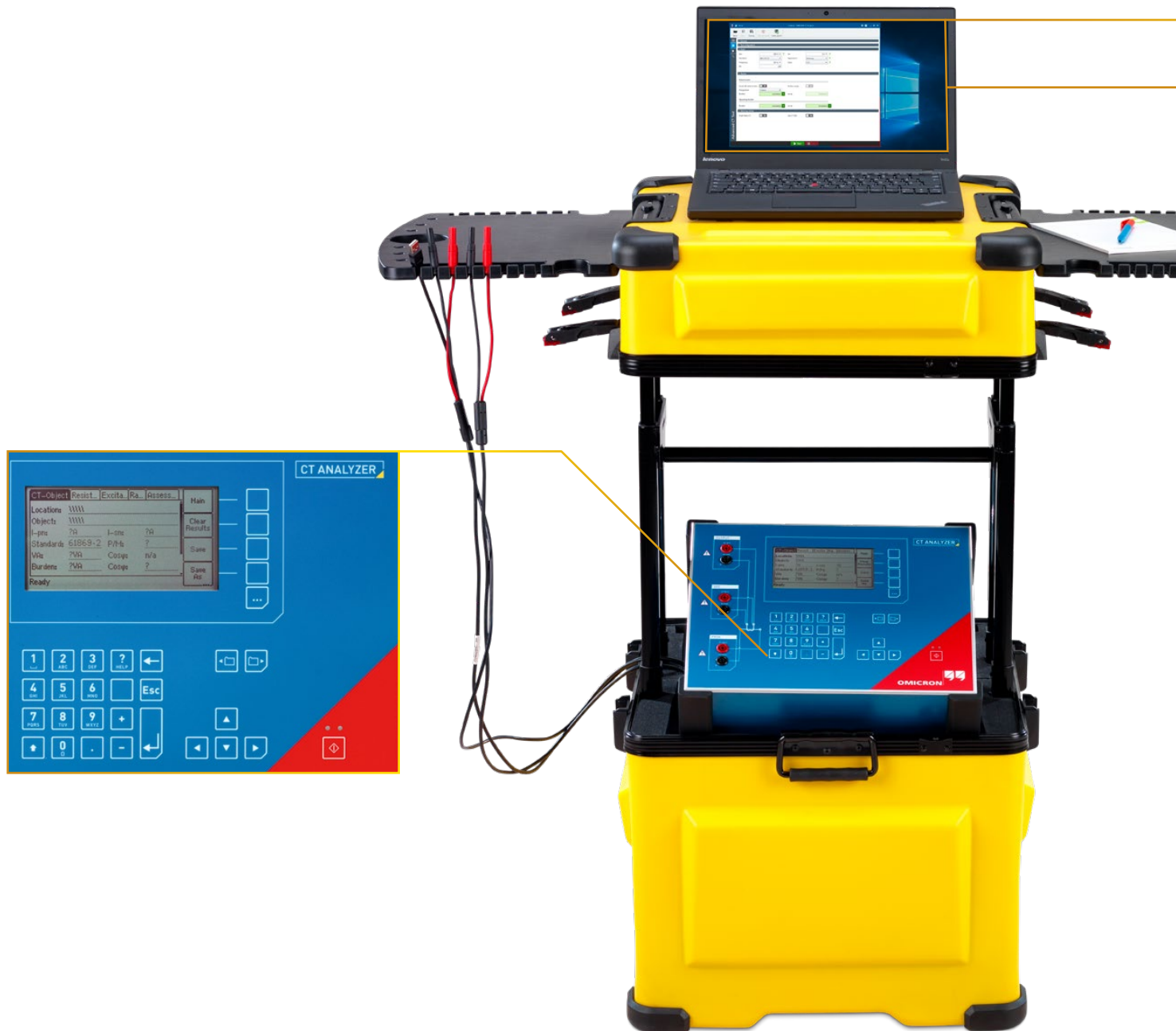

\* optionally available transport case

## Possible operations via front panel and PC

- > Input of CT parameters
- > Measurement and analysis
- > Automated assessment
- > Wiring diagrams and step-by-step instructions

## Additional operations via PC

- > Assessment standards and limits definition
- > Guided test preparation
- > Detailed connection diagrams
- > Automatic generation and display of reports
- > Customization of the report templates
- > Improved multi-ratio CT testing performance



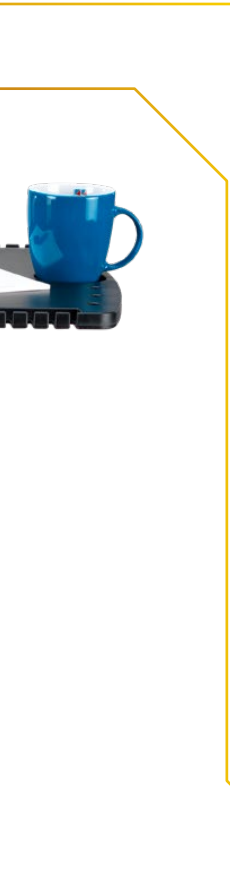

Home Untitled - OMICRON CT Analyzer

Open Save Save as Clear all results Create report

**General**

**Test configuration**

**Asset**

Ipn: 800 A ? Isn: 5 A ?  
 Standard: IEEE C57.13 Application: Metering ?  
 Frequency: 60 Hz Class: 0.15 ?  
 RF: 2,00

**Burden**

**Rated burden**

Assess @ rated burden:  Burden range:   
 Designation: Custom  
 Burden: Autodetect x cos φ: Autodetect

**Operating burden**

Burden: Autodetect x cos φ: Autodetect x

**Multi-tap details**

Multi Ratio CT:  Use CT SB?:

Start Stop

Home Untitled\* - OMICRON CT Analyzer

Open Save Save as Clear all results Create report

**Standard**

Standard: IEEE C57.13 Class: 0.15  
 Overall assessment: OK

**Assessment details**

**Secondary Winding Resistance**

R-meas: 126,129 mΩ T-meas: 25,0 °C I-DC: 5,020 A  
 R-ref: 150,431 mΩ T-ref: 75,0 °C V-DC: 632,115 mV

**RCF TCF**

**IEEE error parallelogram**

Primary current percentage/burden	RCF	Phase [min]
200 % / 12,50 VA	1,001	7,332
200 % / 5,00 VA	1,000	0,283
200 % / 2,50 VA	1,000	0,354
100 % / 12,50 VA	1,001	0,363
100 % / 5,00 VA	1,000	0,533
100 % / 2,50 VA	1,000	0,579
5 % / 12,50 VA	1,001	3,855
5 % / 5,00 VA	1,001	2,072
5 % / 2,50 VA	1,001	2,408

**Excitation**

Standard: IEEE C57.13  
 Top Ratios V kn I kn  
 10 X1-X2

Start Stop

## Optionally available accessories

### CT SB2: Switch box for multi-tap CT testing

- > Automates your testing of multi-tap CTs
- > No need for rewiring
- > Measures CTs with up to six taps in one test run
- > Determines all of the transformer ratios of all winding combinations automatically
- > Separate connections for primary resistance measurement and for the measurement of the secondary burden
- > Automatically verifies the cabling before measuring
- > Use it separate from, or attached to, CT Analyzer



### CPOL2: Polarity checker

- > Verifies correct polarity along all of the different terminals from the CT's secondary wiring all the way to the relay, meter or other secondary device
- > The polarity is verified using a sawtooth signal injected by the CT Analyzer running QuickTest





### Multi-functional transport case

- > Heavy duty transport case on wheels
- > Protection from dust and water drops
- > Protection from mechanical damage
- > Suitable for unattended shipping
- > Convertible into a workbench
- > Extendable lid and pluggable end plates



### Trolley / Backpack

- > Small and lightweight backpack carrying option
- > Wheels, extendable handle and shoulder straps
- > Basic mechanical protection

# Technical specifications

## CT Analyzer



### Accuracy

Ratio 1 ... 2000	error 0.02 % (typical) / 0.05 % (guaranteed)
Ratio 2000 ... 5000	error 0.03 % (typical) / 0.1 % (guaranteed)
Ratio 5000 ... 10000	error 0.05 % (typical) / 0.2 % (guaranteed)

### Phase displacement

Resolution	0.01 min
Accuracy	1 min (typical) / 3 min (guaranteed)

### Winding resistance

Resolution	1 mΩ
Accuracy	0.05 % (typical) / 0.1 % + 1 mΩ (guaranteed)

### Power supply

Input voltage	100 V <sub>AC</sub> ... 240 V <sub>AC</sub>
Permissible input voltage	85 V <sub>AC</sub> ... 264 V <sub>AC</sub>
Frequency	50 / 60 Hz
Permissible frequency	45 Hz ... 65 Hz
Input power	500 VA
Connection	Standard AC Socket IEC 60320

### Output

Output voltage	0 ... 120 V
Output current	0 ... 5 A <sub>eff</sub> (15 A <sub>peak</sub> )
Output power	0 ... 400 VA <sub>eff</sub> (1500 VA <sub>peak</sub> )

### Mechanical data

Size (W × H × D)	360 × 285 × 145 mm / 9.2 × 7.2 × 3.7 in
Weight	8 kg / 17.4 lbs (without accessories)

### Environmental conditions

Operating temperature	-10 °C ... +50 °C / 14 °F ... 122 °F
Storage temperature	-25 °C ... +70 °C / -13 °F ... 158 °F
Humidity	Relative humidity 5 % ... 95 % not condensing

### Certificates from independent test institutes

KEMA Test Report
PTB Test Report
Wuhan HV Research Test Report

## CT SB2

Input Current	0.2 A
Dimensions (W × H × D)	284 × 220 × 68 mm / 11.2 × 8.7 × 2.7 in
Weight	5.7 lbs / 2.6 kg



## CPOL2

Measuring range	250 μV <sub>RMS</sub> ... 300 V <sub>RMS</sub>
Evaluated signal form	Polarity test signal with slope ratio ≥ 3:1
Nominal frequency	52.6 Hz
Input impedance	> 300 kΩ
Batteries	2 × 1.5 V Mignon LR6 AA AM4 MN1500
Dimensions (W × H × D)	180 × 55 × 35 mm / 7.1 × 2.2 × 1.4 in
Weight	150 g / 0.33 lb

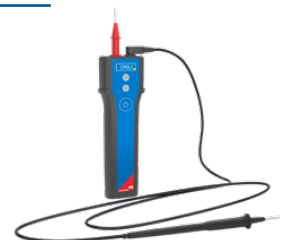

# Firmware Packages and Upgrades

		Basic	Standard	Advanced	IEEE Protection
<b>In brief</b>	Measures ratio, composite error, excitation and knee point, winding resistance	■			
	Measures and assesses CTs with accuracy classes $\geq 0.3$ according to IEC and IEEE standards		■		
	Expands standard package to accuracy classes $\geq 0.1$ and additional assessment standards			■	
	Measures protection CTs according to IEEE C57.13 (does not support metering CTs)				■
<b>Firmware Features</b>	CT secondary wiring phase and polarity measurements	■	■	■	■
	Composite error measurements for nominal current	■	■	■	■
	Ratio error and phase displacement measurement for no load and rated load	■	■	■	■
	Measurement of excitation characteristics (voltage/current)				
	> Knee point voltage from 1 V up to 4 kV	■	■	■	■
	> Knee point voltage from 0.1 V up to 40 kV	–	–	■	–
	> Automated calculation of knee points according to IEC and IEEE	■	■	■	■
	> Comparison of excitation curve to a reference curve	–	■	■	■
	CT winding resistance measurement (primary and secondary)	■	■	■	■
	CT accuracy measurements (ratio 1...25000) (ratio error and phase displacement depending on burden and current)				
	> IEC 61869 / 60044, or IEEE C57.13 classes $\geq 0.3$	–	■	■	■
	> IEC 61869 / 60044, or IEEE C57.13 classes $\geq 0.1$	–	–	■	–
	> Customized standards or local / national standards	–	–	■	–
	Automatic assessment of CT performance according to the selected standard	–	■ <sup>1</sup>	■	■
	Customization of assessment rules (for example implementation of national standards)	–	–	■	–
	Composite error measurement for overcurrent conditions (ALF/ALFi, FS/FSi for IEC and $V_b$ for IEEE)	–	■	■	■
	Determination of ALF and FS for IEC or $V_b$ for IEEE	–	■	■	■
	Secondary burden measurement	■	■	■	■
	„Nameplate guesser“ function for CTs with unknown data	–	■	■	■
	Simulation of measured data	–	–	■	■
	Measurement of transient behavior of TPS, TPX, TPY and TPZ type CTs	–	–	■	–
	Determination of the transient dimensioning factor (Ktd)	–	–	■	–
	Considering Duty Cycles C-O / C-O-C-O, for example auto-reclosure system	–	–	■	–
Automatic demagnetization of the CT after the test	■	■	■	■	
Remote control with CT Analyzer Suite software	■	■	■	■	
Flexible manual current and voltage source (QuickTest)	–	■	■	■	
Testing of CTs for line frequencies of 50 Hz	■	■	■	–	
Testing of CTs for line frequencies of 60 Hz	■	■	■	■	
CT SB2 (switch box) for measurements of CTs with up to 6 taps, including accessories	□	□	□	■	
CPOL2 for verifying the correct polarity of the secondary wiring along all connection points	□	□	□	□	
Remalyzer software for measuring the residual magnetism in CTs	□	□	□	□	
<b>Firmware Upgrades</b>	Basic -> Standard	Upgrades Basic to Standard Package			VESM0658
	Basic -> Advanced	Upgrades Basic to Advanced Package			VESM0659
	Standard -> Advanced	Upgrades Standard to Advanced Package			VESM0653
	IEEE Protection -> Advanced	Upgrades IEEE Protection to Advanced Package			VESM0654

<sup>1</sup> IEC 61869-6 not supported ■ included □ optional – not included

# Packages, accessories and services

## Firmware packages including accessories

## Order number

<b>Basic</b>	For measurements such as ratio check, composite error, excitation and knee point, winding resistance	VE000659
<b>Standard</b>	For measurements and automatic assessment on CTs with accuracy classes $\geq 0.3$ according to IEC and IEEE standards	VE000656
<b>Advanced</b>	Expands standard package functionality to accuracy classes $\geq 0.1$ and additional assessment standards	VE000654



<b>IEEE Protection</b>	For protection CTs according to IEEE C57.13 (does not support metering CTs)	VE000657
------------------------	---	----------



## PC software features

	Free Standard Software	PC Software Upgrade Option (P0000413)
Guided test execution via PC	■	■
Detailed connection diagrams	■	■
Test reports	■	■
Convenient summary of test results	■	■
Advanced test reports (e.g. combination of multiple tests)	—	■
Report template design editor	—	■
Multi-test view	—	■
Results simulation without the need to connect the CT Analyzer	—	■

■ included □ optional — not included

Please find detailed ordering information and package descriptions on [www.omicronenergy.com](http://www.omicronenergy.com)

Accessories		Order number
CT SB2 including accessories		Switch box for measurements on CTs with up to 6 taps VEHZ0696
Training CT		Class 0.5 CT for training purposes, FS 5, ratio 300:5 VEHZ0643
Calibration CT		High-precision CT (class 0.02) for calibration purposes, ratios 2000:1 / 2000:5 VEHZ0649
Winding		Pluggable 23 turns winding for measurements on magnetic cores without secondary winding VEHK0658
CPOL2		Polarity checker for CTs' secondary wiring VEHZ0702
RemAnalyzer		Determines the residual magnetism in CTs (additional software license) VESM0657
Transport case with wheels		Suitable for unattended shipping VEHP0068
Multi-functional transport case		Suitable for unattended shipping. Convertible into a workbench. VEHP0028
Calibration services		Order number
Recalibration of high-precision CT	Recalibration of high-precision CT according to ISO / IEC 17025 (recommended every 1-2 years)	VEDK9055
Calibration of new CT Analyzer	Calibration of new CT Analyzer devices according to ISO / IEC17025 (certificates included)	VEDK9002
Recalibration of CT Analyzer in service	Recalibration of CT Analyzer according to ISO / IEC 17025 (includes certificates, recommended every 1-2 years)	VEDK9051

OMICRON is an international company serving the electrical power industry with innovative testing and diagnostic solutions. The application of OMICRON products allows users to assess the condition of the primary and secondary equipment on their systems with complete confidence. Services offered in the area of consulting, commissioning, testing, diagnosis and training make the product range complete.

Customers in more than 160 countries rely on the company's ability to supply leading edge technology of excellent quality. Service centers on all continents provide a broad base of knowledge and extraordinary customer support. All of this together with our strong network of sales partners is what has made our company a market leader in the electrical power industry.

Additional literature:



Please visit our website for more information and detailed contact information of our worldwide offices.