

INSTRUCTION MANUAL



MODEL 1670A



INSTRUCTION MANUAL MODEL 1670A Triple Output DC POWER SUPPLY



TEST INSTRUMENT SAFETY

WARNING

Normal use of test equipment exposes you to a certain amount of danger from electrical shock because testing must sometimes be performed where exposed high voltage is present. An electrical shock causing 10 milliamps of current to pass through the heart will stop most human heartbeats. Voltage as low as 35 volts dc or ac rms should be considered dangerous and hazardous since it can produce a lethal current under certain conditions. Higher voltages are even more dangerous. Your normal work habits should include all accepted practices to prevent contact with exposed high voltage, and to steer current away from your heart in case of accidental contact with a high voltage. Observe the following safety precautions:

1. There is little danger of electrical shock from the dc output of this power supply. However, there are several other possible test conditions using this power supply that can create a high voltage shock hazard:
 - a. If the equipment under test is the "hot chassis" type, a serious shock hazard exists unless the equipment is unplugged (just turning off the equipment does not remove the hazard), or an isolation transformer is used.
 - b. If the equipment under test is "powered up" (and that equipment uses high voltage in any of its circuits), the power supply outputs may be floated to the potential at the point of connection. Remember that high voltage may appear at unexpected points in defective equipment. Do not float the power supply output to more than 100 volts peak with respect to chassis or earth ground.
 - c. If the equipment under test is "off" (and that equipment uses high voltage in any of its circuits under normal operation), discharge high-voltage capacitors before making connections or tests. Some circuits retain high voltage long after the equipment is turned off.
2. Use only a polarized 3-wire ac outlet. This assures that the power supply chassis, case, and ground terminal are connected to a good earth ground and reduces danger from electrical shock.
3. Don't expose high voltage needlessly. Remove housings and covers only when necessary. Turn off equipment while making test connections in high-voltage circuits. Discharge high-voltage capacitors after removing power.

(Continued on inside back cover)

Instruction Manual
For
Model 1670A
Triple Output
DC POWER SUPPLY



BK PRECISION®

B&K Precision Corporation
22820 Savi Ranch Parkway
Yorba Linda, California 92887

TABLE OF CONTENTS

	Page		Page
TEST INSTRUMENT SAFETY.....	inside front cover	Constant Voltage/Current Characteristics.....	9
INTRODUCTION.....	1	12 Vdc Output.....	9
SPECIFICATIONS.....	2	5 Vdc Output.....	10
CONTROLS AND INDICATORS.....	5	Dual or Triple Output.....	10
OPERATING INSTRUCTIONS.....	7	Connecting Outputs in Series.....	10
Safety Precautions.....	7	MAINTENANCE.....	12
Equipment Protection Precautions.....	7	Fuse Replacement.....	12
Power Supply Hook-up and Operation.....	7	Instrument Repair Service.....	12
Variable Voltage Output.....	7	SERVICE INFORMATION.....	13
Typical Constant Voltage Output.....	8	LIMITED ONE-YEAR WARRANTY.....	14
Setting Current Limit.....	8	TEST INSTRUMENT SAFETY.....	inside back cover
Typical Constant Current Operation.....	8		

INTRODUCTION

The **B+K Precision** Model 1670A is a general purpose triple output DC power supply. Their main outputs are versatile constant voltage or constant current regulated power source that is variable from 0 to 30 volts and 0 to 3 amps. An indicator lights in the constant current mode, and serves as an overload indicator in the constant voltage mode.

While this model is competitively priced with most single output power supplies, they have the added advantage of fixed 5 volt and 12 volt outputs capable of providing up to 0.5 amps each. One common application for these power supply is powering of circuit boards while troubleshooting. Many circuit boards require two or three input voltages, with the most common values being 5 volts and 12 volts. These power supplies can provide up to three outputs simultaneously. Since each output is fully isolated, any output can be connected for positive or negative polarity.

The main output voltage and current are continuously monitored by two digital LCD meters with resolution of 0.1 volt and 0.01 amp.

The Model 1670A can operate continuously at its maximum rated output and is fully overload protected.

This manual provides the information to help assure the maximum performance and longest life for your power supply.

SPECIFICATIONS

OUTPUT NO. 1

VOLTAGE

Variable 0-30 VDC

CURRENT

0 to 3 Amps

POLARITY

Positive or Negative

CONNECTORS

Binding Posts

REGULATION TYPE

Constant Voltage or Constant Current

CONSTANT VOLTAGE MODE

LOAD REGULATION (0 to rated output)

$\leq 0.05\% + 10 \text{ mV}$

LINE REGULATION (108 TO 132 VAC)

$\leq 0.05\% + 10 \text{ mV}$

RIPPLE AND NOISE

$\leq 5 \text{ mV rms}$

CONSTANT CURRENT MODE

LOAD REGULATION

$\leq 0.4\% + 10 \text{ mA}$

LINE REGULATION (108 TO 132 VAC)

$\leq 0.4\% + 10 \text{ mA}$

RIPPLE AND NOISE

$\leq 10 \text{ mA rms}$

PROTECTION

Current limiting, short circuit protection, reverse polarity protection

VOLTAGE INDICATOR

3 digit LCD

VOLTAGE RESOLUTION

0.1 V

VOLTAGE ACCURACY

$\pm (1\% \text{ reading} + 2 \text{ digit})$

CURRENT INDICATOR

3 digit LCD

AMMETER RESOLUTION

$\pm 0.01 \text{ A}$

AMMETER ACCURACY

$\pm (1\% \text{ reading} + 2 \text{ digit})$

OUTPUT NO. 2

VOLTAGE

Fixed 12 VDC $\pm 5\%$

CURRENT

0 to 500 mA continuous

POLARITY

Positive or Negative

CONNECTORS

Wire clips

LOAD REGULATION (no load to 500 mA)

$\leq 1\%$

LINE REGULATION

$\leq 1\%$

RIPPLE AND NOISE

≤ 5 mV rms

PROTECTION

Short circuit protection, thermal overload protection

OUTPUT NO. 3

VOLTAGE

Fixed 5 VDC $\pm 5\%$

CURRENT

0 to 500 mA continuous

POLARITY

Positive or Negative

CONNECTORS

Wire Clips

LOAD REGULATION (no load to 500 mA)

$\leq 1\%$

LINE REGULATION

$\leq 1\%$

RIPPLE AND NOISE

≤ 5 mV rms

PROTECTION

Short circuit protection, thermal overload protection

SPECIFICATIONS

COOLING

Variable speed thermal static control fan

AC INPUT

115/230 VAC, 50/60 Hz~ (~Alternate current)

POWER CONSUMPTION

165W

OPERATION TEMPERATURE

0° TO 40° C, 10-80%R.H.

(80% relative humidity for temperature up to 31° C
decreasing linearly to 50% relative humidity at 40° C)

STORAGE TEMPERATURE

-15° TO 70° C, ≤ 85% R.H.

ENVIRONMENTAL CONDITIONS

- 10-80% R.H.
- Altitude up to 2000m
- Installation category: CAT II
- Pollution degree: 2
- Mains supply voltage fluctuation up to ±10% of normal voltage

DIMENSIONS (H x W x D)

4.9" x 8.5" x 9.5" (124 x 216 x 242mm)

WEIGHT approx.

10 lbs (4.5 kg)

ACCESSORIES SUPPLIED

Instruction Manual

Spare fuse

OPTIONAL ACCESSORIES

Power Supply Hook-up Cables, Model TL 5A

LINE SELECTION

The 1670A can operate on 115V AC or 230V AC line input. Before connecting the power cord to the AC outlet, make sure the voltage selector on the bottom of the unit is set to the correct line voltage. Additionally, please check that you have the fuse inserted in the fuse box below the AC input receptacle. The fuse to use is referenced below:

LINE VOLTAGE	115V	230V
FUSE VALUE	F3AL250V	F1.6AL250V

CONTROLS AND INDICATORS

- 1. POWER Switch.** Turns power supply on and off.
"I" : power switch ON
"O" : power switch OFF
- 2. Power ON light.** Lights when power is turned on.
- 3. CURRENT LIMITED Indicator.** Lights when variable supply is operating in constant current mode.
- 4. CURRENT Control.** Adjusts maximum output current of variable supply. Read value on A meter
- 5. VOLTAGE Control.** Adjusts output voltage of variable supply. Read value on V Meter.
- 6. A Meter.** Indicates output current of variable supply.
- 7. V Meter.** Indicates output voltage of variable supply.
- 8. OUTPUT + Terminal (Red).** Positive polarity output terminal.
- 9. OUTPUT - Terminal (Black).** Negative polarity variable output terminal.
- 10. 12V OUTPUT + Terminal (red).** Positive polarity 12 VDC output terminal.
- 11. 12V OUTPUT - Terminal (black).** Negative polarity 12 VDC output terminal.
- 12. 5V OUTPUT - Terminal (black).** Negative polarity 5 VDC output terminal
- 13. 5V OUTPUT + Terminal (red).** Positive polarity 5 VDC output terminal.
- 14. POWER Input connector**
- 15. FUSE Holder**
- 16. DC Fan**

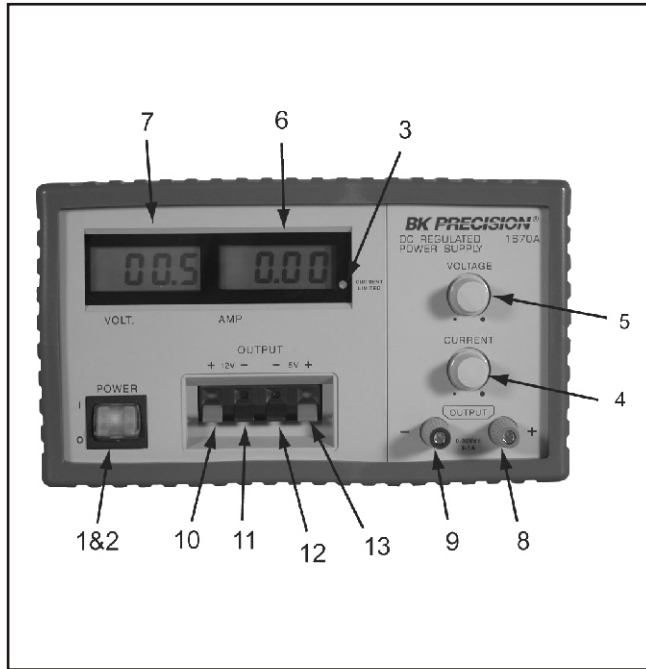

Figure 1. Front Panel Controls and Indicators, Model 1670A

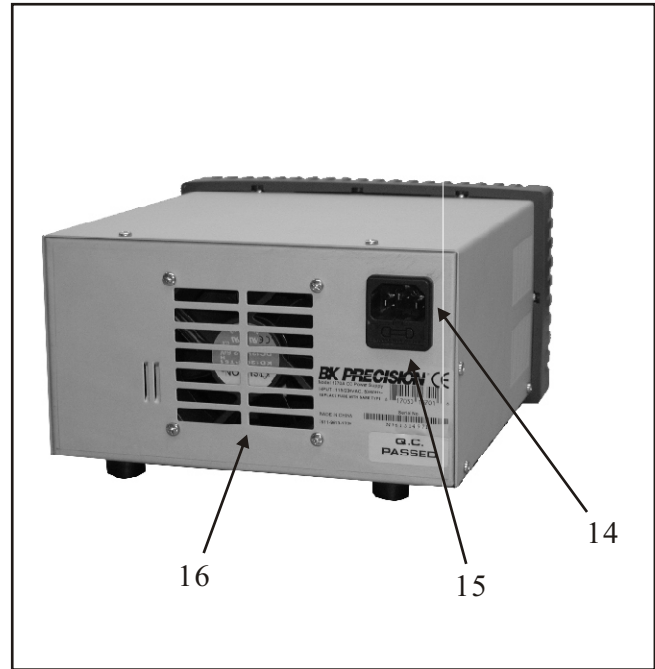

Figure 2. Rear Panel Model 1670A

OPERATING INSTRUCTIONS

SAFETY PRECAUTIONS

CAUTION

Use only a polarized 3-wire outlet. This assures that the power supply chassis and case are connected to a good earth ground and reduces danger of electrical shock

There is little danger of electric shock from the power supply output, which produces a maximum of 30 volts dc. However, there may be the great danger of electrical shock if the power supply output is connected to an external high voltage. Some equipment being powered may contain high voltage and present a shock hazard. Observe caution. If the power supply output is floated (referenced to a voltage rather than earth ground) turn off the power supply and the equipment under test when making connections. Never float the power supply to a potential greater than 100 volts peak with respect to earth ground.

Observe all TEST INSTRUMENT SAFETY precautions listed in the front of this manual.

EQUIPMENT PROTECTION PRECAUTIONS

Avoid using the power supply in ambient temperatures above +40°C (104°F). Always allow sufficient air space around the opening at the rear of the power supply and the top and side vent openings for effective air flow to prevent internal heat build-up. Typically, a two inch space at the sides, as well as a six inch space at the top and rear of the power supply is adequate. DO NOT block the fan opening at the rear of the power supply or

the vent on top of the power supply. DO NOT place objects on top of the power supply.

Protection provided by the equipment may be impaired if the equipment is used in a manner not specified by the manufacturer

Don't put this product in a position so that it is difficult to unplug the device from the appliance inlet

Unplug this product from the wall outlet before cleaning. Do not use liquid cleaners or aerosol cleaners. Use a damp cloth for cleaning.

Although the power supply is protected against overload and short circuits, avoiding these conditions in regular use results in maximum stability and reliability.

Make certain that hook-up is as intended before turning power supply on. Incorrect polarity may damage the equipment being powered.

For indoor use only.

POWER SUPPLY HOOK-UP and OPERATION

Variable Voltage Output

1. Turn off the power supply and equipment being powered.

NOTE

Use solid copper hook-up wire of at least 18 gauge. Using smaller wire may increase the source resistance "seen" by the load, thereby derating the regulation capabilities of the power supply. Tighten connections snugly to assure low resistance.

OPERATING INSTRUCTIONS

2. Connect the red (+) **OUTPUT** terminal of the power supply to the positive polarity input of the equipment being powered.
3. Connect the black (-) **OUTPUT** terminal of the power supply to the negative polarity input of the equipment being powered.
4. Place the **POWER** switch to the **ON** position, the **ON** indicator should illuminate,
5. Turn on the equipment being powered.

Typical Constant Voltage Operation

1. Before connecting the device to be powered to the power supply, determine the maximum safe load current for the device to be powered and set the current limit value (see "Setting Current Limit" procedure in the is section).
2. Set the **VOLTAGE** control to minimum (fully counterclockwise)
3. Turn off power supply and connect it to the device to be powered
4. Turn on **POWER** switch. The power **ON** indicator should light
5. Increase the **VOLTAGE** setting until the voltage display reads the desired value.
6. If the load current exceeds the preset current limit, the **CURRENT LIMITED** indicator will light. In this case, the power supply automatically switches to the constant current mode and further rotation of the **VOLTAGE** control will not increase the output current.

Setting Current Limit

1. Determine the maximum safe current for the device to be powered.
2. Rotate the **VOLTAGE** control away from zero until some low voltage (under 1 volt) is indicated.
3. Temporarily short the (+) and (-) **OUTPUT** terminals of the power supply together with a test lead
4. Adjust the **CURRENT** control for the desired current limit. Read the current value on the current display.
5. The current limit (overload protection) has now been preset. Do not change the **CURRENT** control setting after this step.
6. Remove the short between the (+) and (-) **OUTPUT** binding posts and hook up for constant voltage operation.

Typical Constant Current Operation

1. Before connecting the device to be powered to the power supply, determine the maximum safe voltage to be applied, and set the **VOLTAGE** control to obtain that voltage reading on the display.
2. Determine the desired constant current value.
3. Set the **CURRENT** control to minimum (fully counterclockwise).
4. Turn off the power supply and connect it to the device to be powered.
5. Turn on the power supply.
6. Increase the **CURRENT** control setting until the desired constant current value is read on the display, or set the current limit in advance (before connecting the load) as prescribed earlier in the "setting Current Limit" procedure.

7. If the load current reaches the constant current value, the **CURRENT LIMITED** indicator will light. If the load current drops below the constant current value, the **CURRENT LIMITED** indicator will go off. In this case the power supply automatically switches to the constant voltage mode, and further rotation of the **CURRENT** control will not increase the output current.

Constant Voltage/Constant Current Characteristic

The working characteristic of the variable power supply is called a constant voltage/constant current automatic crossover type. This permits continuous transition from constant current to constant voltage modes in response to the load change. The intersection of constant voltage and constant current modes is called the crossover point. Fig 3 shows the relationship between this crossover points and the load.

For example, if the load is such that the power supply is operating in the constant voltage mode, a regulated output voltage is provided. The output voltage remains constant as the load increases, up until the point where the preset current limit is reached. At that point, the output current becomes constant and the output voltage drops in proportion to further increases in load. The crossover point is indicated by the front panel **CURRENT LIMITED** indicator lighting.

Similarly, crossover from the constant current to the constant voltage mode automatically occurs from a decrease in load. A good example of this would be seen when charging a 12-volt car battery. Initially, the open circuit voltage of the power supply may be preset for 13.8 volts. A low battery will place a heavy load on the power supply and it will operate in the constant current mode, which may be adjusted of a 2 Amp charging rate. As the battery becomes charged, and its voltage approaches 13.8 volts, its load decreased to the point where it no longer demands the full 2 Amp charging rate. This is the crossover point where the power supply goes into the constant voltage mode.

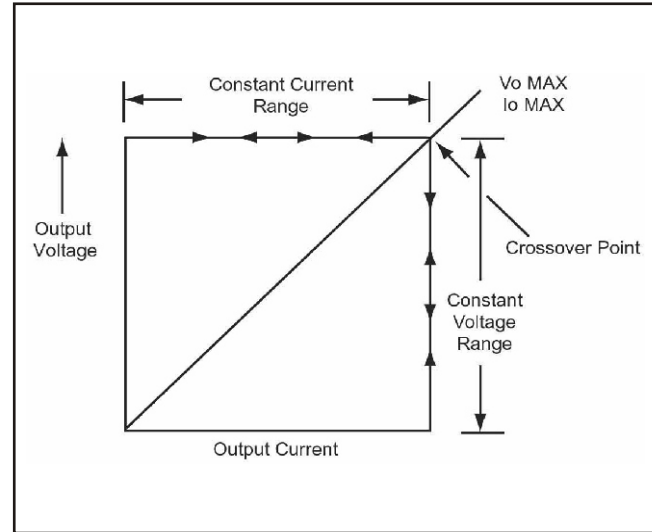

Figure 3. Constant Voltage/Current Characteristics

12 VDC Output

The 12 Vdc is a fixed voltage supply providing up to 500 mA (0.5 amp) continuous. The 12 Vdc output is available at the two left **OUTPUT 12V** tie points. Be sure to observe polarity.

5 VDC Output

The 5 Vdc is a fixed voltage supply providing up to 500 mA (0.5 amp) continuous. The 5 Vdc output is available at the two right **OUTPUT 5V** tie points. Be sure to observe polarity.

CAUTION

1. The 12V and 5V supplies will provide up to 1 amp for a short period, but thermal shutdown may occur when the output is overloaded for a few minutes. Upon thermal shutdown there will be now output. If thermal shutdown occurs, remove the load and wait 15 minutes for the power supply to cool. Normal operation may then resume.
2. Overloading May also cause sever ripple I the output which could disrupt operation of the circuit being powered. Excessive ripple will produce a loud hum in devices with speakers.
3. You can prevent overloading by measuring the output current with an external multimeter. Set the meter to measure current (a 2 amp range is desirable, or a 10 amp range may be used) and connect is "series" with the load. Load current up to 500 mA may be operated continuously, load current greater than 500 mA must be short term, maximum short term current is 1 amp.

DUAL OR TRIPLE OUTPUT

Two of the outputs, or all three of the outputs may be used simultaneously if desired. The three outputs are fully isolated from ground, and each other, thus each output may be connected for the either positive or negative polarity.

A typical example of a triple output application would be powering a circuit board that requires three voltages, such as +5, +12V and -12V. Fig. 4 shows how the outputs would be connected for this example, and the following procedures reviews the steps of hook-up.

1. The variable supply would be set for 12V. WE will assign the variable supply as the +12V source and the fixed 12V supply as the -12V source.
2. Connect the - terminal of the 5V supply to circuit board common and the + terminal to the +5V input of the board.
3. Connect the - terminal of the variable supply to circuit board common (or the terminal of the 5V supply). Connect the + terminal of the variable supply to the +12V input of the board.
4. Connect the + terminal of the fixed 12V supply to circuit board common (or the - terminal of the 5V and variable supplies). Connect the - terminal of the fixed 12V supply to the -12V input of the board.

CONNECTING OUTPUTS IN SERIES

When the 30 volt output of the variable supply is not adequate, the outputs may be connected in series to provide a variable 17 to 47 volt output. Since the supplies are connected in series, the maximum current is the same as for the fixed voltage supplies, that, 500 mA continuous or 1 amp peak. Connections for the configuration are shown in Fig. 5.

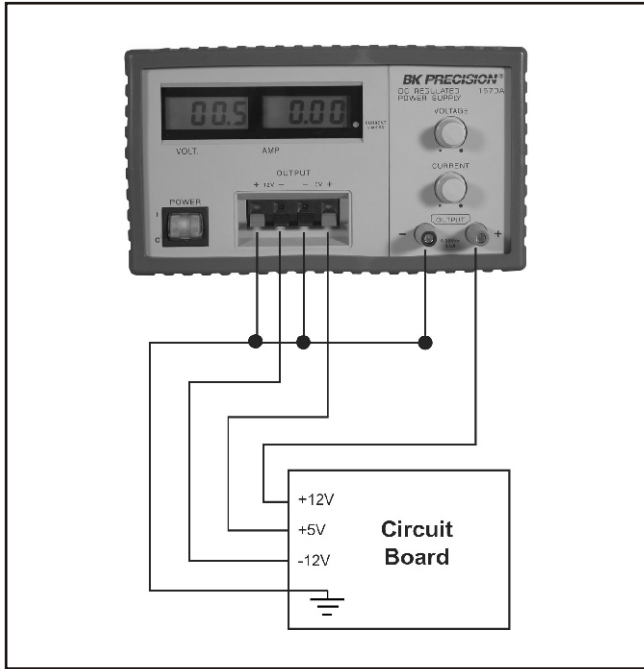

Figure 4. Example of Triple Output Hook-up for +5V, +12V, and -12V

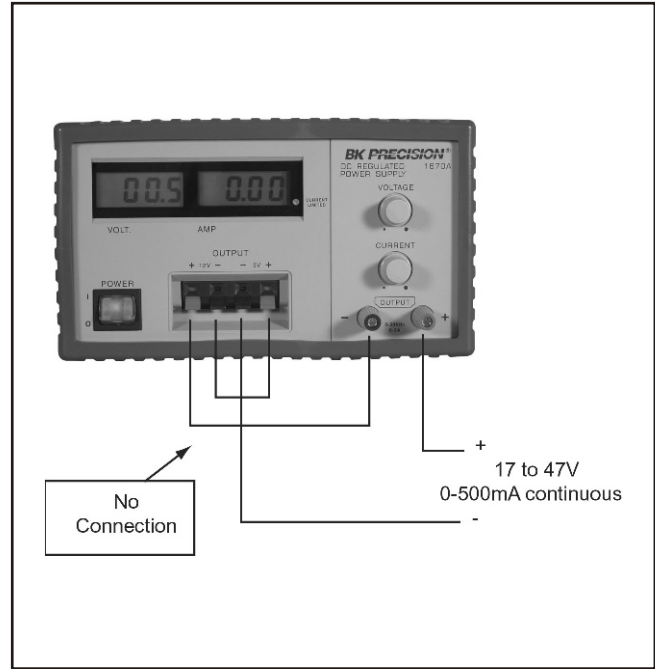

Figure 5. Connecting Outputs in Series for Variable 17 to 47 volt output

MAINTENANCE

WARNING

The following instructions are for use by qualified personnel only. To avoid electrical shock, do not perform any servicing other than contained in the operating instructions unless you are qualified to do so.

FUSE REPLACEMENT

If the fuse blows, the power on LED indicator will not light and the power supply will not operate. The fuse should not normally open unless a problem has developed in the unit. Try to determine and correct the cause of the blown fuse, then replace only with a fuse of the correct rating. The fuse is located on the rear panel (see Fig. 2).

LINE VOLTAGE	115V	230V
FUSE VALUE	F3AL250V	F1.6AL250V

INSTRUMENT REPAIR SERVICE

Because of the specialized skills and test equipment required for instrument repair and calibration, many customers prefer to rely upon **B & K Precision** for this service. We maintain a network of **B+K Precision** authorized service agencies for this purpose. To use this service, even if the instrument is no longer under warranty, follow the instructions given in the **WARRANTY SERVICE INSTRUCTIONS** section of this manual. There is a nominal charge for instruments out of warranty.



Service Information

Warranty Service: Please return the product in the original packaging with proof of purchase to the address below. Clearly state in writing the performance problem and return any leads, probes, connectors and accessories that you are using with the device.

Non-Warranty Service: Return the product in the original packaging to the address below. Clearly state in writing the performance problem and return any leads, probes, connectors and accessories that you are using with the device. Customers not on open account must include payment in the form of a money order or credit card. For the most current repair charges please visit www.bkprecision.com and click on "service/repair".

Return all merchandise to B&K Precision Corp. with pre-paid shipping. The flat-rate repair charge for Non-Warranty Service does not include return shipping. Return shipping to locations in North American is included for Warranty Service. For overnight shipments and non-North American shipping fees please contact B&K Precision Corp.

B&K Precision Corp.
22820 Savi Ranch Parkway
Yorba Linda, CA 92887
www.bkprecision.com
714-921-9095

Include with the returned instrument your complete return shipping address, contact name, phone number and description of problem.



Limited One-Year Warranty

B&K Precision Corp. warrants to the original purchaser that its products and the component parts thereof, will be free from defects in workmanship and materials for a period of one year from date of purchase.

B&K Precision Corp. will, without charge, repair or replace, at its option, defective product or component parts. Returned product must be accompanied by proof of the purchase date in the form of a sales receipt.

To obtain warranty coverage in the U.S.A., this product must be registered by completing a warranty registration form online at www.bkprecision.com within fifteen (15) days of purchase.

Exclusions: This warranty does not apply in the event of misuse or abuse of the product or as a result of unauthorized alterations or repairs. The warranty is void if the serial number is altered, defaced or removed.

B&K Precision Corp. shall not be liable for any consequential damages, including without limitation damages resulting from loss of use. Some states do not allow limitations of incidental or consequential damages. So the above limitation or exclusion may not apply to you.

This warranty gives you specific rights and you may have other rights, which vary from state-to-state.

B&K Precision Corp.
22820 Savi Ranch Parkway
Yorba Linda, CA 92887
www.bkprecision.com
714-921-9095

(Continued from inside front cover)

4. If possible, familiarize yourself with the equipment being tested and the location of its high voltage points. However, remember that high voltage may appear at unexpected points in defective equipment.
5. Use an insulated floor material or a large, insulated floor mat to stand on, and an insulated work surface on which to place equipment; and make certain such surfaces are not damp or wet.
6. When testing ac powered equipment, the ac line voltage is usually present on some power input circuits such as the on-off switch, fuses, power transformer, etc. "any time" the equipment is connected to an ac outlet, even if the equipment is turned off.
7. **B+K Precision** products are not authorized for use in any application involving direct contact between our product and the human body, or for use as a critical component in a life support device or system. Here, "direct contact" refers to any connection from or to our equipment via any cabling or switching means. A "critical component" is any component of a life support device or system whose failure to perform can be reasonably expected to cause failure of that device or system, or to affect its safety or effectiveness.
8. Never work alone. Someone should be nearby to render aid if necessary. Training in CPR (cardio-pulmonary resuscitation) first aid is highly recommended.



B+K PRECISION®

B&K Precision Corporation

22820 Savi Ranch Parkway

Yorba Linda, California 92887

www.bkprecision.com

©2005 B&K Precision Corporation

481-369-9-001

Printed in China

v043014